

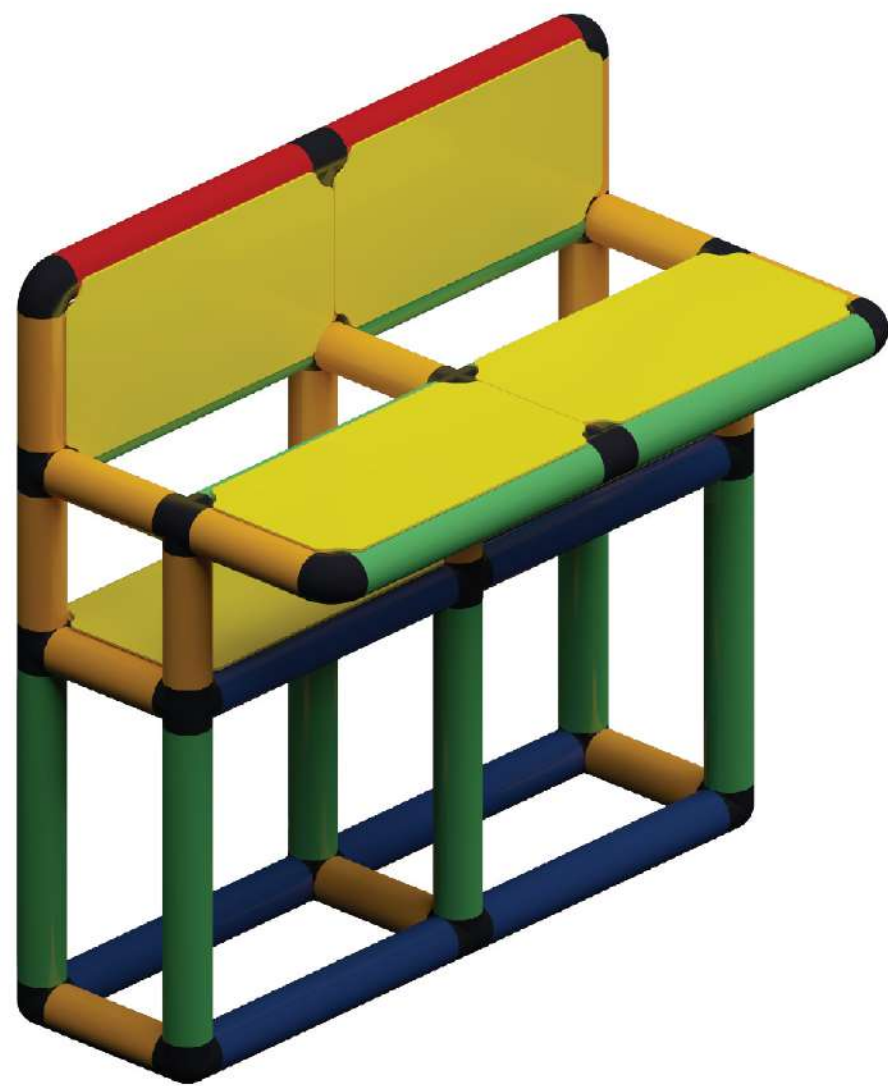

Build with it - Play on it™



# FUNPHIX CREATE AND PLAY LIFE-SIZE STRUCTURES DOLL SET



Before you begin to use this toy, you must read all the information in this manual.

## Warning:

Do not sit, stand, or climb or play on your structure until all screws are secured into their place. A screw must be inserted into the tube hole that aligns with the connector for the toy to be safe and secure. The screws must be inserted on both ends of each tube. The toy will fall apart without the screws in place.

- You can only apply weight on the panels, when you secure the panels with the panel screws, to the supporting tubes on all four sides. Never push the panels out from the inside, always remove them carefully by first removing screw fasteners .

- Throwing the panel may result in the panel chipping at the edges.

- All play structures need to be assembled and tested by an adult "supervisor", according to the instructions and safety standards listed below.

- The product is intended for home/domestic use only and is not suitable for professional or commercial use, nor for municipal playgrounds.

- When you assemble a play structure, follow the exact instructions in the manual.

- Place the bottom supports of play structure on a flat surface. Do not place your structure on an elevated or inclined surface, your play structure should always be at floor level or ground level.

- Whether used indoors or outdoors, place the structure on a safety floor material i.e. Carpet, mats grass ,shredded tire etc.

## Supervision and playing

1. An adult must always be present to watch over the children when they are building, playing or using the structures. Parents are liable for the children's actions.
2. Children Play on the play structures at their and their parent's own risk
3. Do not misuse the play structures, use it for the purpose it was intended.
4. The maximum weight on the structures is a total of 150Lbs.
5. No play should be allowed on structures which have not been completed, been damaged, or destroyed, or altered ,or partially or fully unassembled.
6. Do not use the play structure when the parts of the structure reach a temperature of 100 degrees F.
7. Ensure that the environment around the structure is safe and that no flame or heat producer or anything hazardous is near.
8. Do not use or store the product next to any fire.
9. Do not use any broken parts.
10. Do not throw the tubes or panels.

## Maintenance

- Inspect your play structure before each use, make sure there are no loose contents, missing parts, screws, or broken pieces. Any missing or damaged pieces should be replaced immediately.
- Maintain the pieces by periodically washing the play structures with warm water and a little detergent. Do not use any harsh detergent or compounds on the surfaces.
- The color of the plastic pieces may fade by sunshine, you can however use them indoors and outdoors. Store indoors, and if left outside for a long time make sure to cover it and protect everything with a cloth.
- Not following these guidelines is not only dangerous to children, but will also immediately void any warranty.

**Warning:**

This package has small parts that can be swallowed! Not for children under 3 years. There is danger of choking and/or suffocation!

**Parts list**

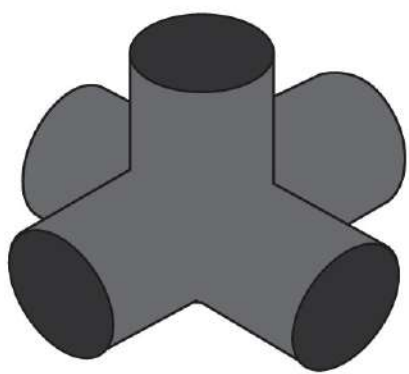

5 way connector  
Qty X2

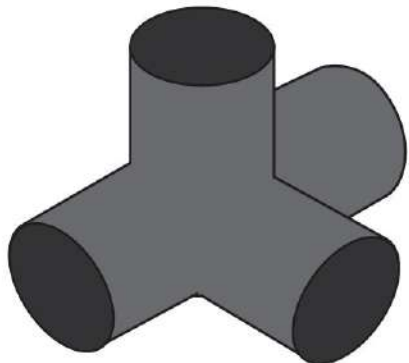

4 way connector  
Qty X10

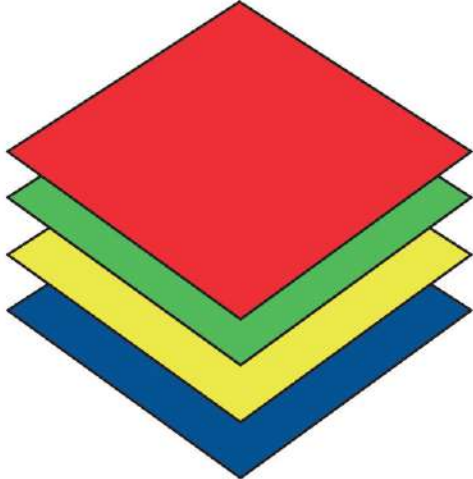

Colored Panel  
(15.55 Inches X 15.55inches)  
Qty X2



Girl doll x1

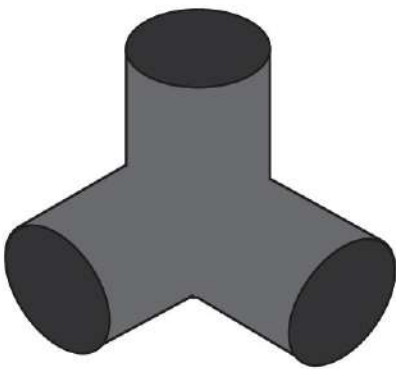

3 way connector  
Qty X8



T connector  
Qty X8



Tubes (13.58 Inches)  
Qty X22



Boy doll x1



Elbow connector  
Qty X8



2 way connector  
Qty X12



Screws  
Qty X104



Panel screw  
Qty X44

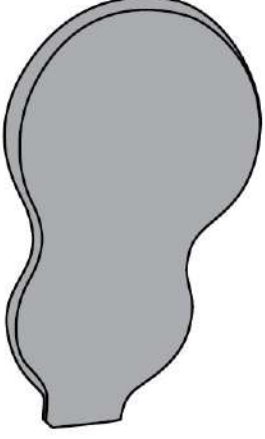

Key  
Qty X2



Tube (5.81 inches)  
Qty X26

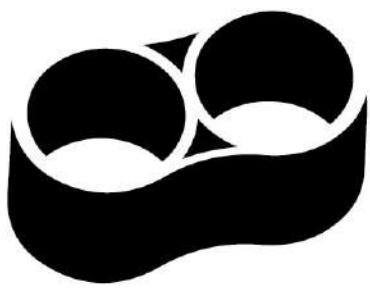

Duplex  
Qty X2



Wheel combination  
Qty X4



half panel  
Qty X9

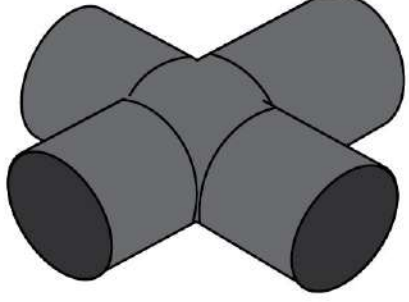

Cross connector  
Qty X1

## Instructions on How to assemble structures

- The screws are secured as well as removed by insertion of tube over connector followed by a screw through both tube and connector's aligned holes, followed by a 90 degree turn.

To detach the tube from the connector, first remove the screw by turning it back 90° then turn the tube slightly and remove it from the connector.

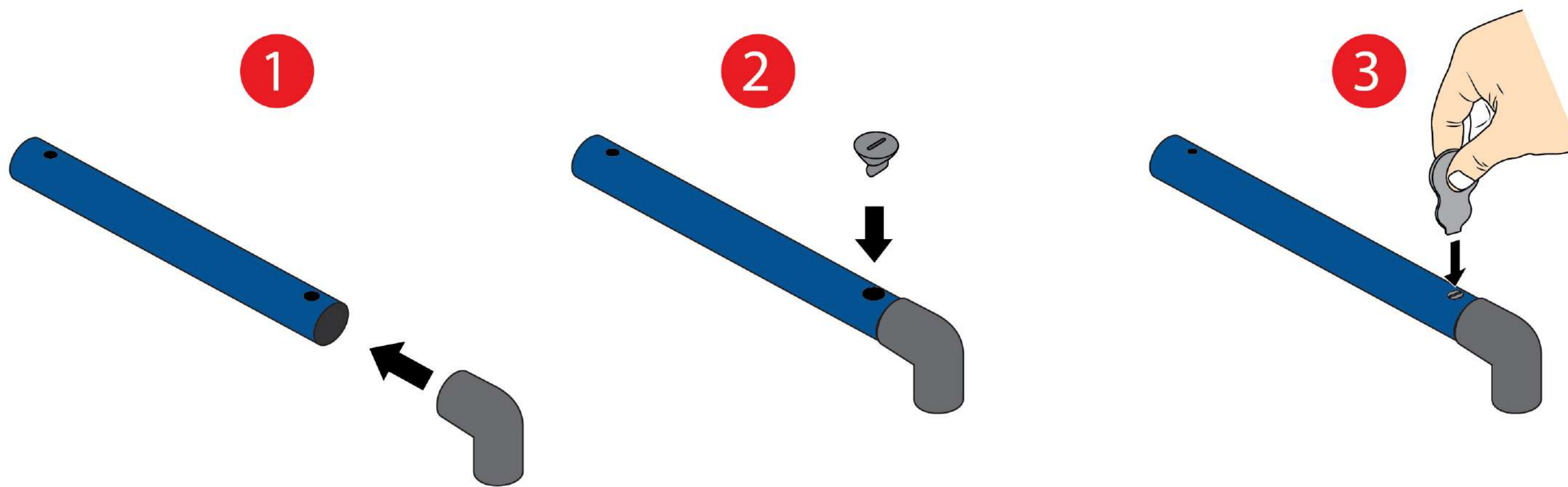

- It will be simpler to build a structure from the base up, complete the first level and then continue on to the next level just above. Insert the screws only after the structure is completely assembled. When inserting the screws, also work your way up starting from the bottom up completing upwardly each level.

- Prepare your structures of tubes and connectors beforehand, so that you will not have to force any pieces, See image below showing correct assembly and incorrect assembly.

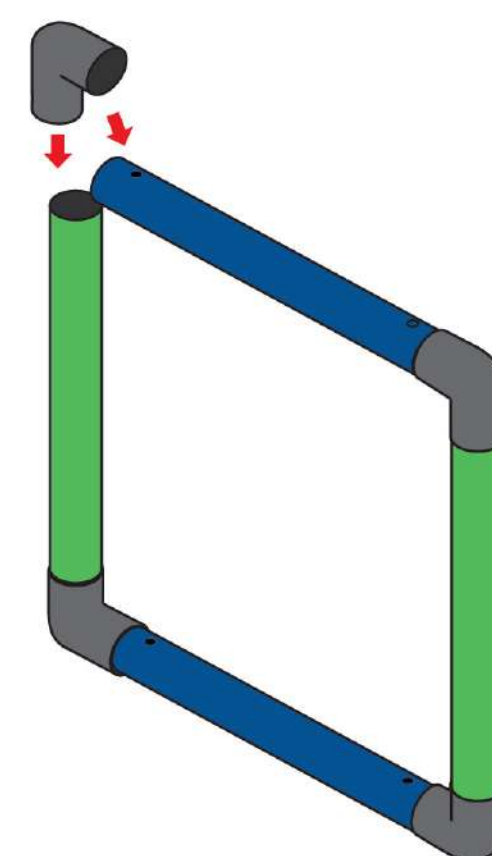
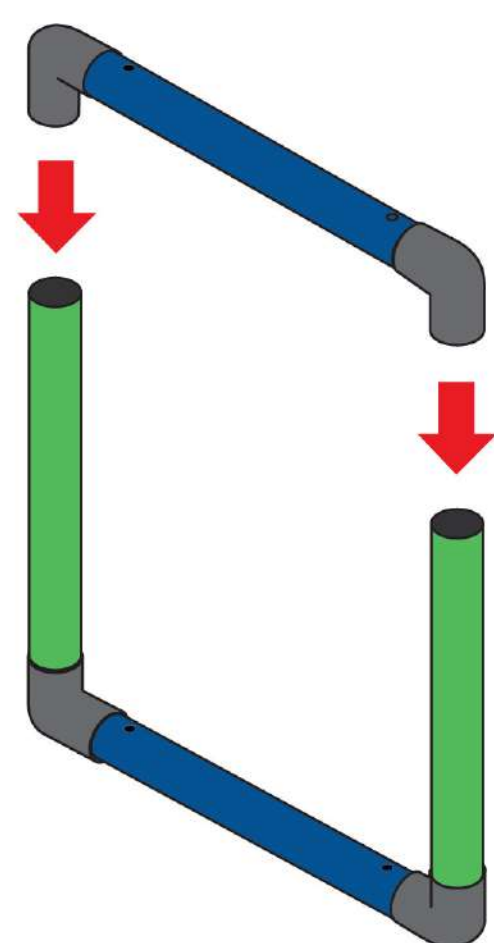

- Remember when inserting the screws for the tube and connector where you want to insert panels as those places will be secured by the required panel screws. Each tube only has 2 screw holes and therefore you will have to ensure that the panels are put extending in different directions when sharing the same tubes. So that you can insert the necessary panel screws in each panel hole and tube . See image below.

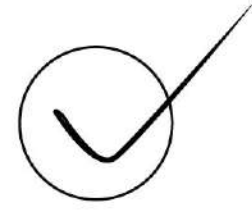

- When assembling your own structure, always make sure to build a stable support by adding to the width, as you are making the structure taller .

Make sure to test your self-designed structures to ensure they are stable and safe and will not tip over. Do not build tall or wobbly structures.

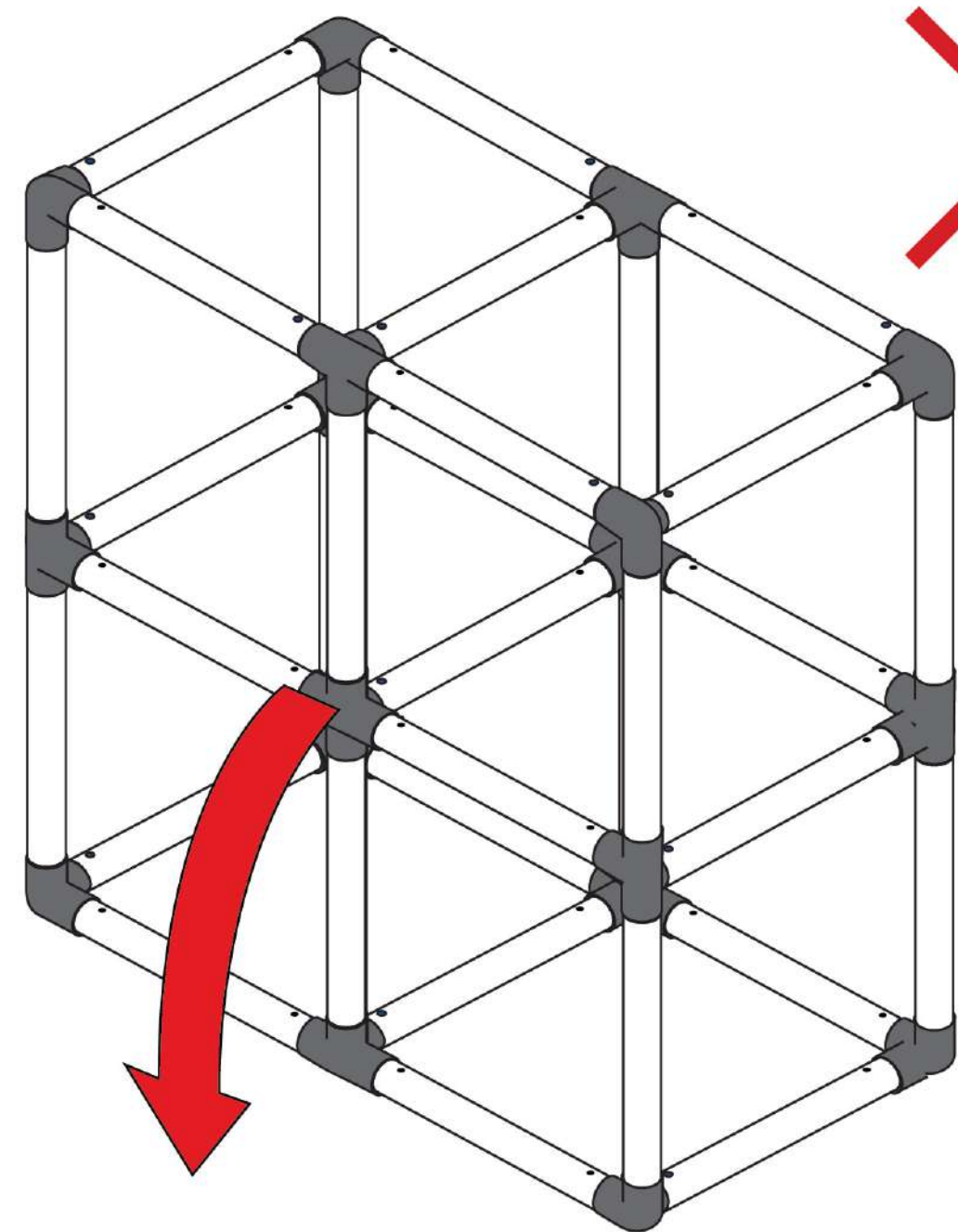
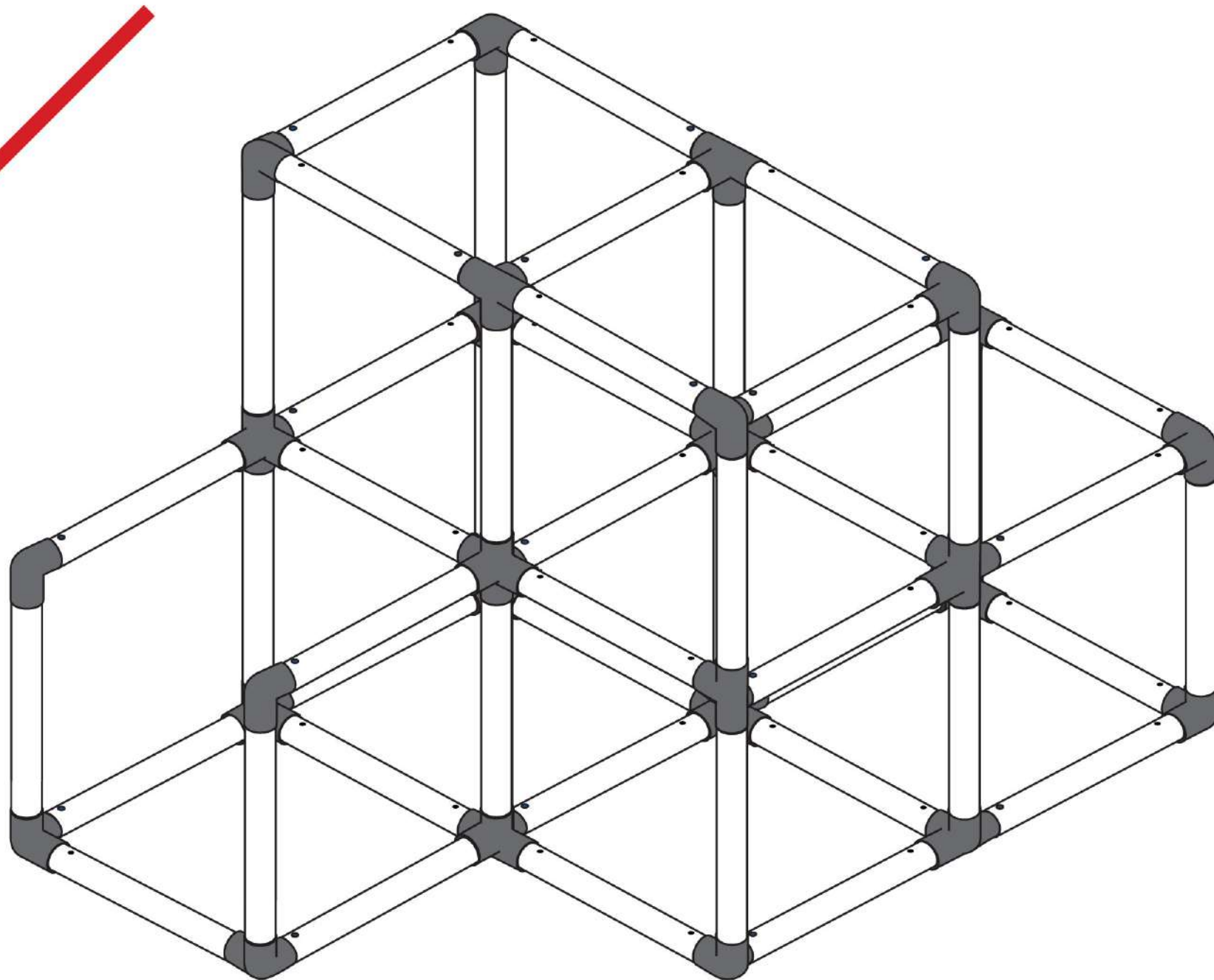

## Safety Instruction for Wheeled Structure.

- Parents/Adults should check the structure from time to time to ensure that the necessary screws are fastened tight.
- The wheels should be inspected to ensure that they are not loose; each one should be firmly attached to its tube.
- Do not ride your wheeled structure on bumpy surfaces.
- Wheeled structures should not be used near pools, roadways, alleys, hills, or holes
- The wheeled structure should not be used by more than two children at a time, do not allow more than the allowed weight.
- Ensure that all parts of the wheeled structure fitted to maintain balance are tightly fitted and that they are used properly by your children. This will allow for balance and stability during use of the wheeled structures.
- Ensure that your children remain seated while using the wheeled structure. Do not allow them to stand on the structure. Ensure that the structure has completely been brought to a stop before descending.
- Shoes should be worn while riding on the wheeled structure with the prescribed number of passengers riding each time. Passengers should remain seated with hands and legs within the wheeled structure.
- Sit only on the space provided for sitting.
- Do not use the wheeled structure on a wet surface.
- Ensure that the structure is not pushed from behind as it might lead to uncontrollable acceleration.
- Avoid accidents by ensuring that little children do not sit or crawl in the path of the wheeled structure.

See below illustrations if you need to assemble the parts of the wheel.



## Instructions on how to assemble structures with wheels

- First, build the structure with the tubes and connectors. Once the structure is fully assembled and the screws are secured in its place, only then will you add the wheels to the structure.
- Remember when building the structure, to always leave an end of the connector extending downward where you want to secure the wheels.

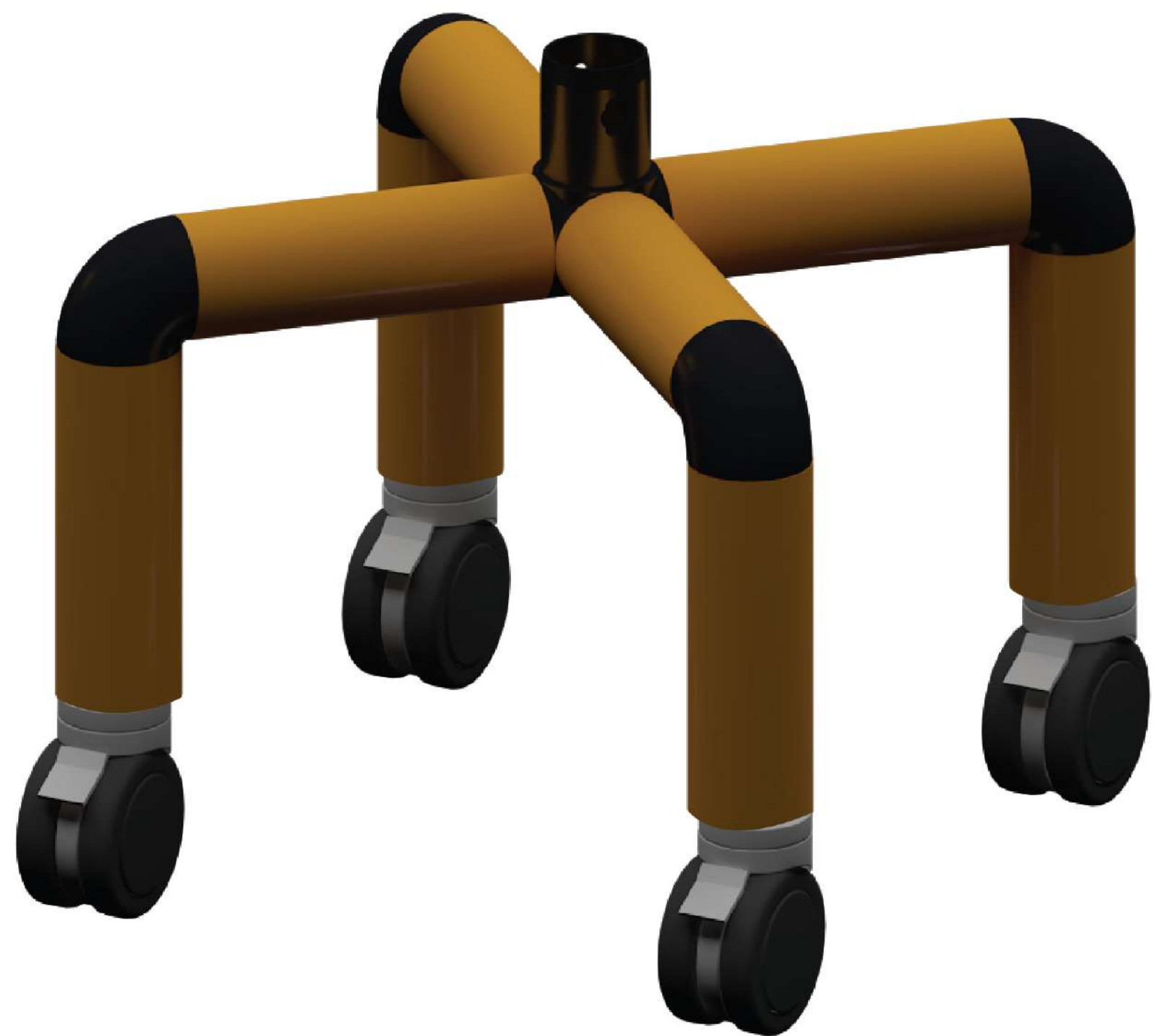

- Put the tube of the assembled wheel over the connector, and secure with a screw.
- Do not build structures more than 1-1.5 levels high. Always make sure to add the correct number of wheels to make it a balanced wheeled structure (Preferably use all six wheels included with the set).

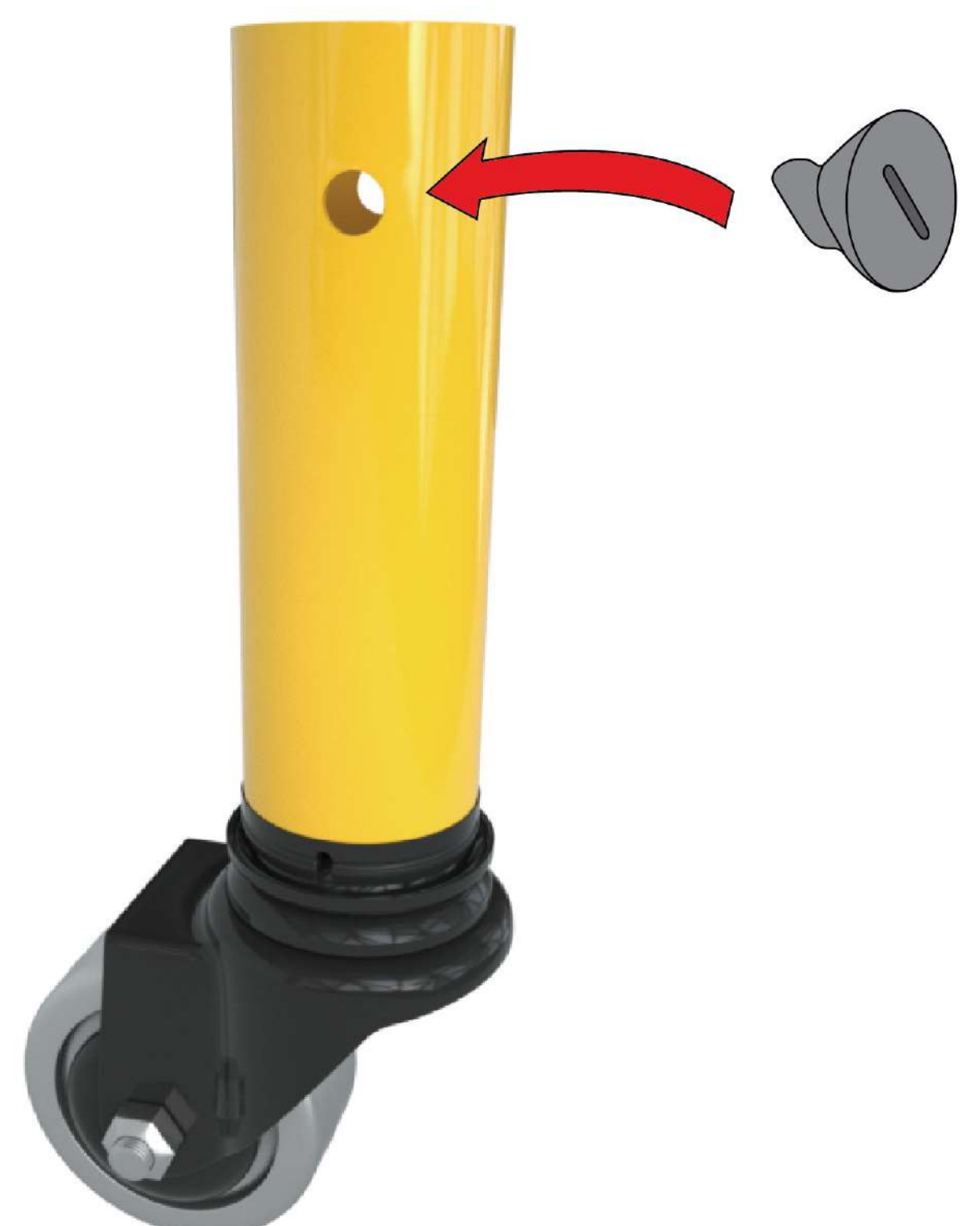



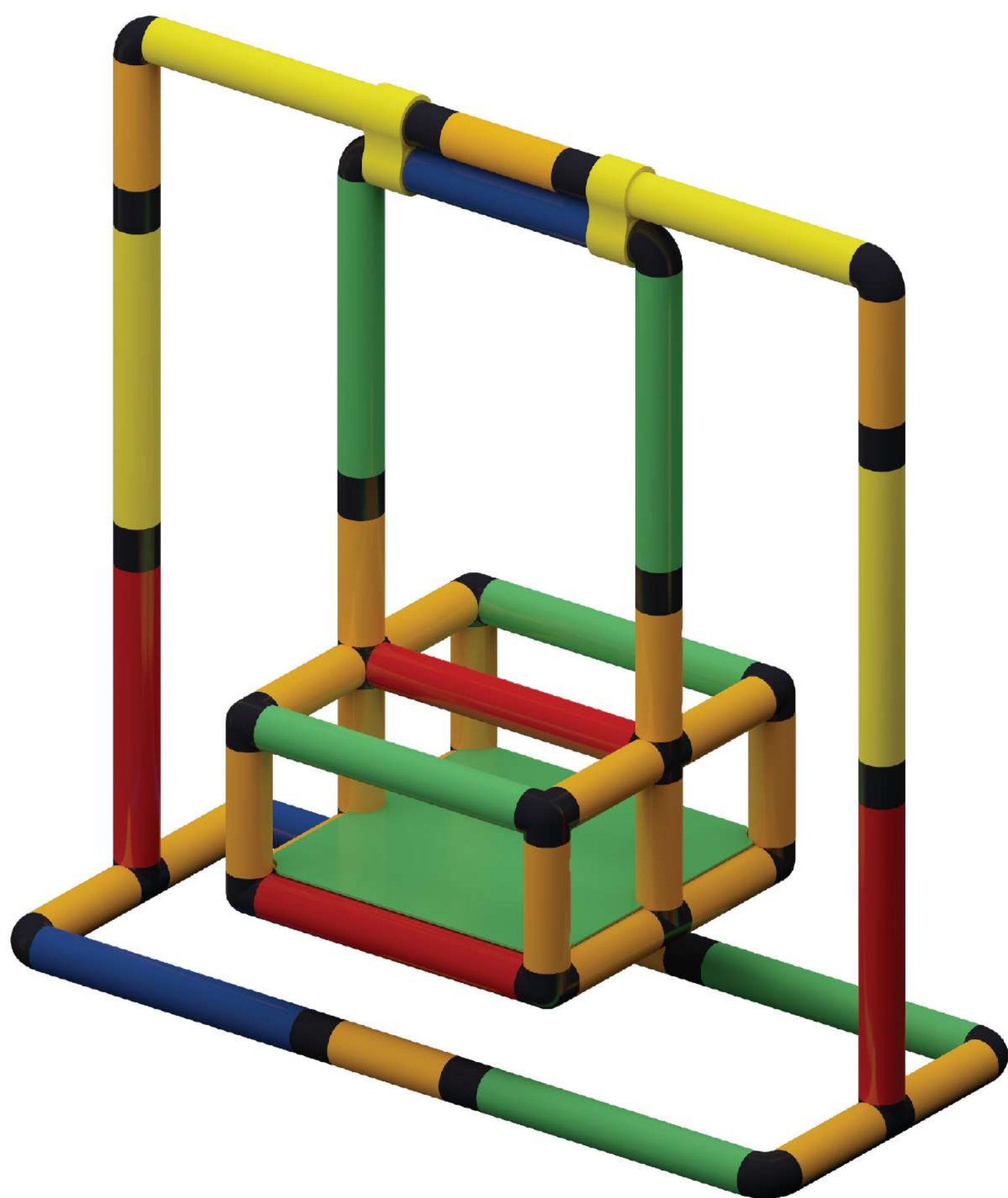

See images how to use the duplex connector

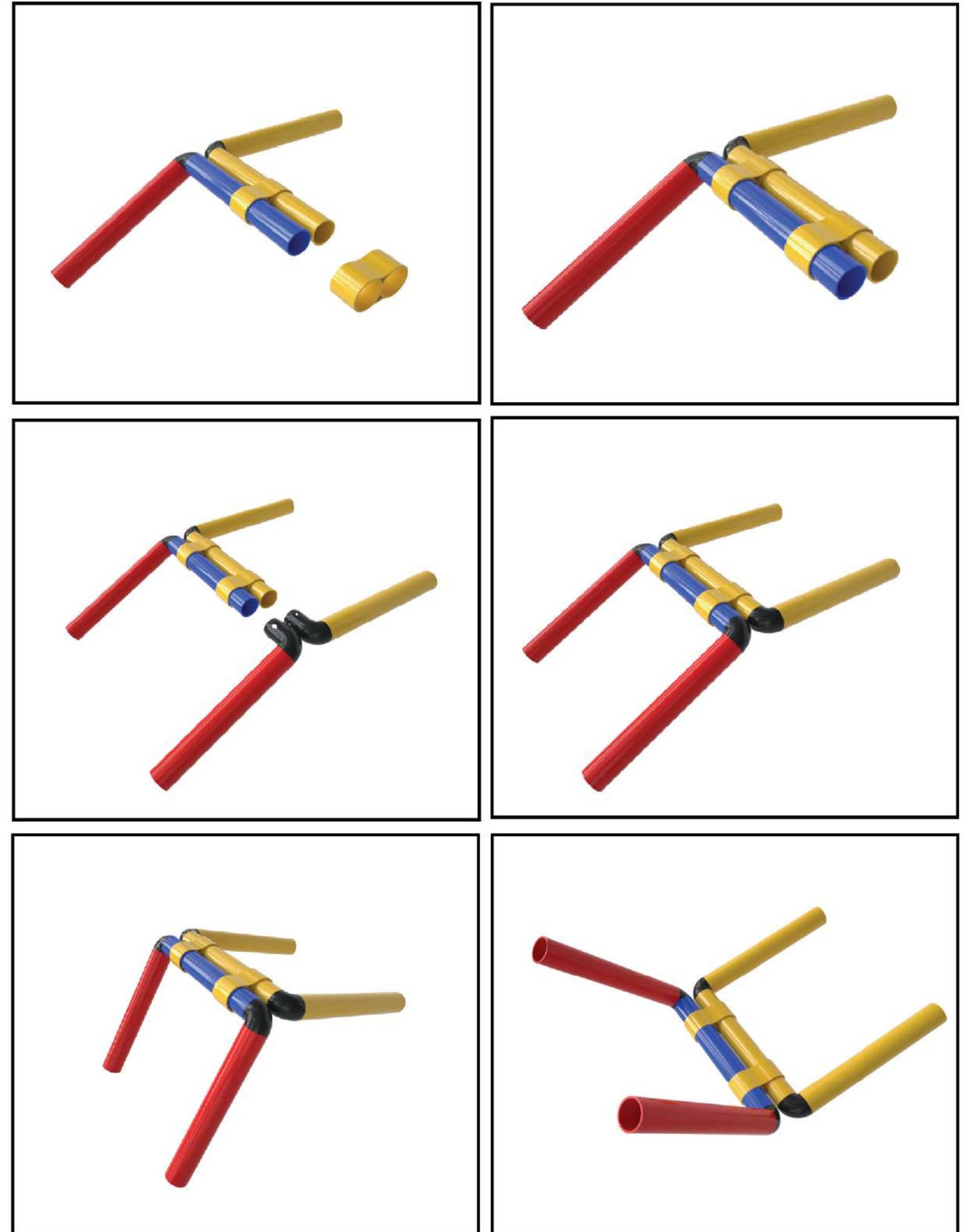

## Warranty

It is our ultimate goal to serve our happy customers.

## Funphix provides

5 Year warranty on Funphix parts when used indoors.

3 year warranty on Funphix parts when structures has been used or stored outdoors for greater than 3 months.

## Dear kids,

The team at funphix is excited to see you creating your own play structures. Send us a picture or video of your play structure which you self-designed or built from the manual.

We will consider posting it on our gallery. Send the image to [mystructure@funphix.com](mailto:mystructure@funphix.com)

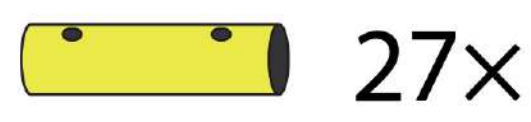
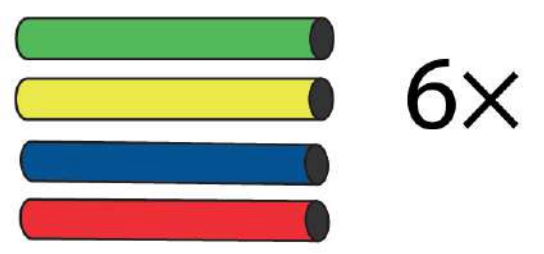
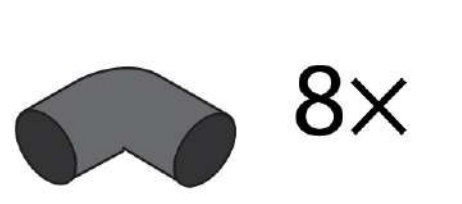
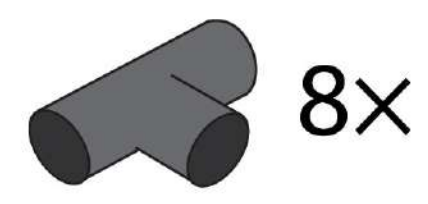
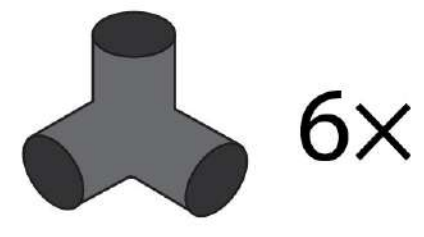
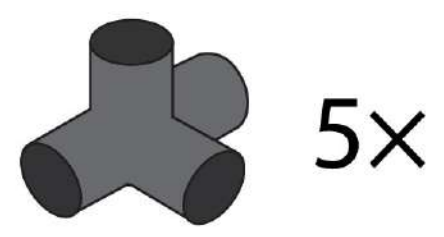
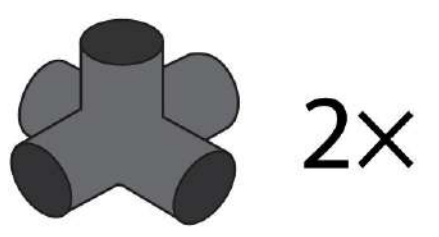

# Double Baby Stroller

1



2



3

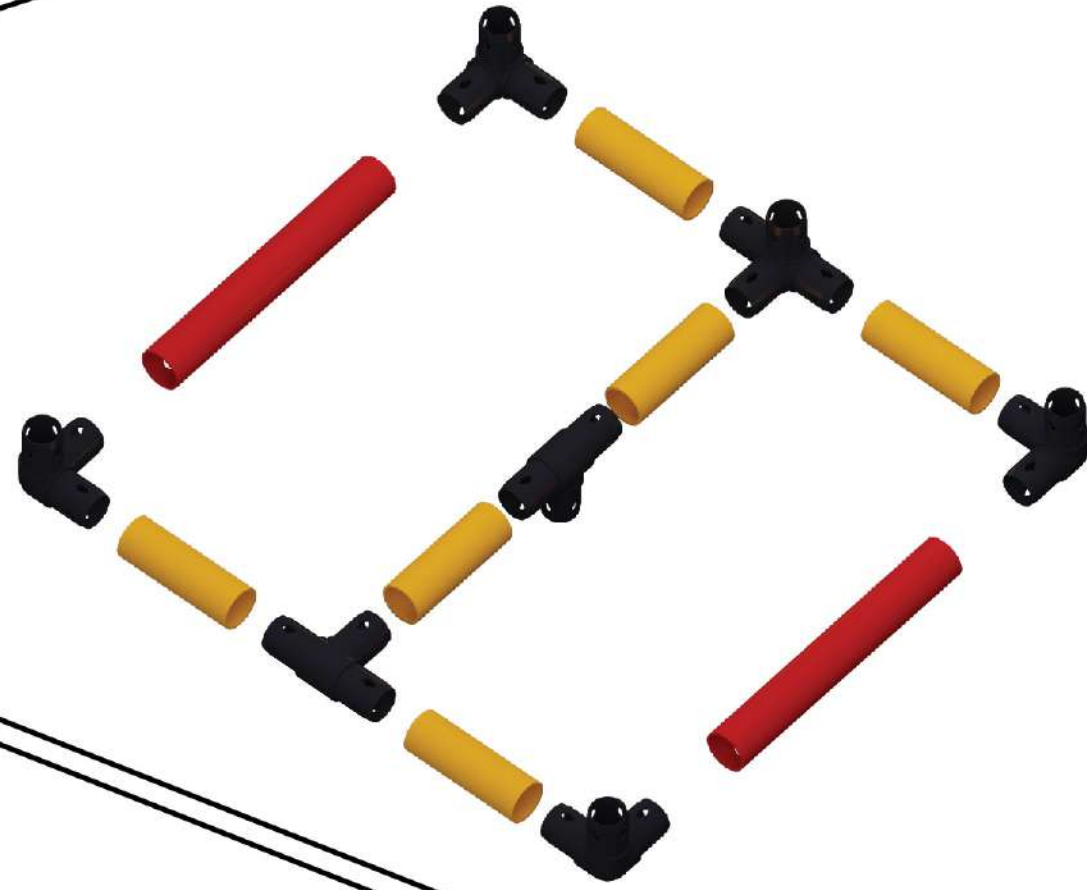

4

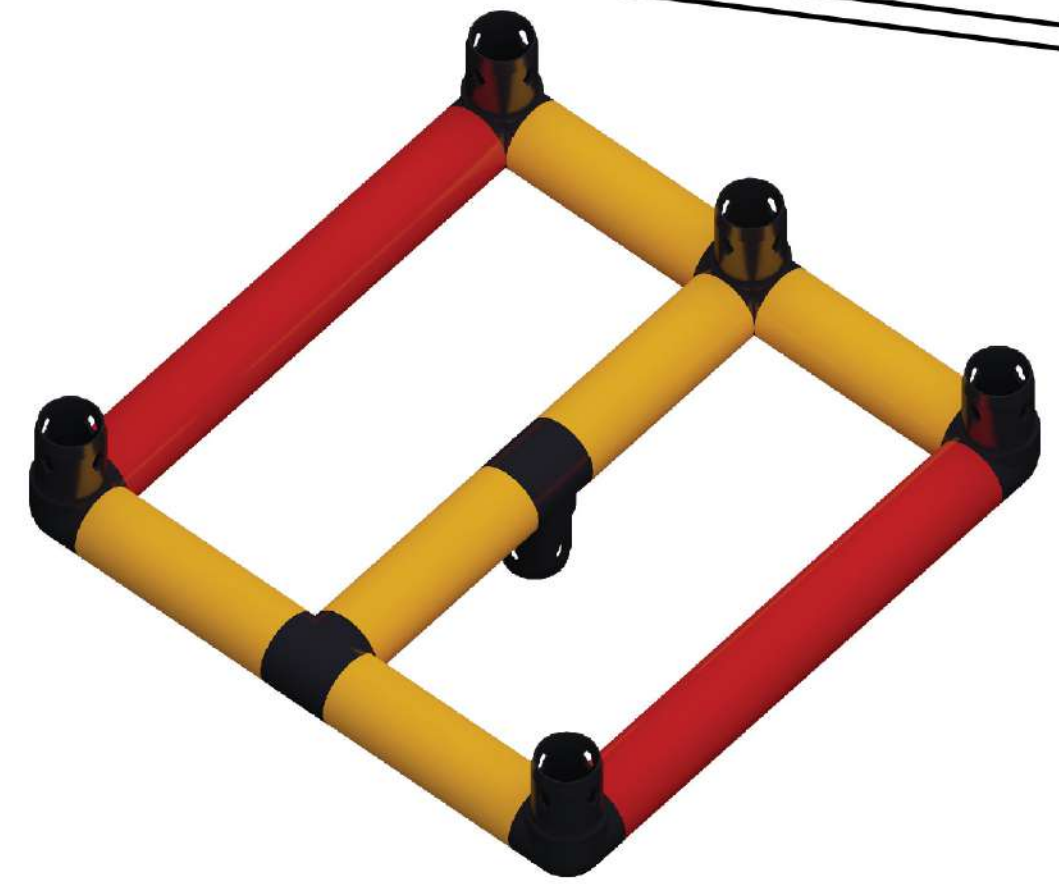

5



6



8

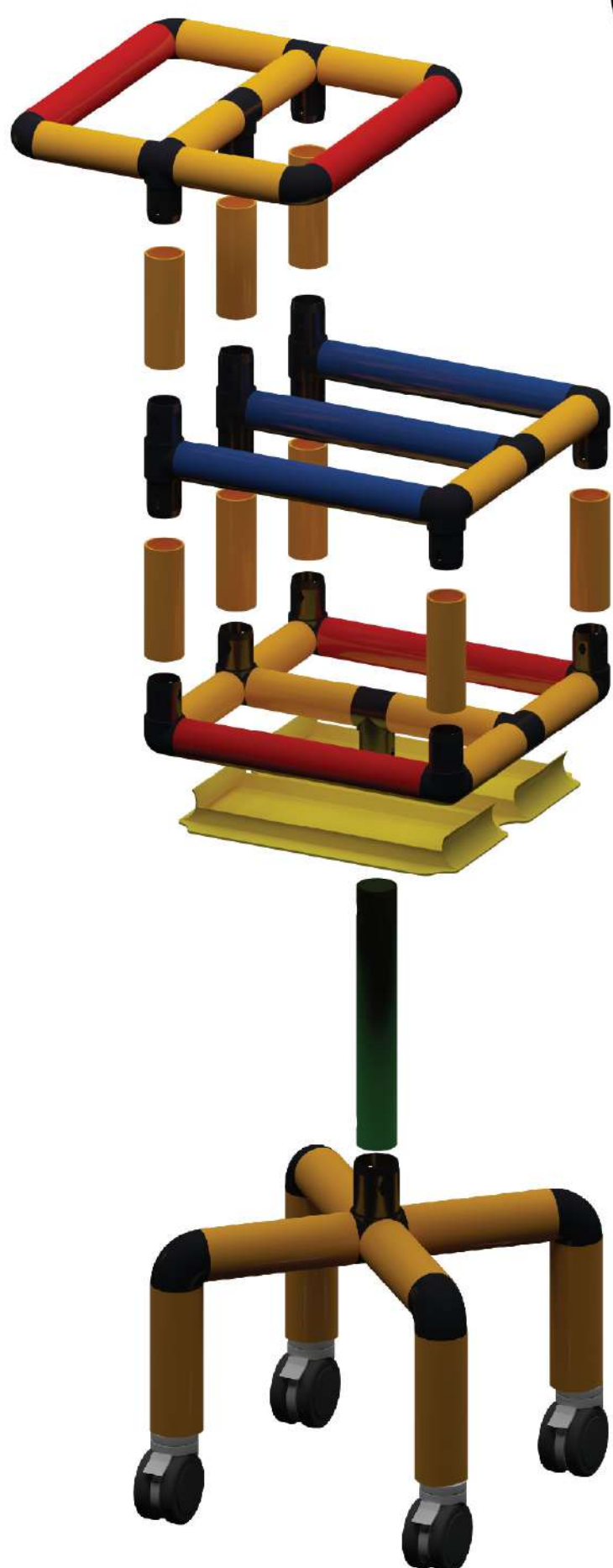

7



9

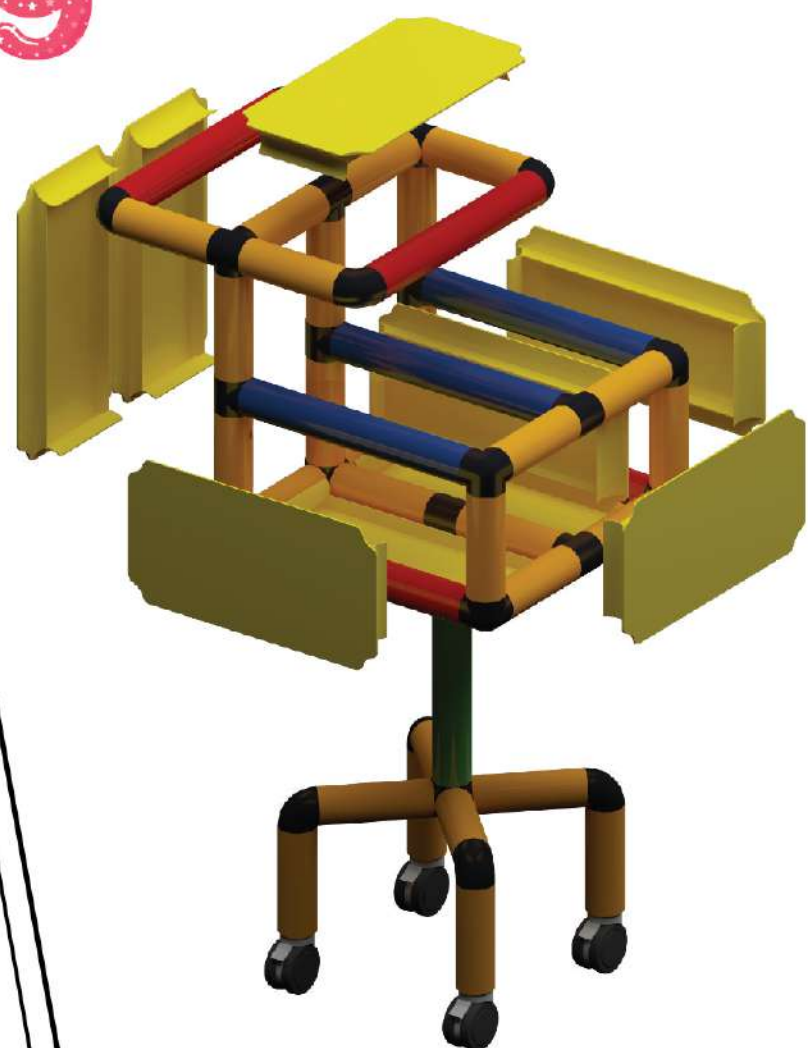

10



Insert Screws and Panels and Secure all Screws

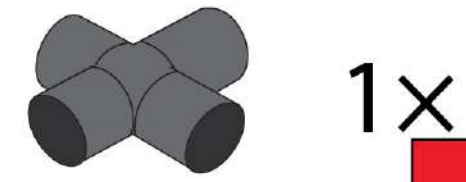
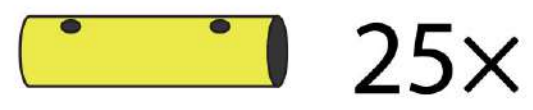
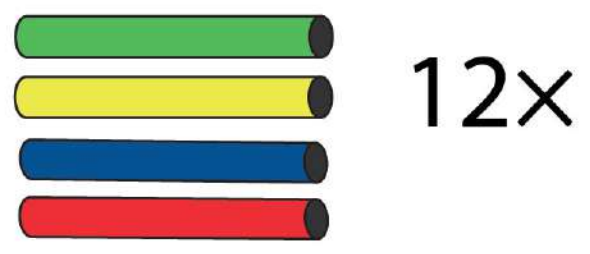
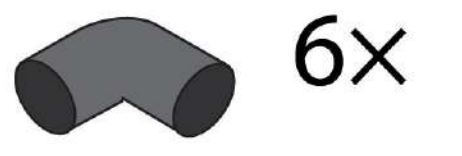
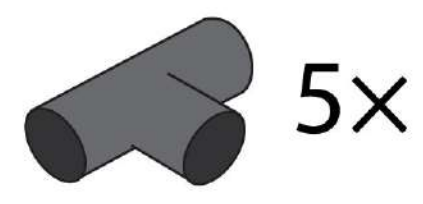
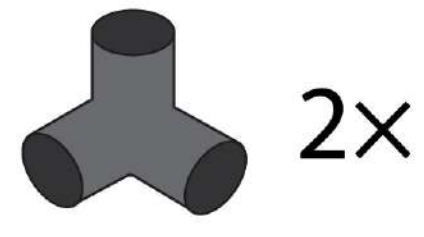
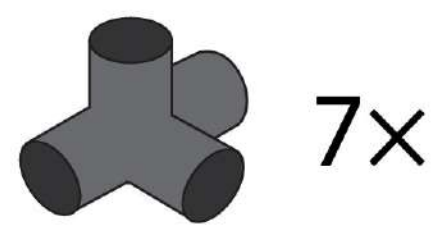
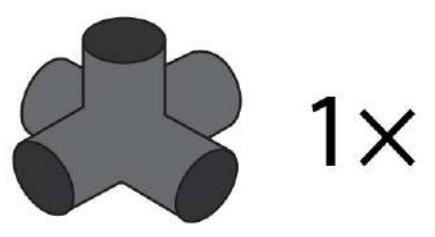

# Twin Doll Bench

1

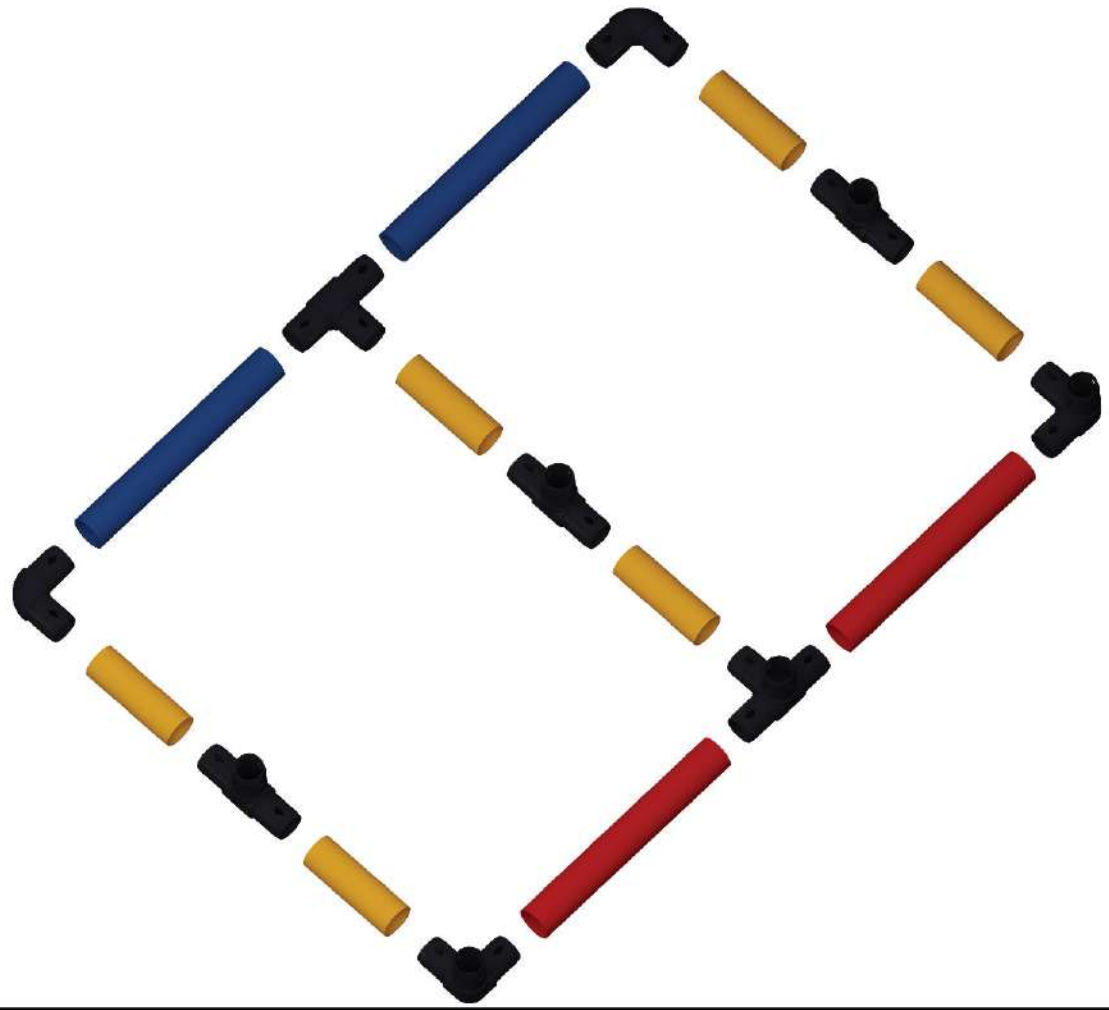

2

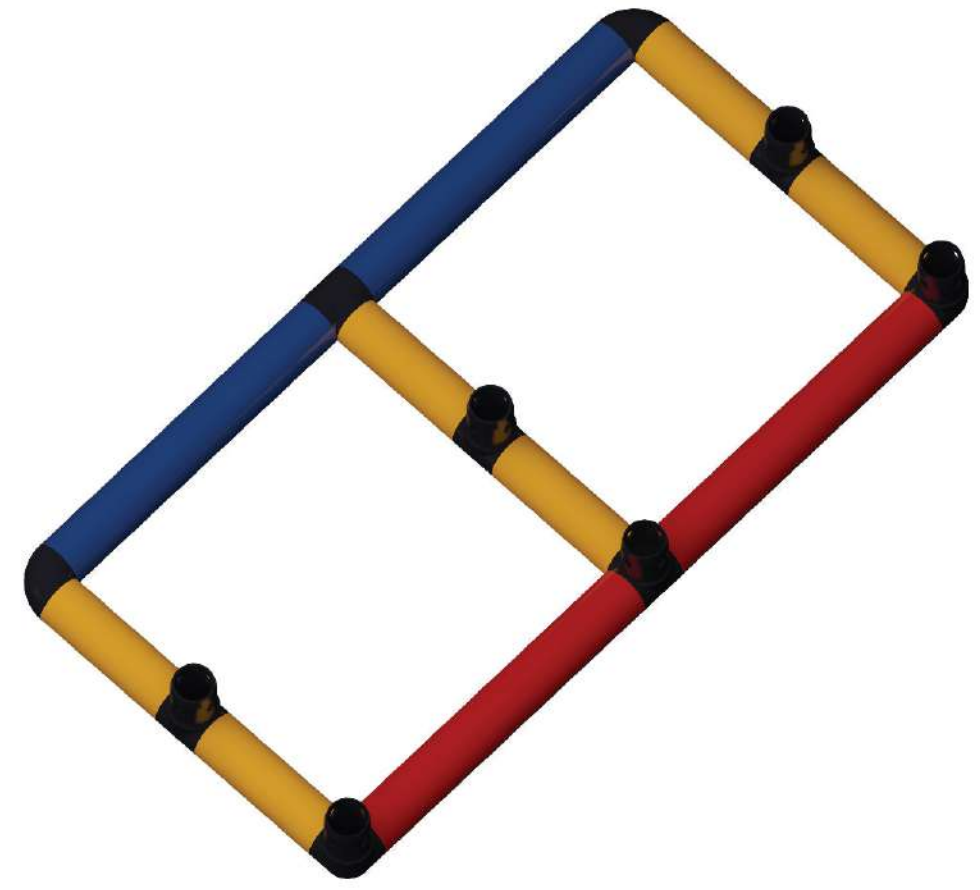

3



5



4

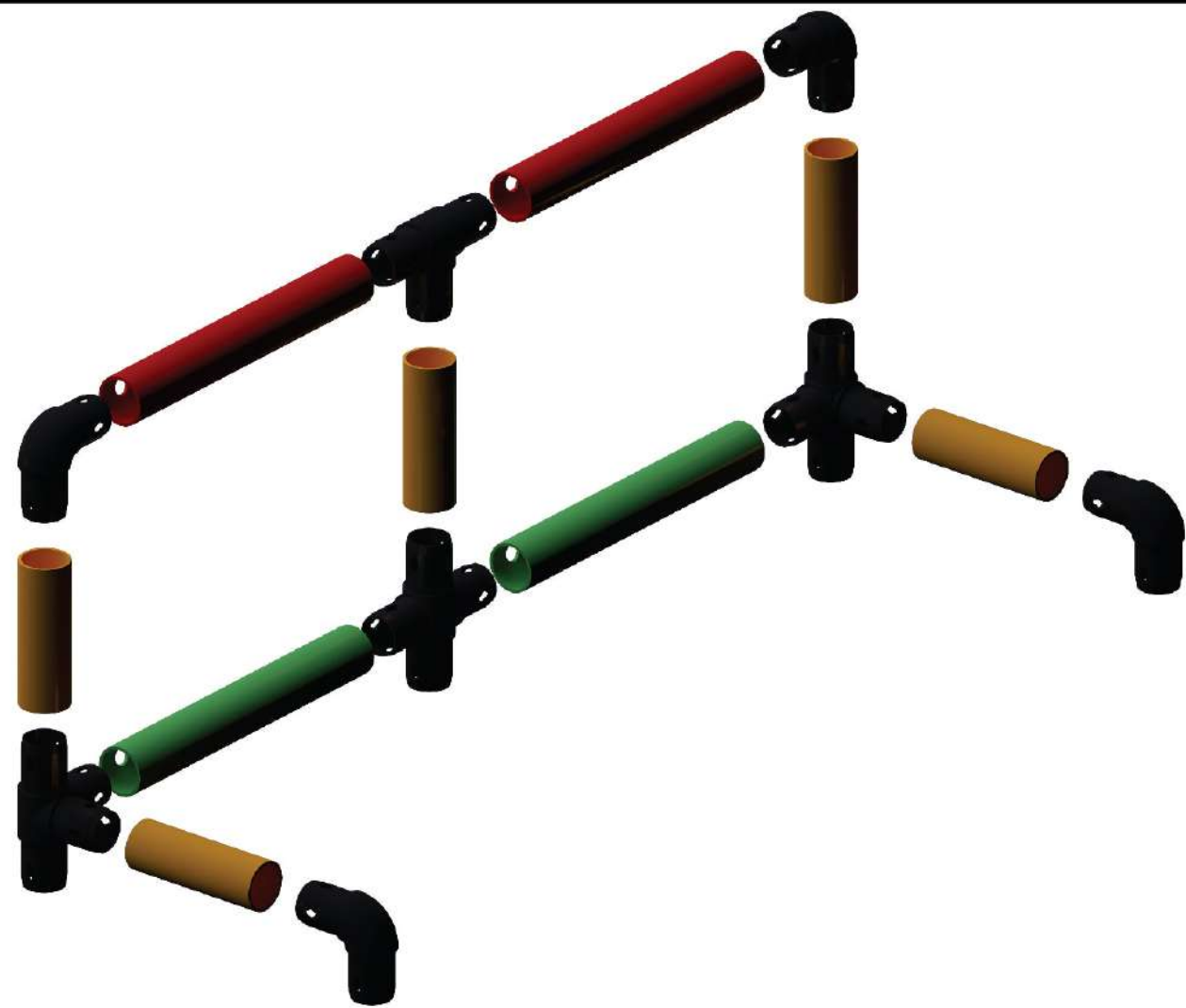

6

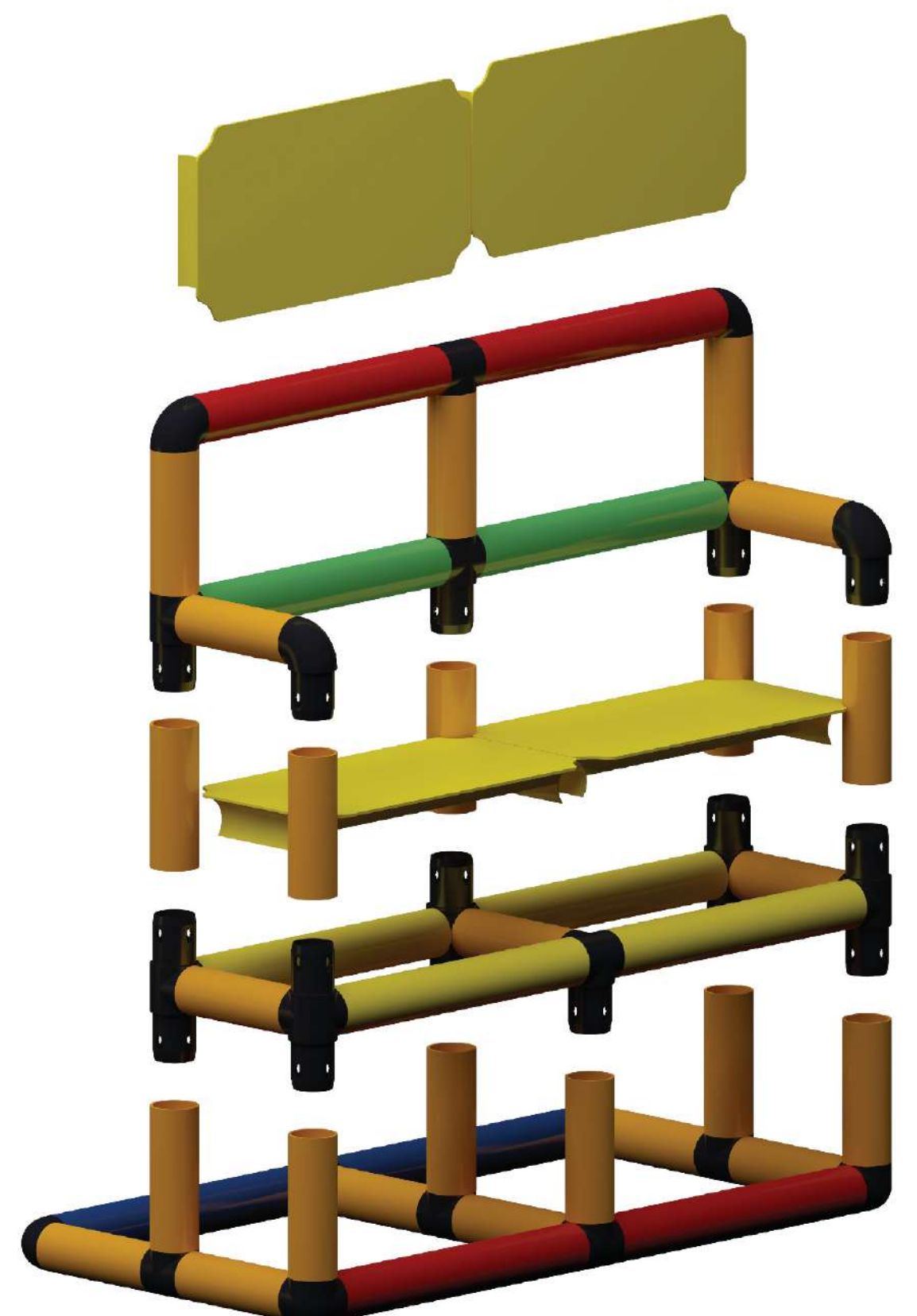

7

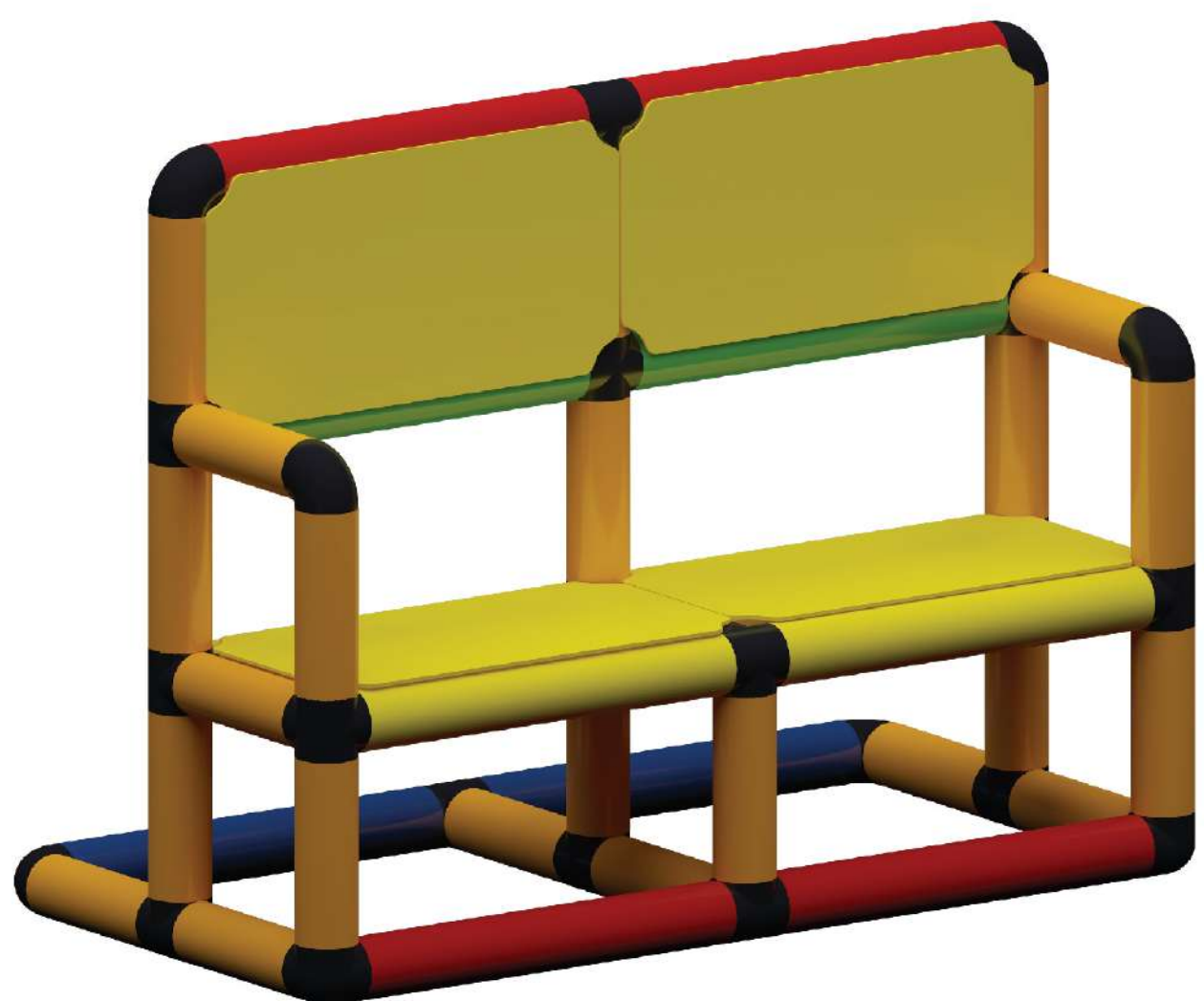

Insert Screws and Panels and Secure all Screws

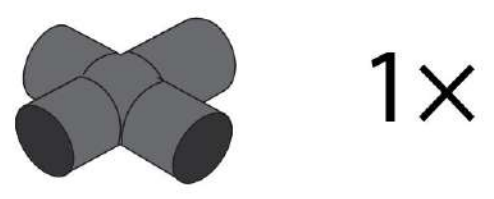

1x

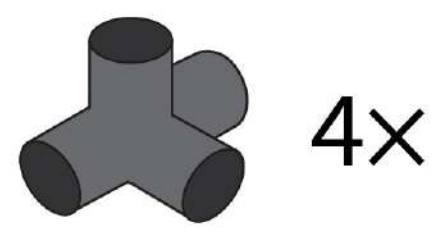

4x

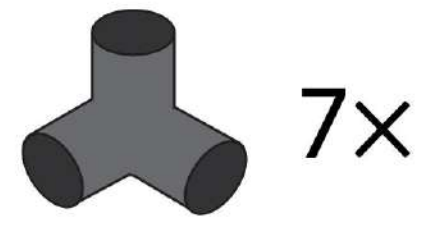

7x

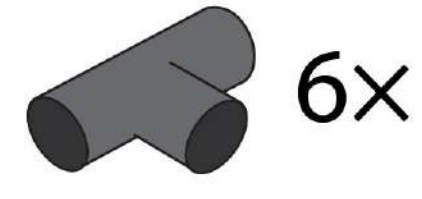

6x

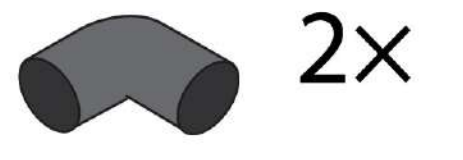

2x

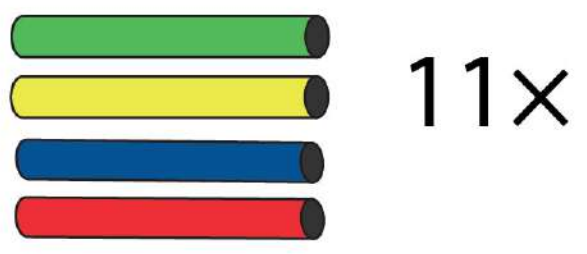

11x

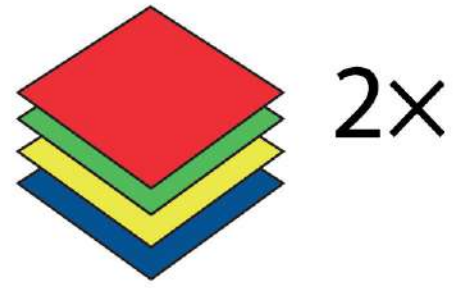

2x



2x

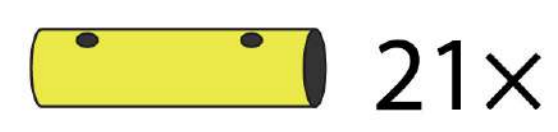

21x

# Twin Doll Swing

1



2

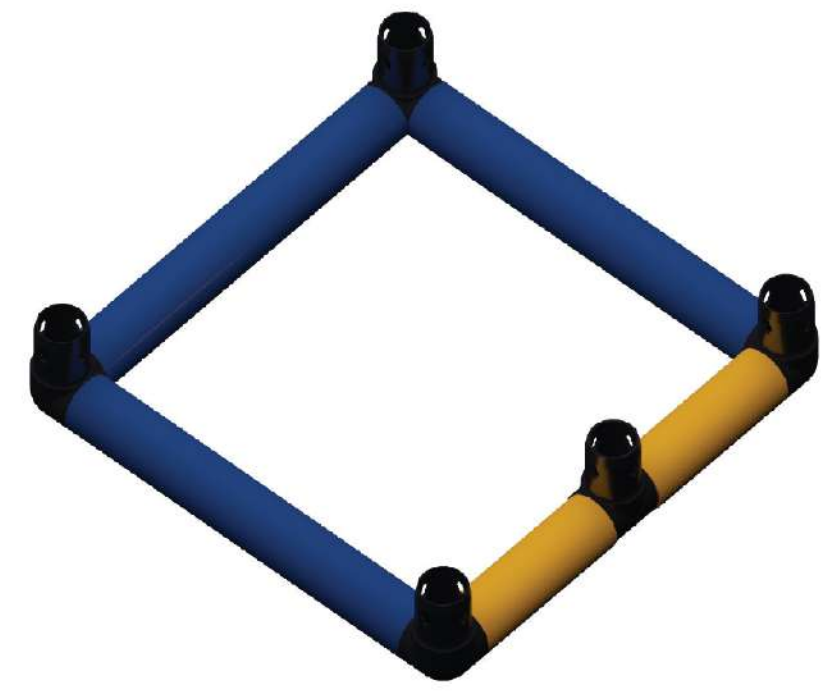

3



4



5

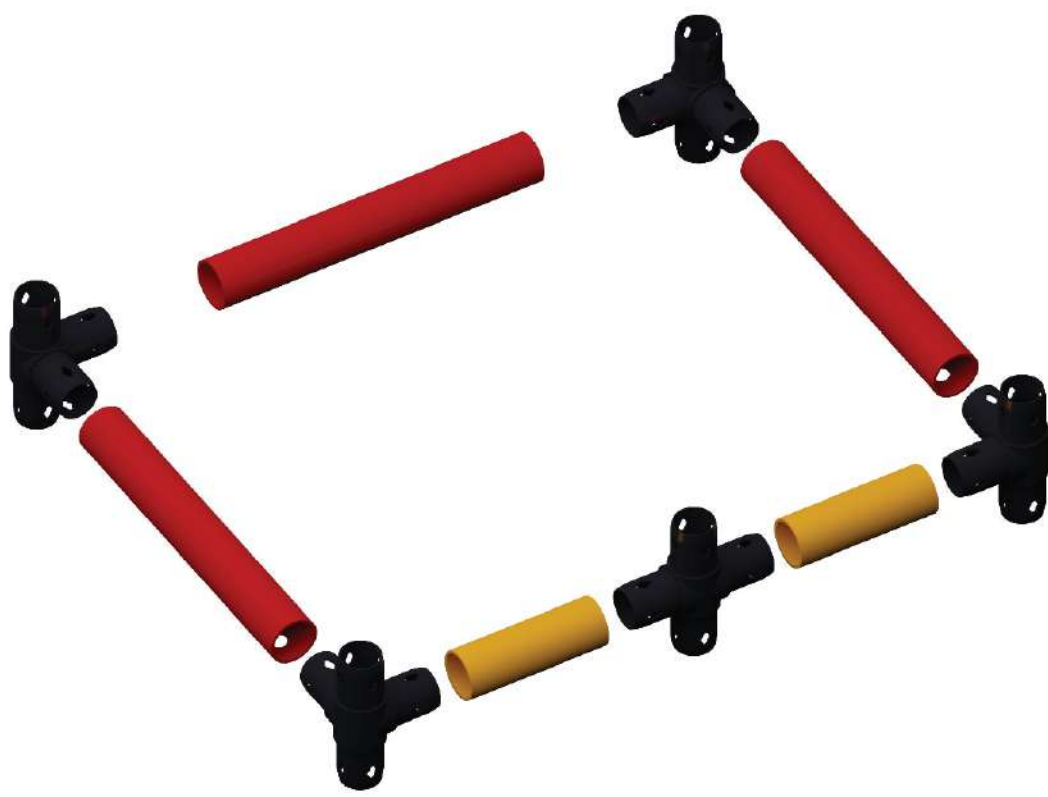

6



7



8

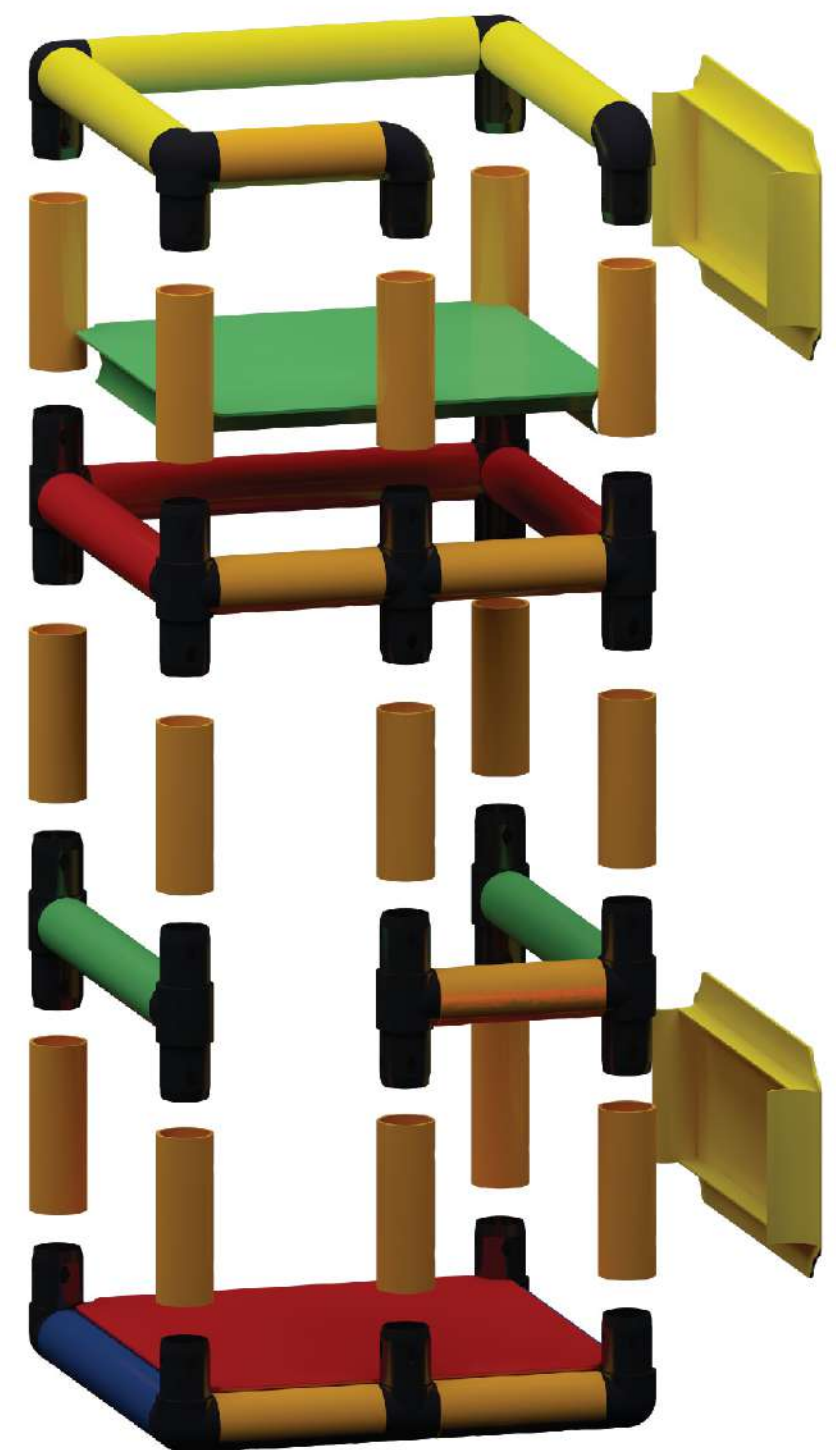

9



Insert Screws and Panels and Secure all Screws

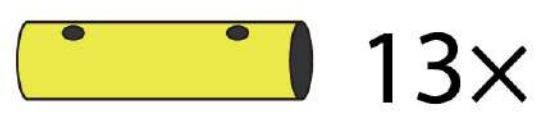
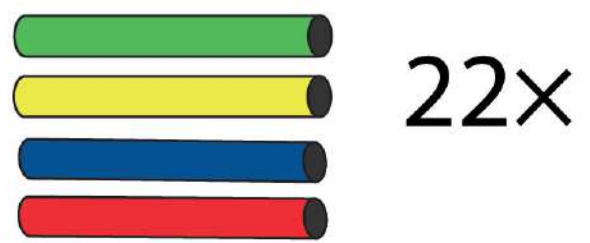
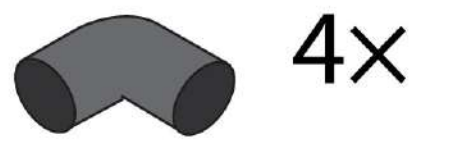
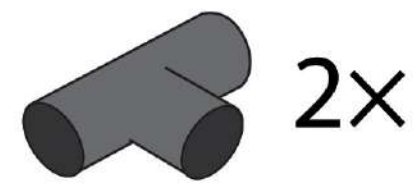
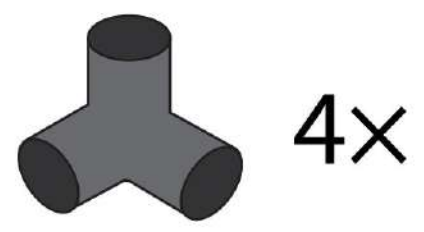
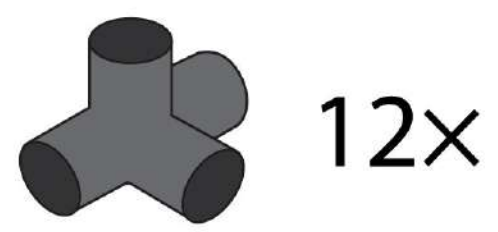
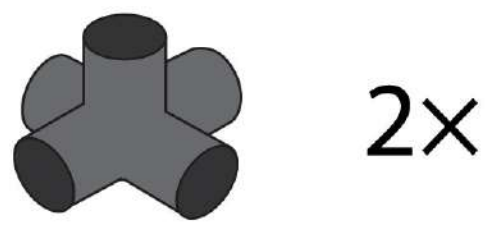

# High Chair

1



2



3

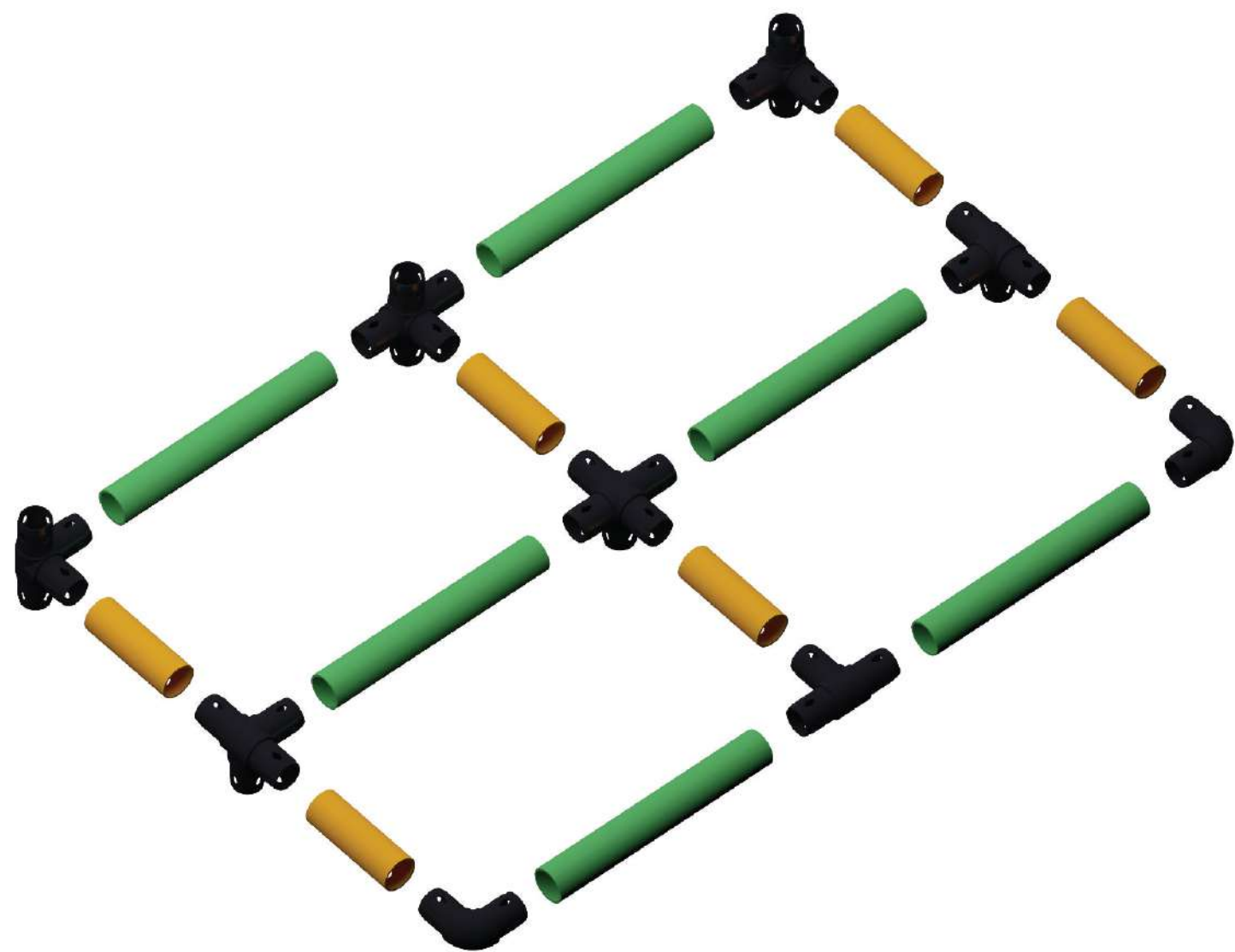

4

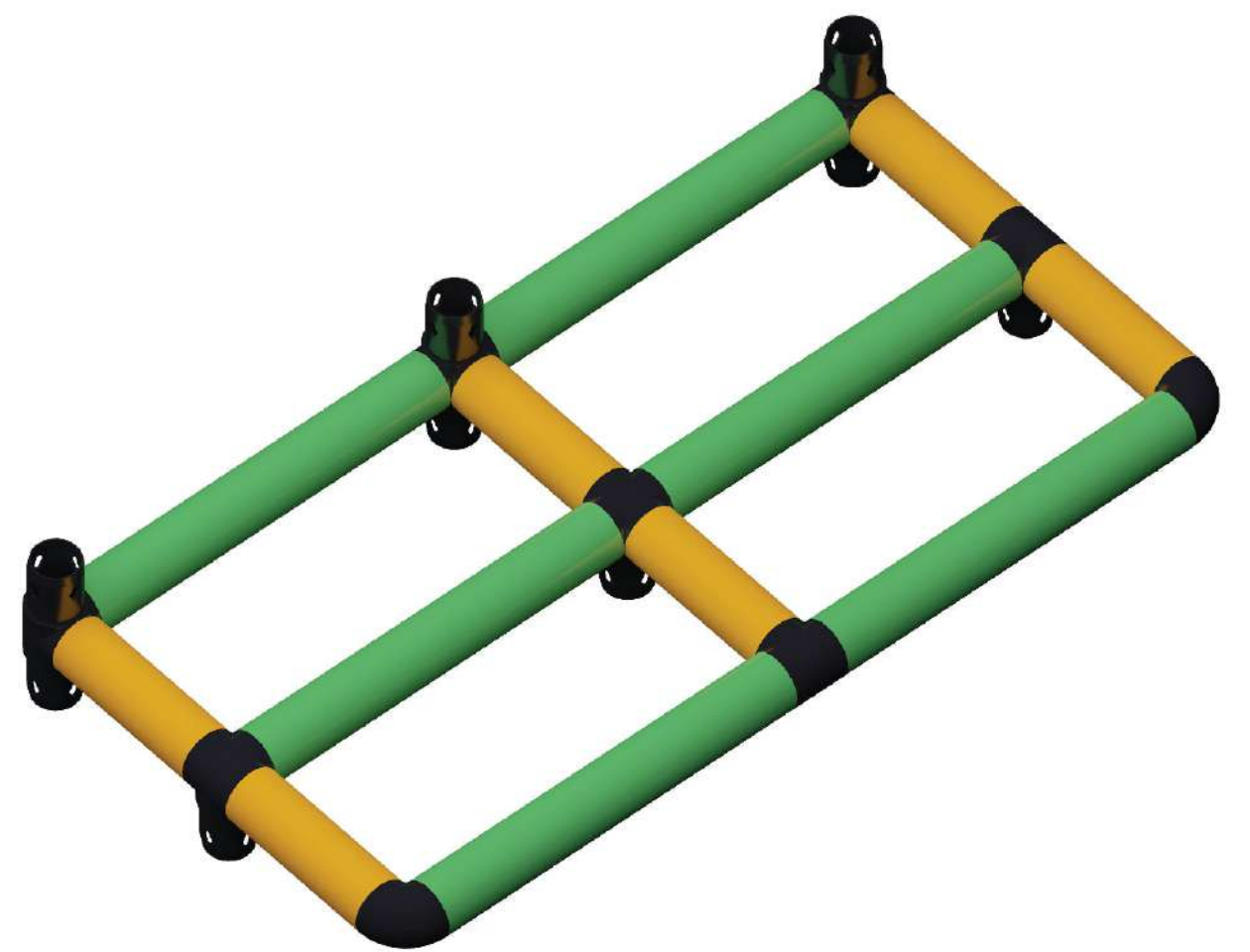

5



6

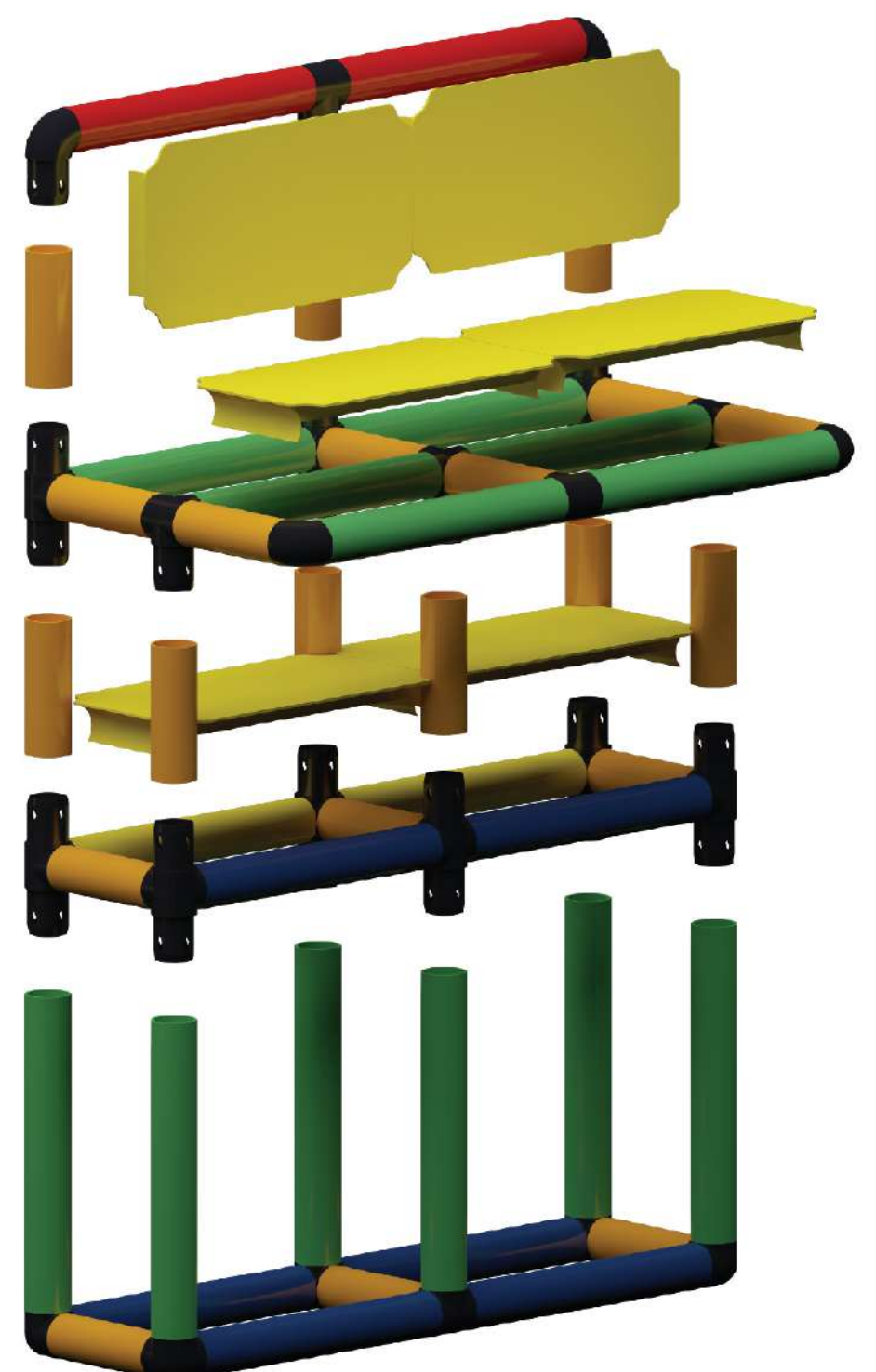

7

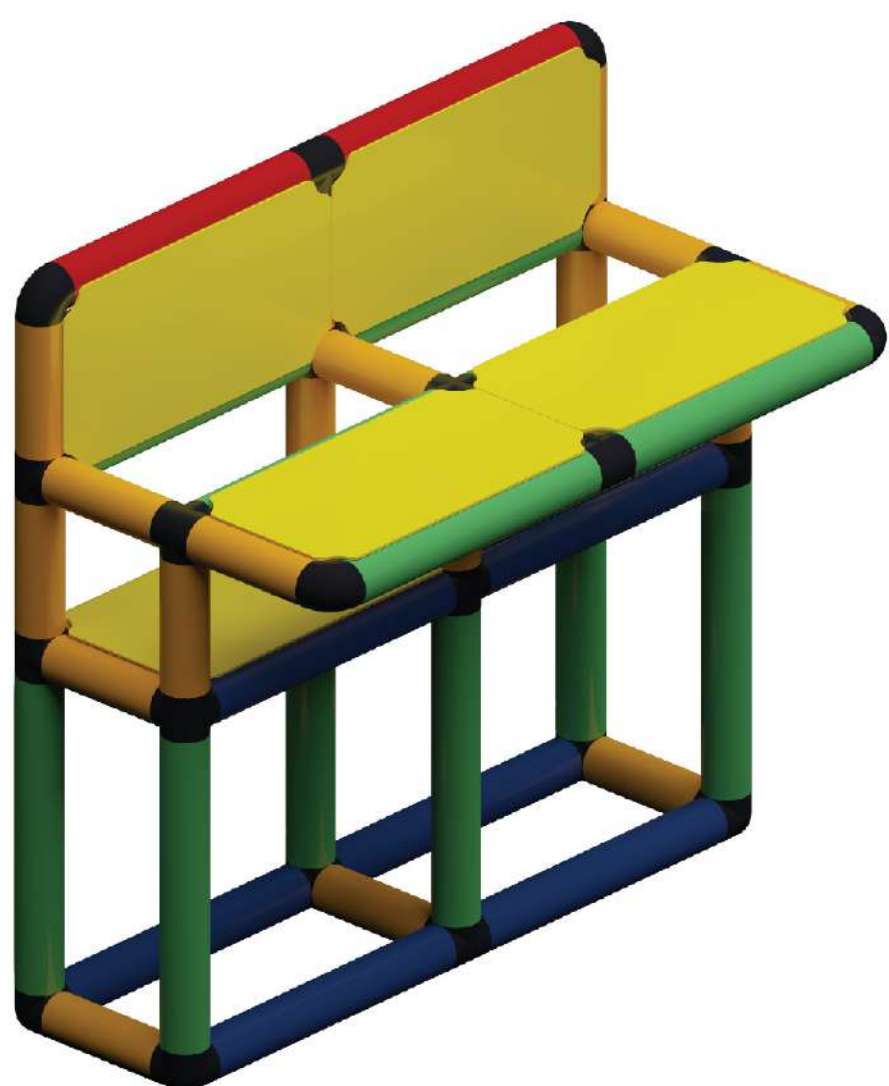

Insert Screws and Panels and Secure all Screws

16x

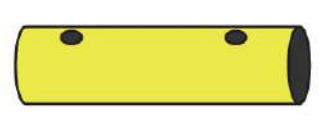

4x

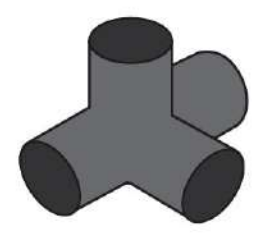

4x

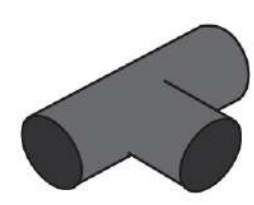

4x

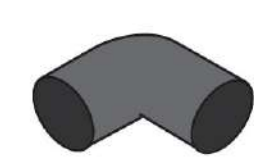

5x



4x

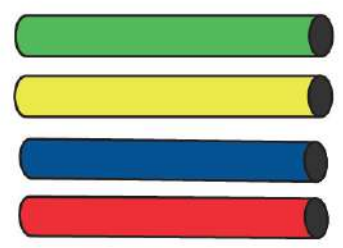

# Single Bed

1

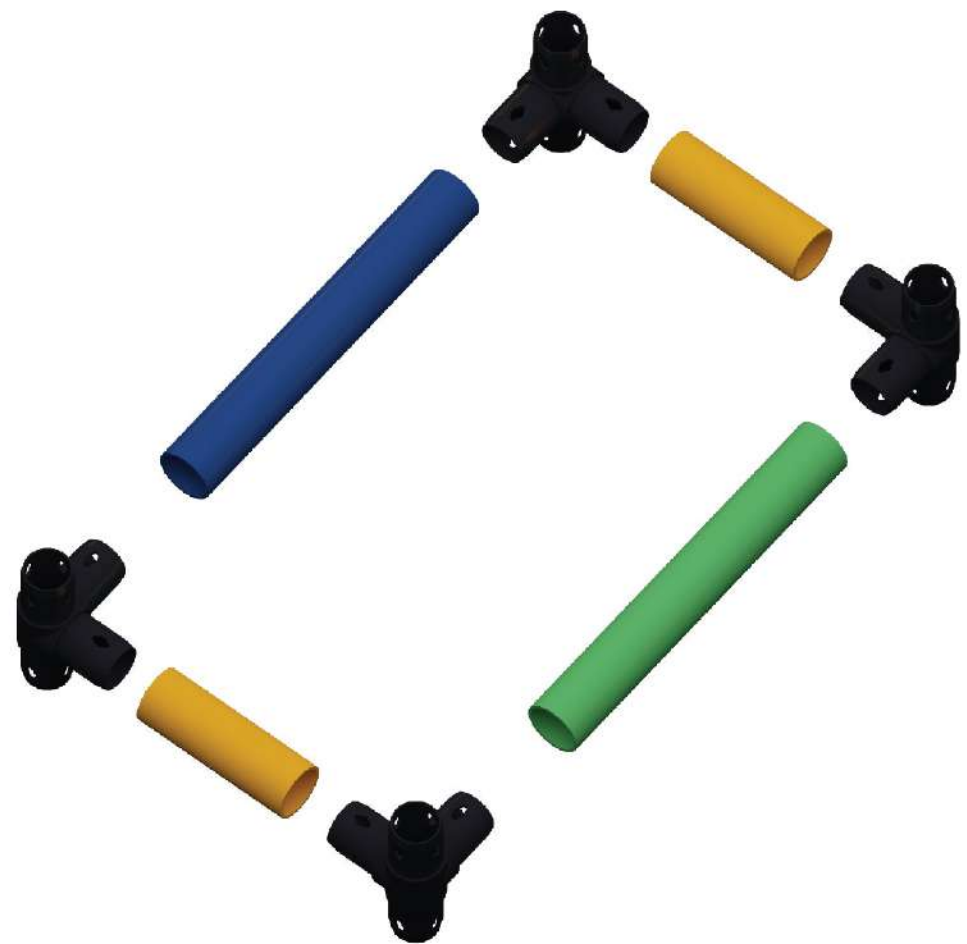

2



3



4



5



6



7

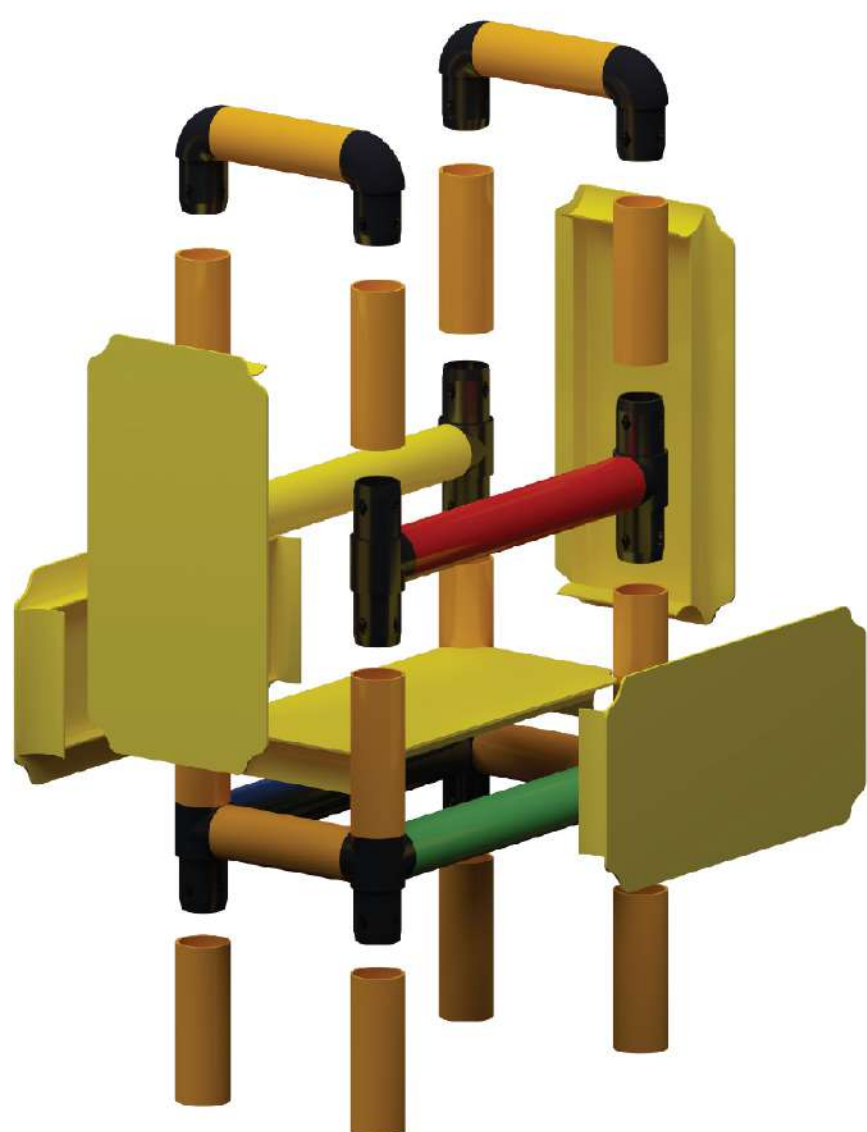

8



25x



2x

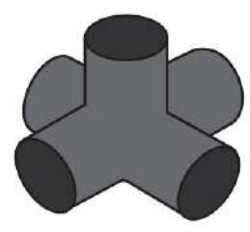

8x

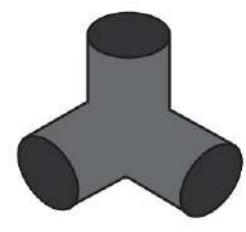

28x

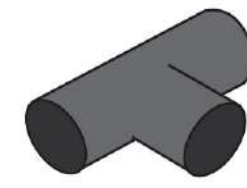

2x



18x

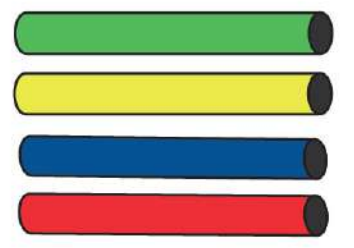

1x

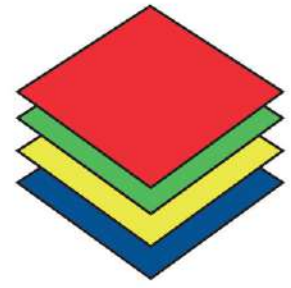

12x

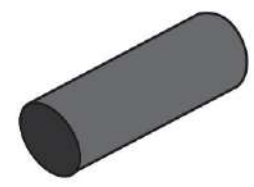

8x

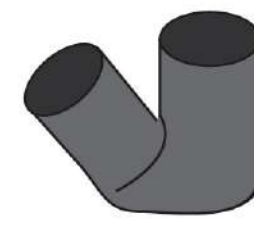

Swing

1



2

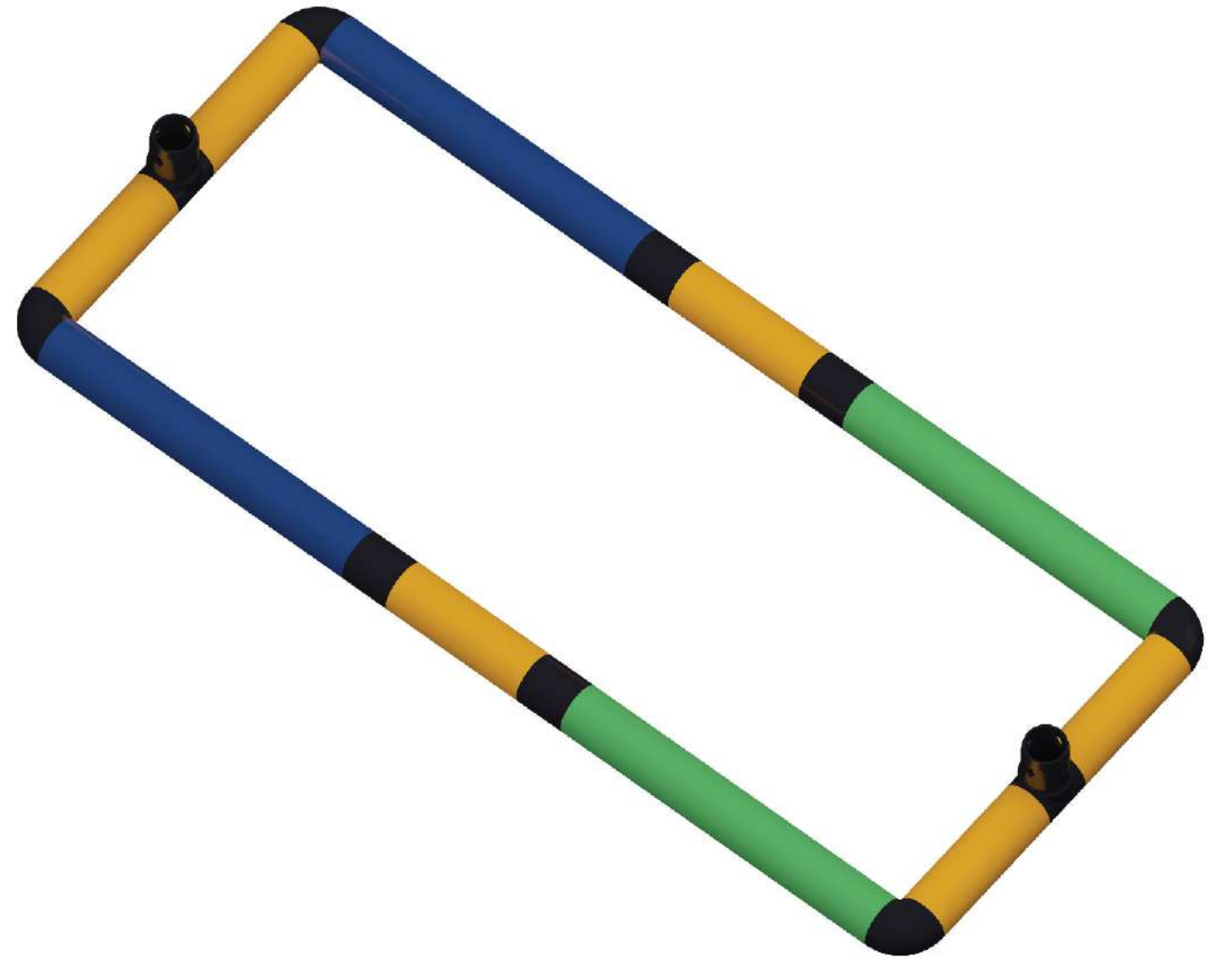

3

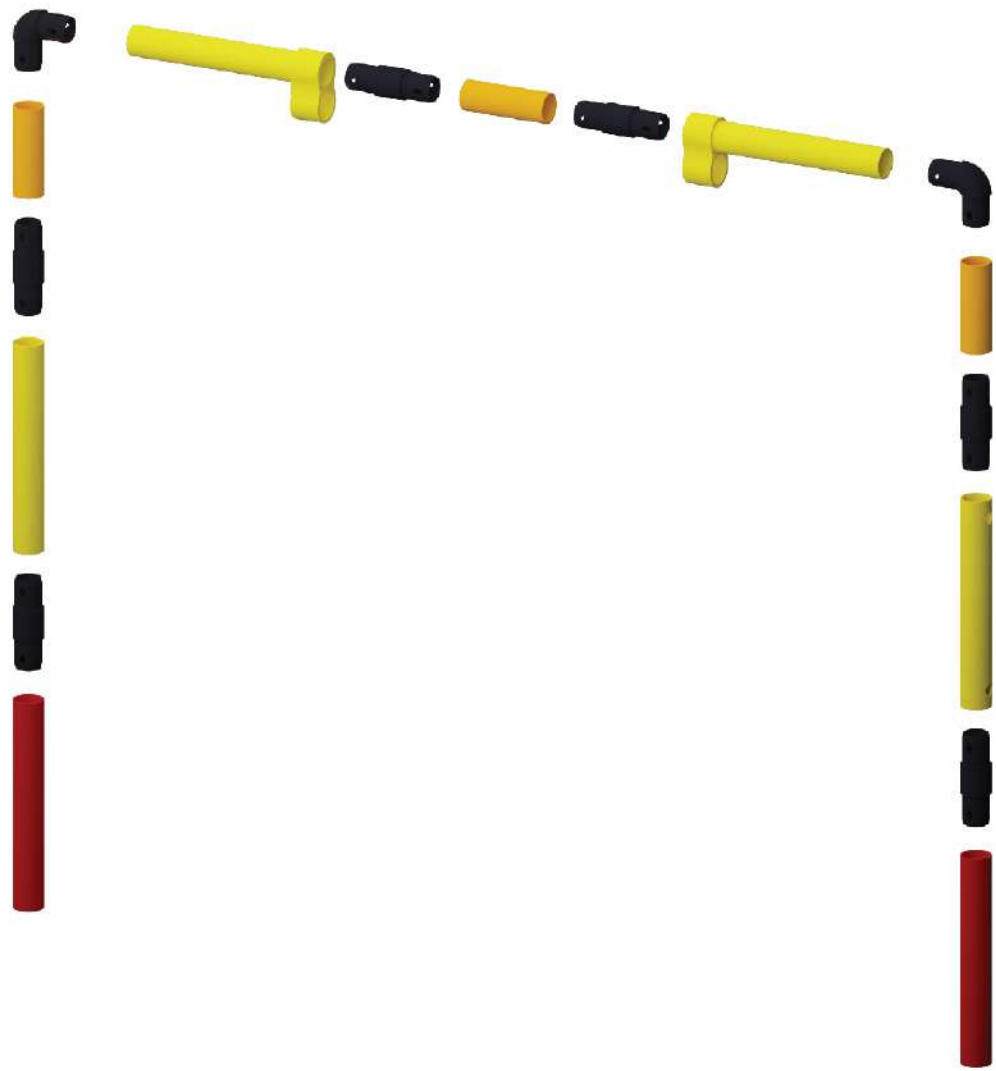

4



5



6



7

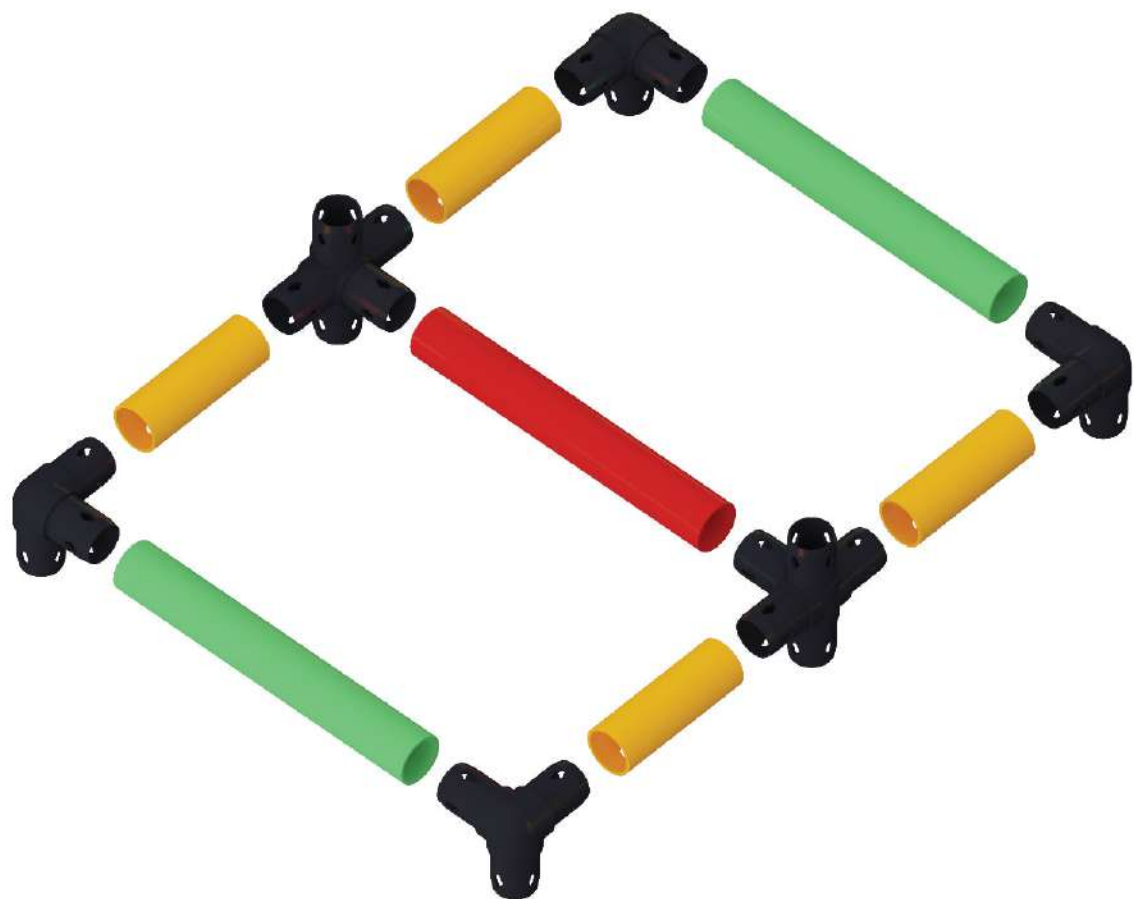

8

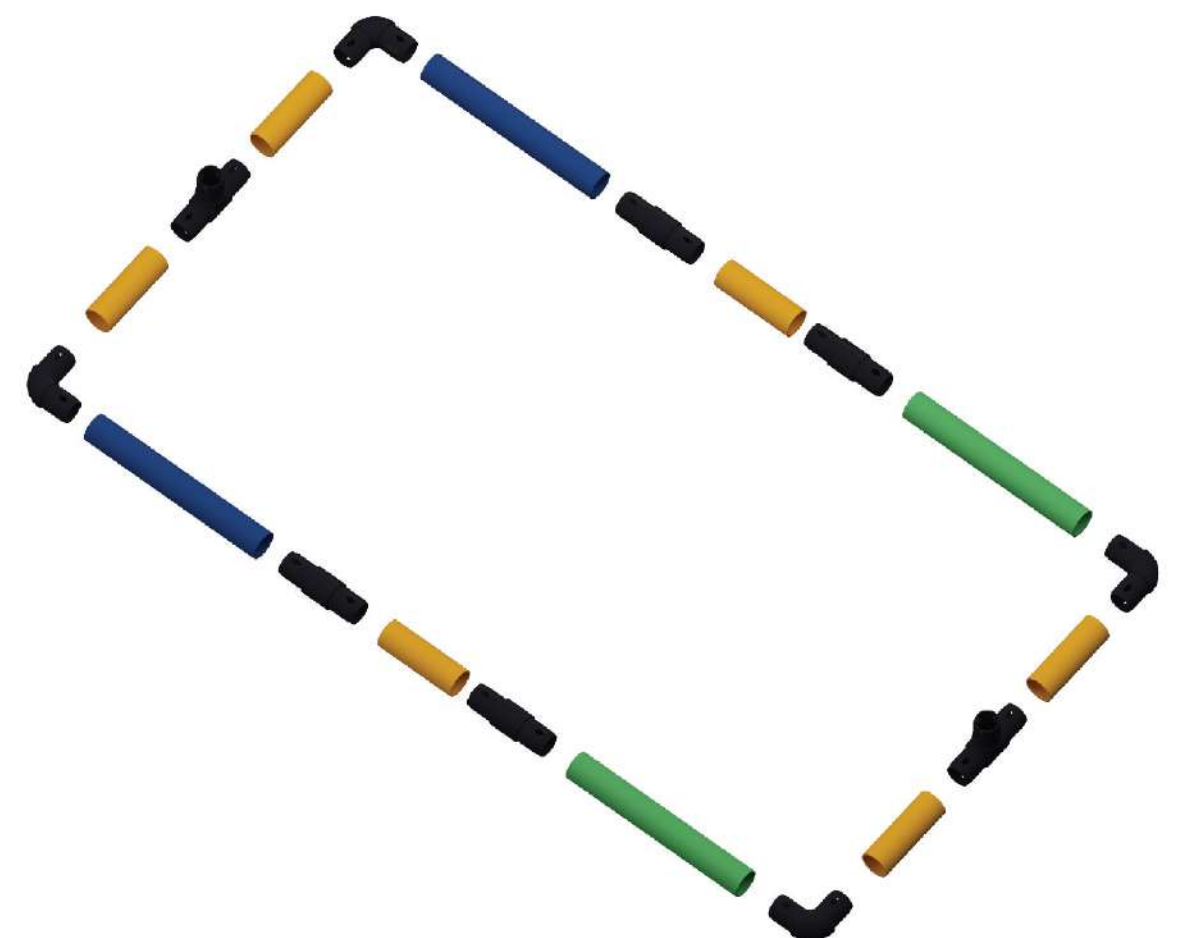

25x



2x

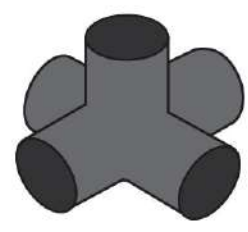

8x

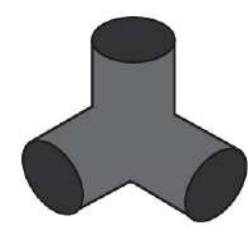

28x

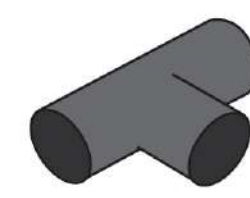

2x



18x



1x



12x

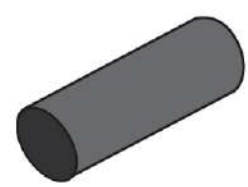

8x

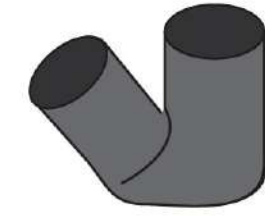

Swing

9

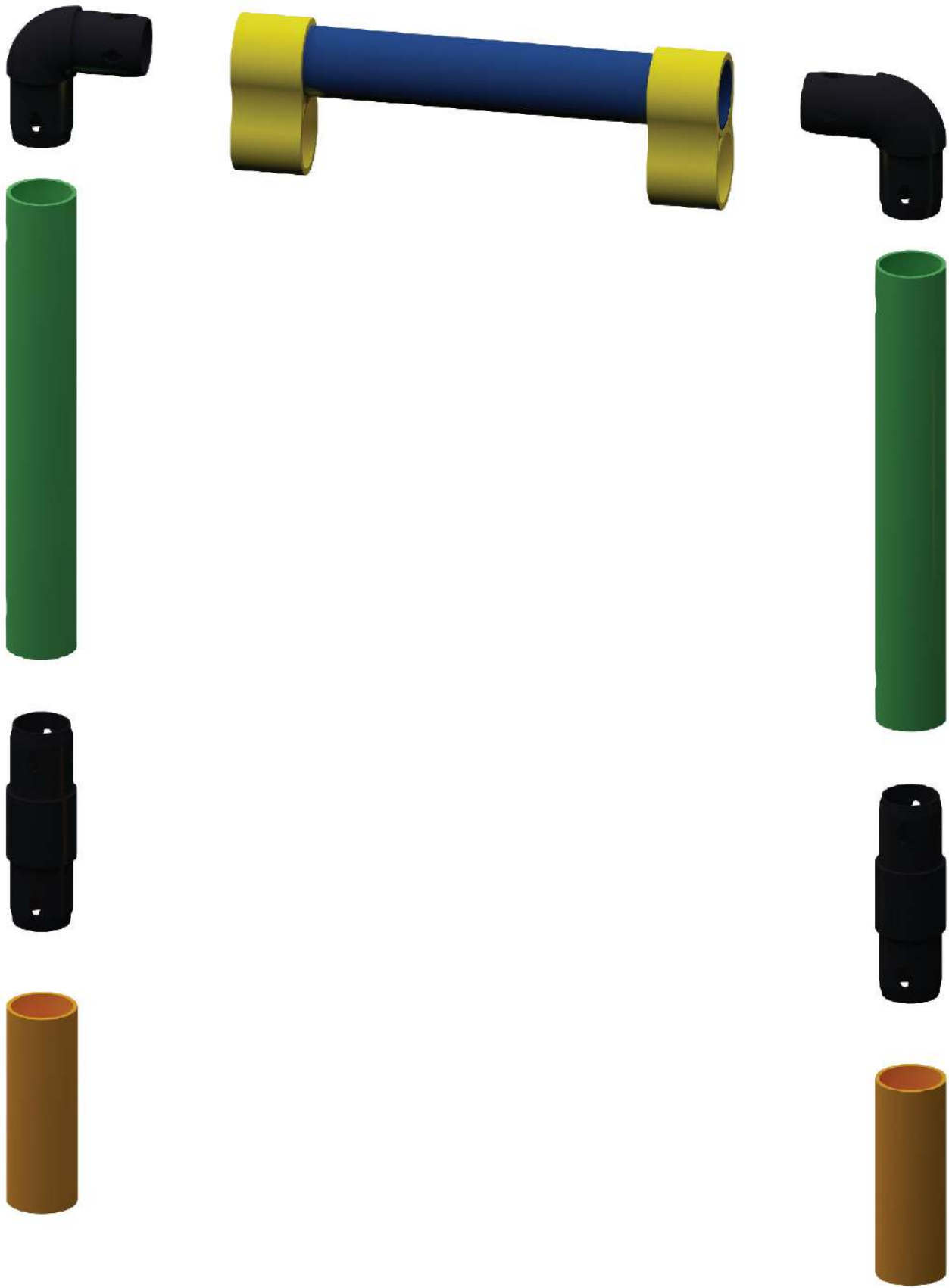

10

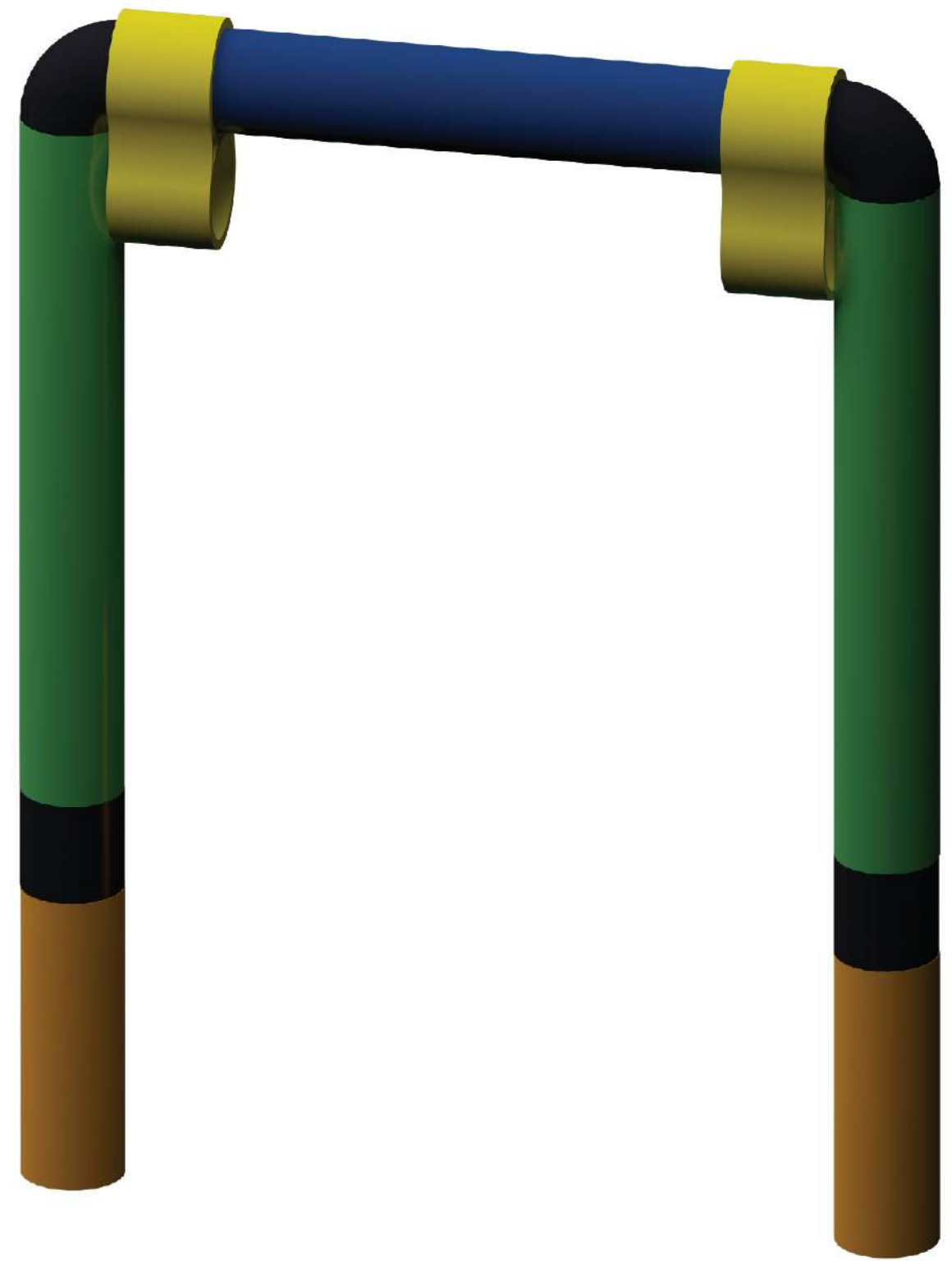

11



12

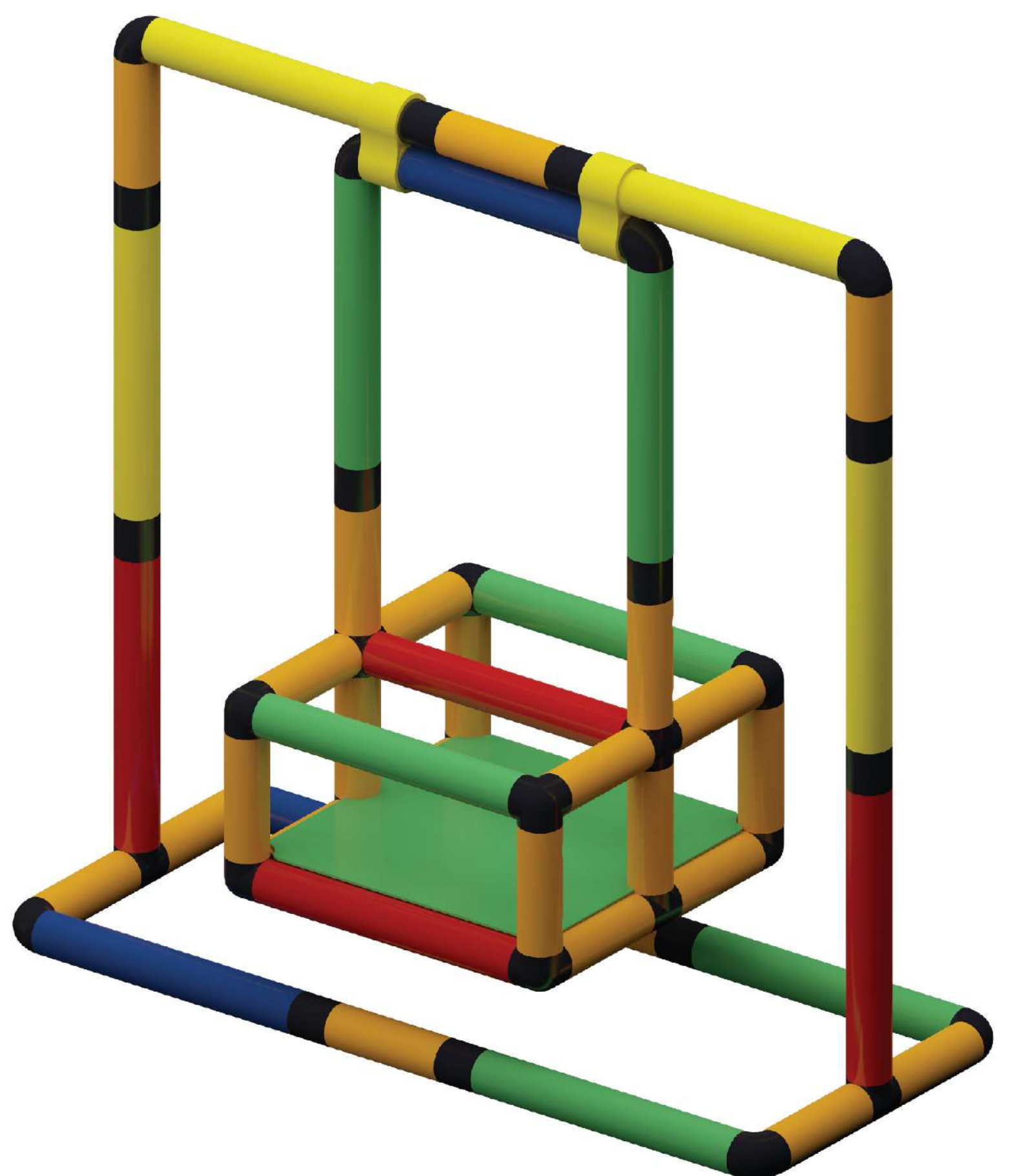

Insert Screws and Panels  
and Secure all Screws



22x



4x

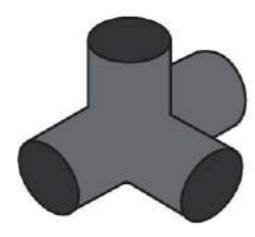

8x

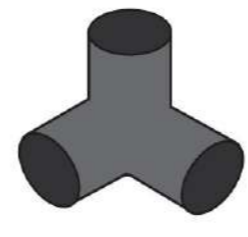

4x

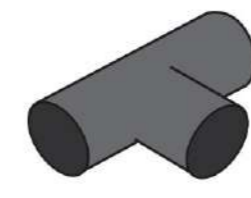

4x

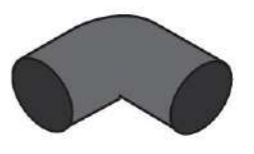

14x

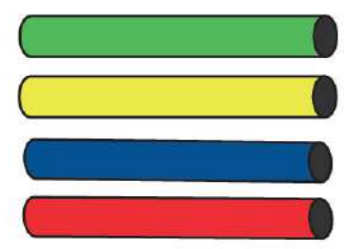

5x



# Table and Chairs

1

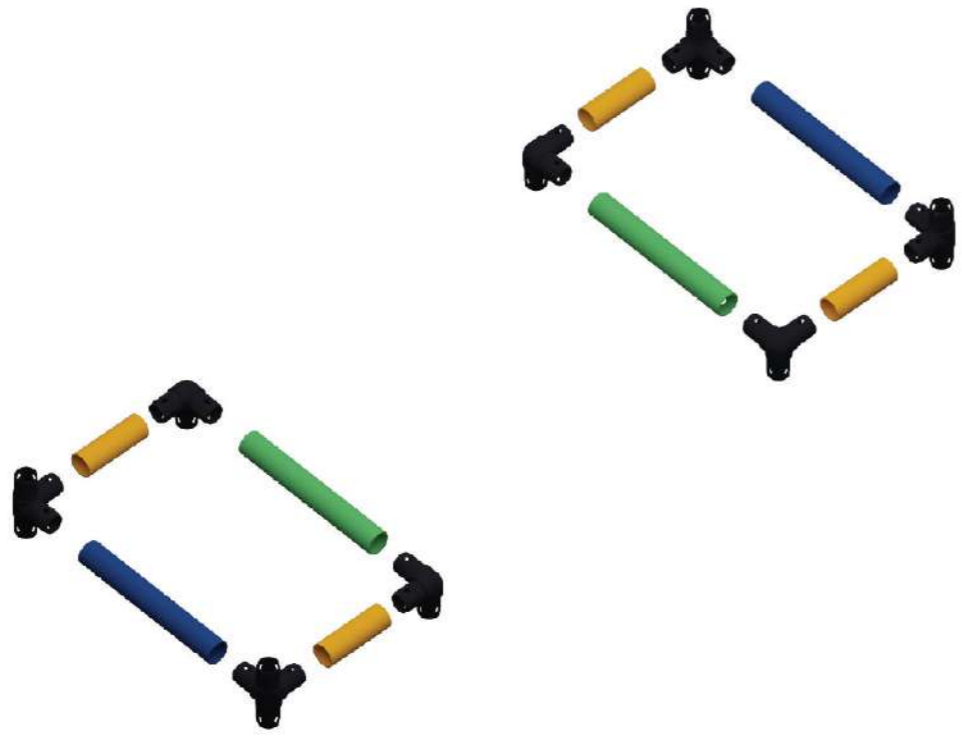

2

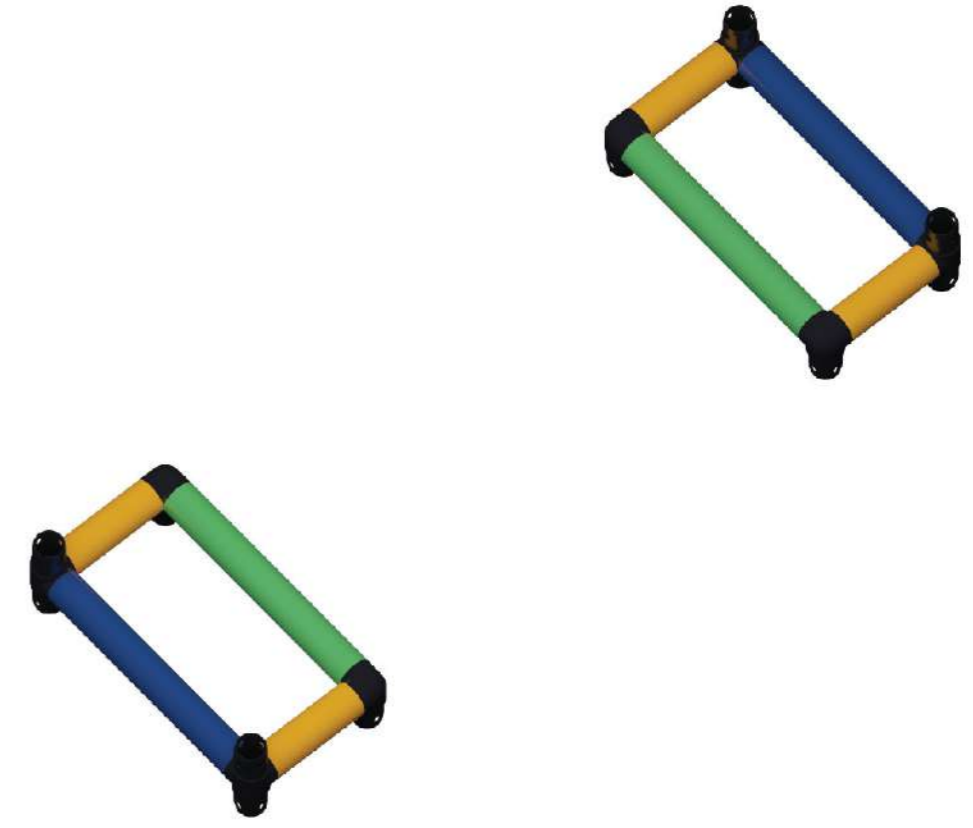

3

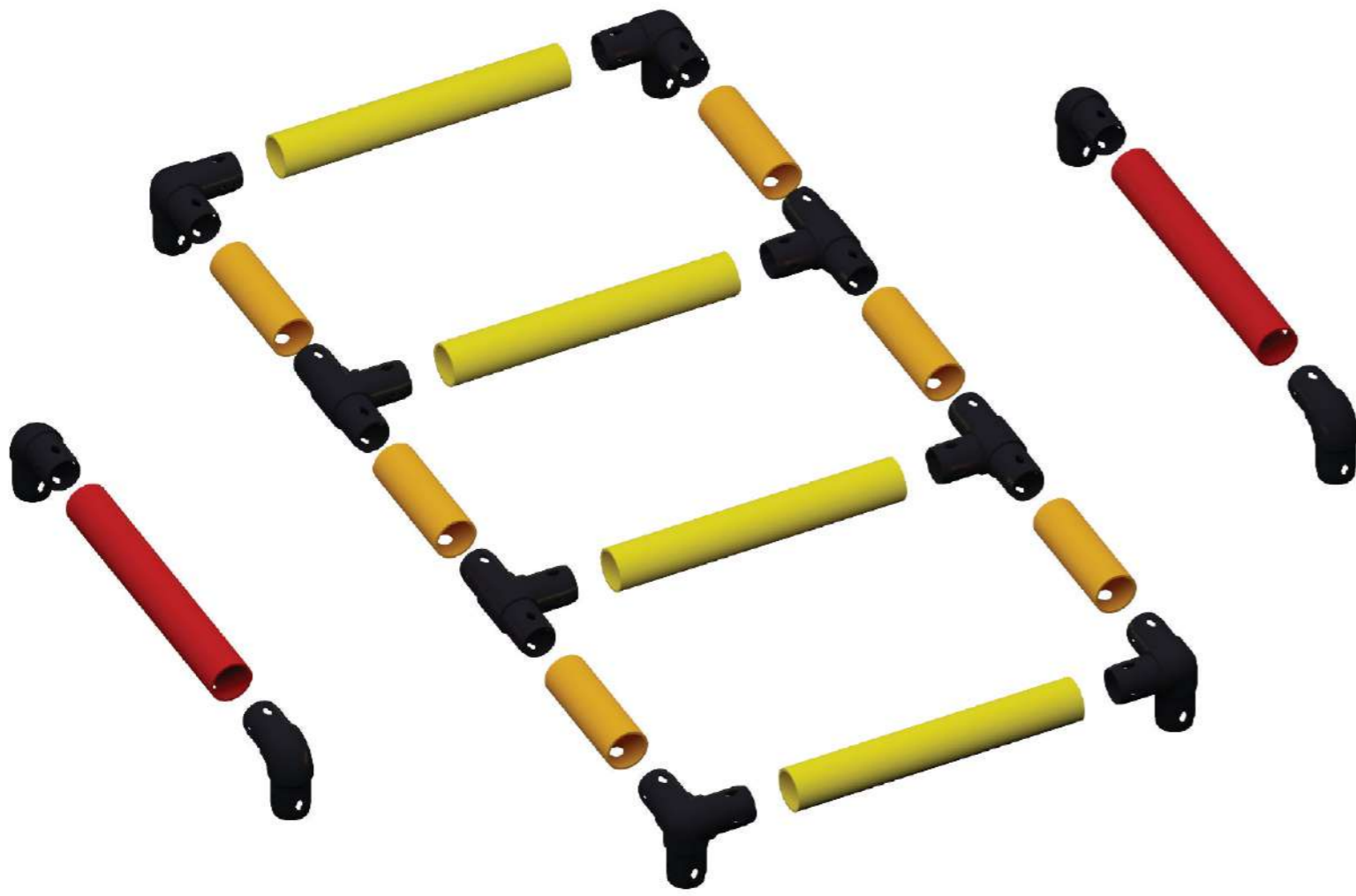

4



5

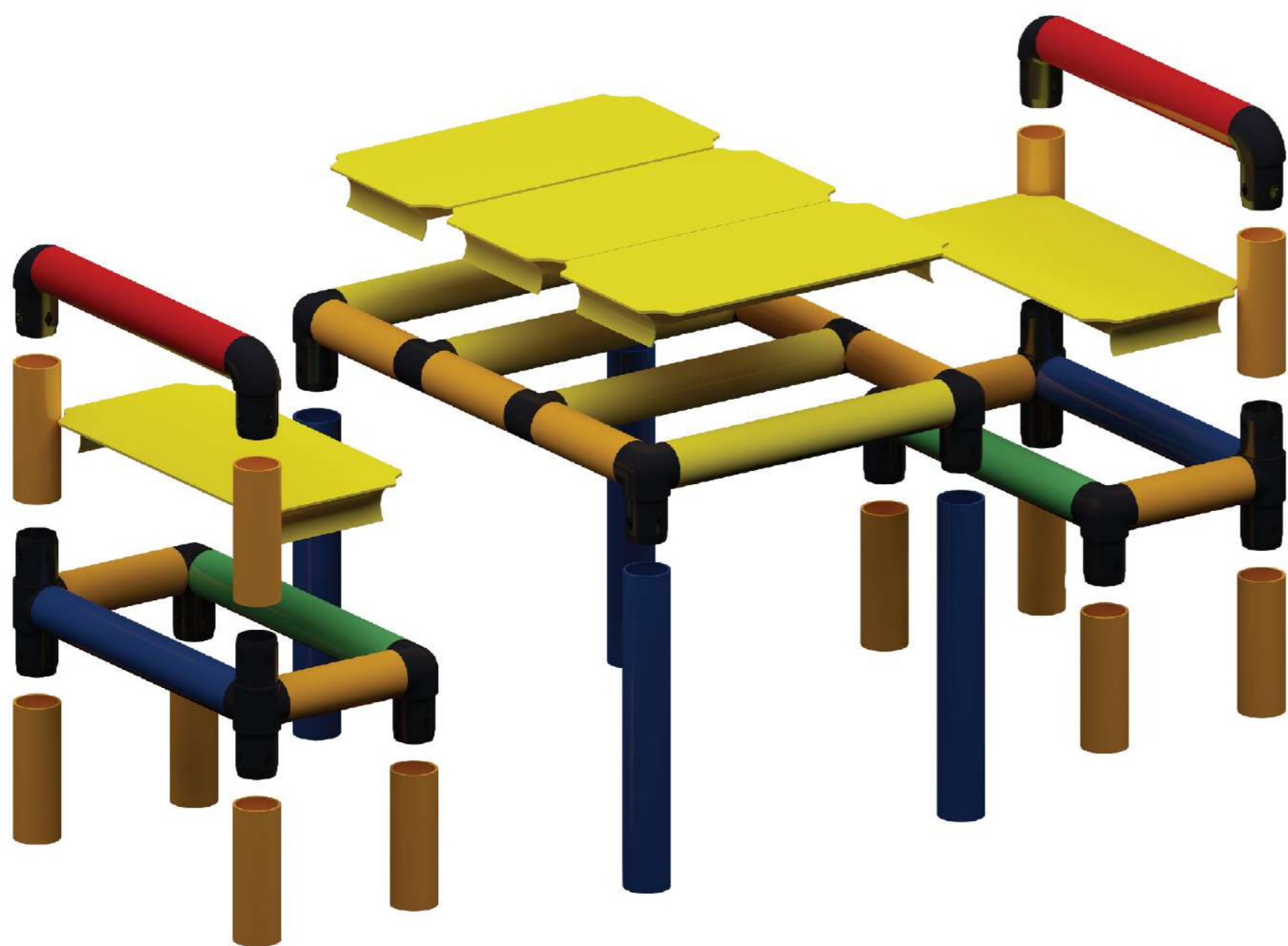

6



Insert Screws and Panels and Secure all Screws

Meet the Funphix Family! Collect them all!

CLASSIC SET FPCS-2



CLIMBING GYMS FP-CG-1

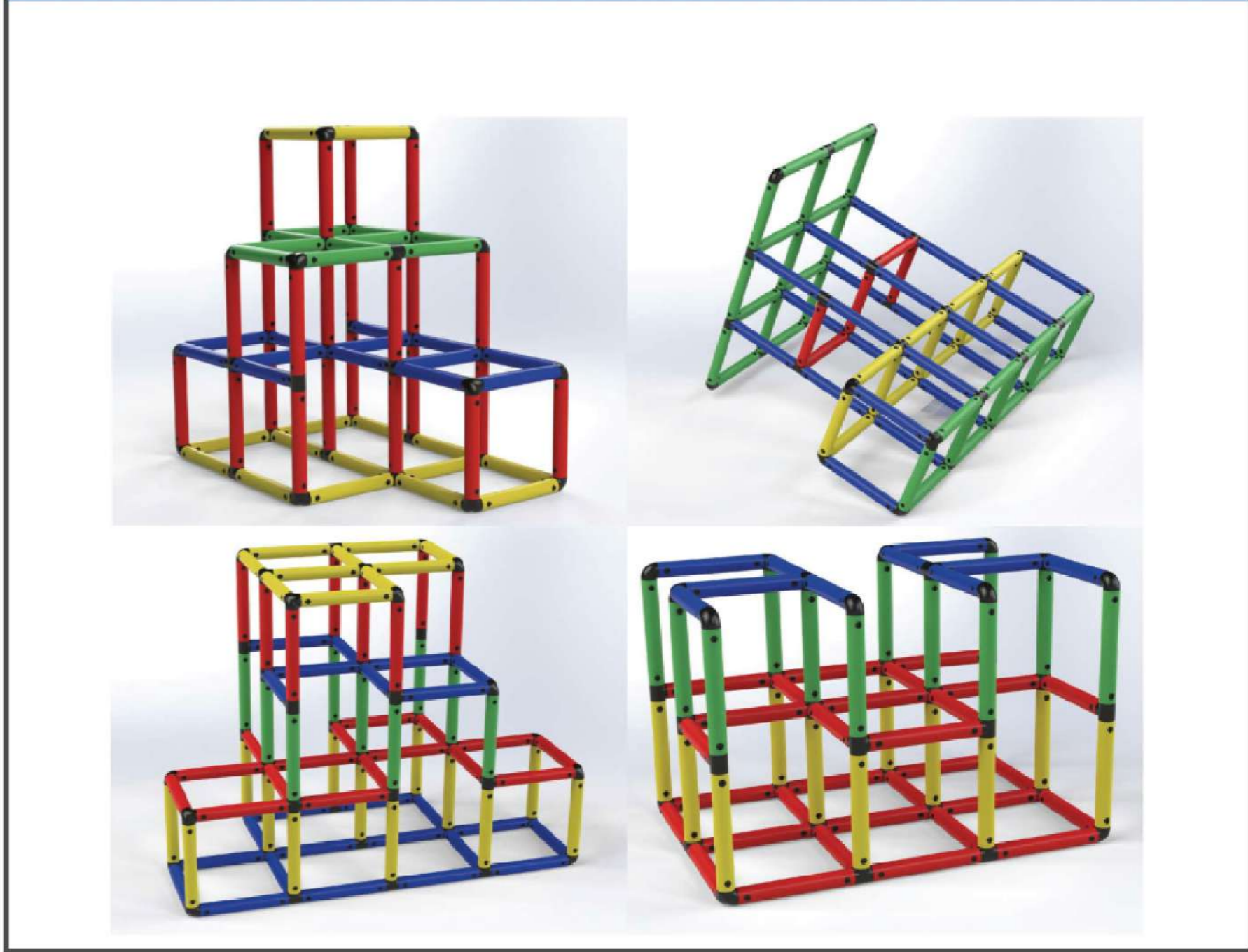

JUMBO SET FPJS-2



THE ALL-IN-1 SET FP-TA1-1



WHEELIES FP-W-1



Swimming Pool FP-SWP-1

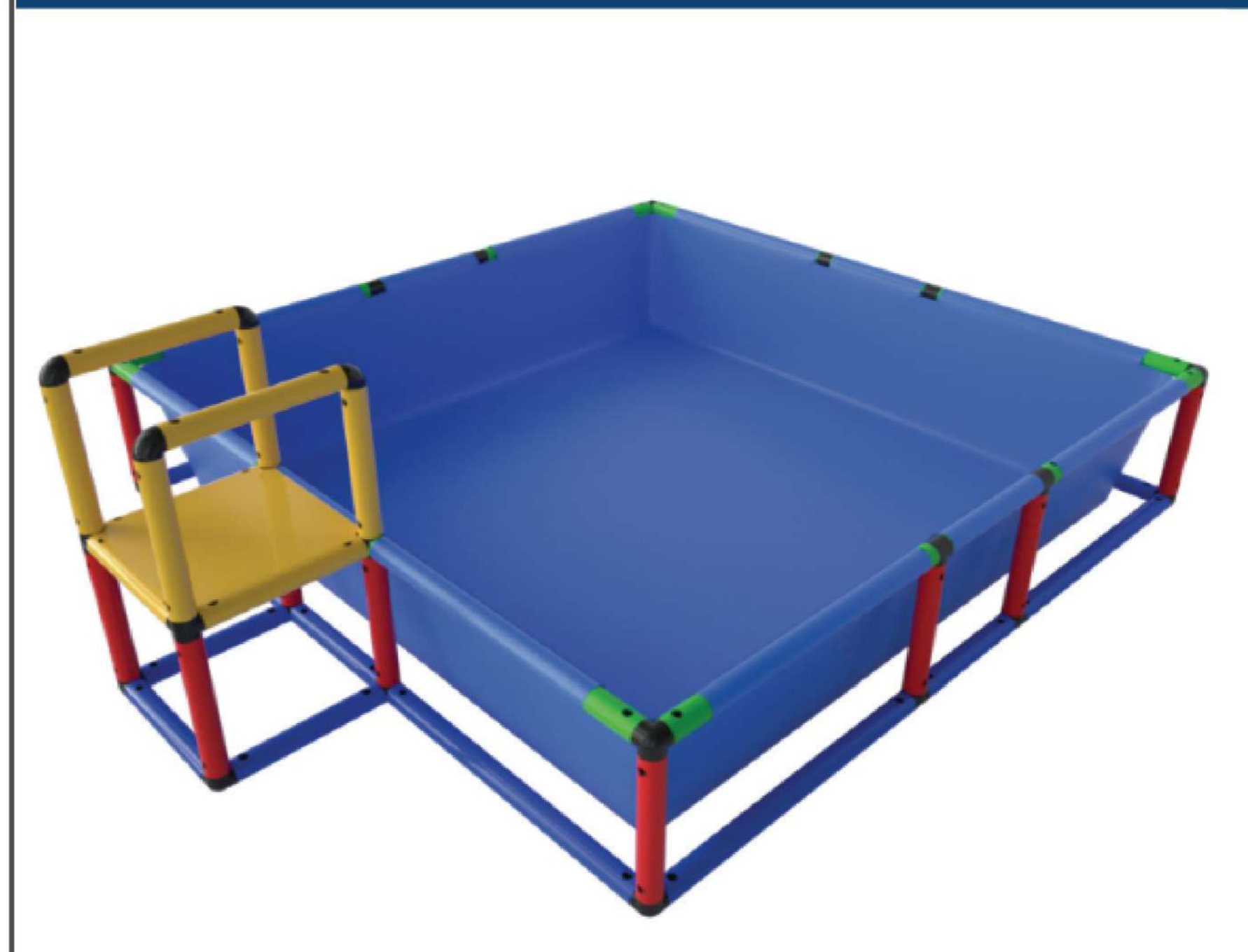

Meet the Funphix Family! Collect them all!

**Deluxe Set 296 PCS** FPDLX-1

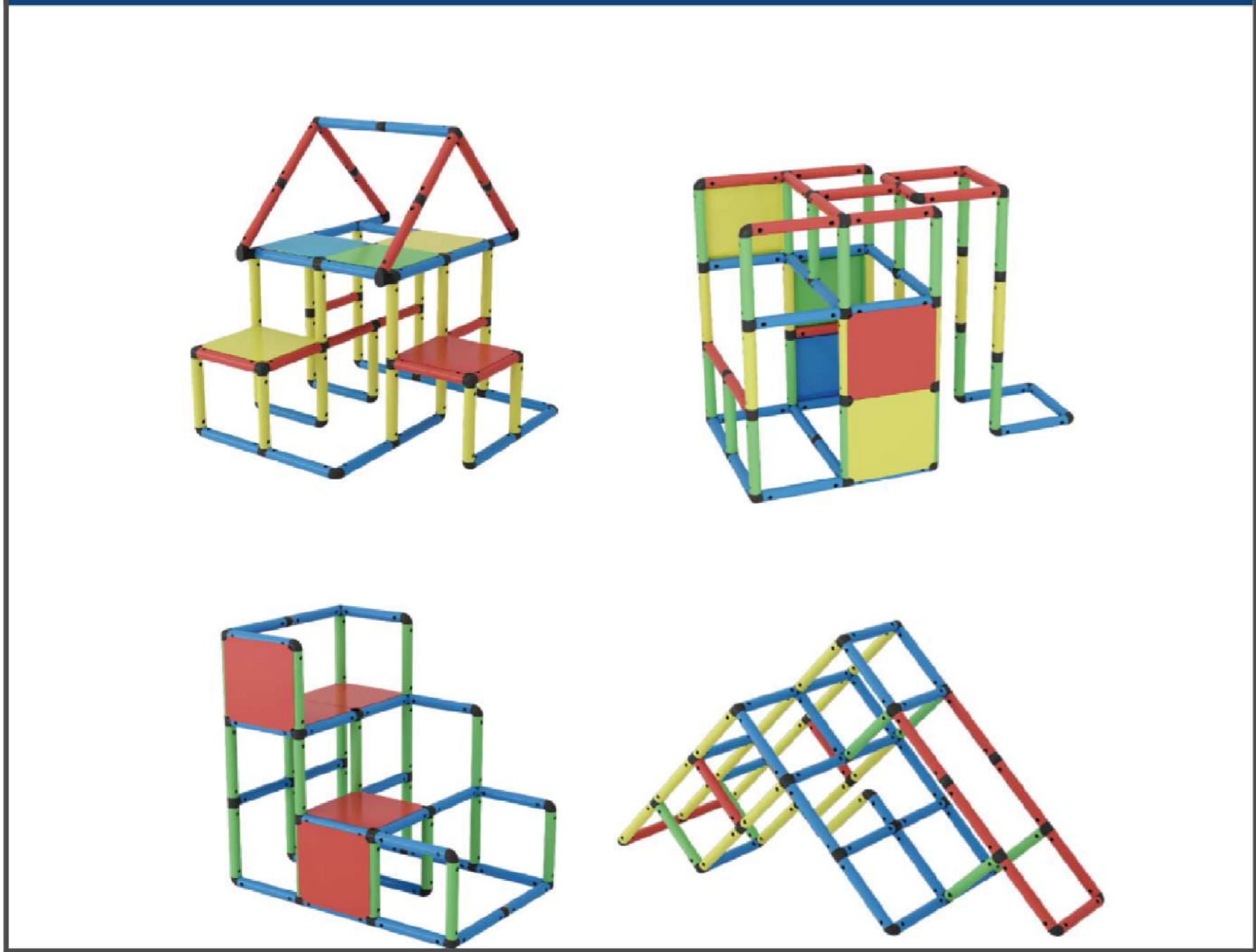

**TODDLER** FPTD-1

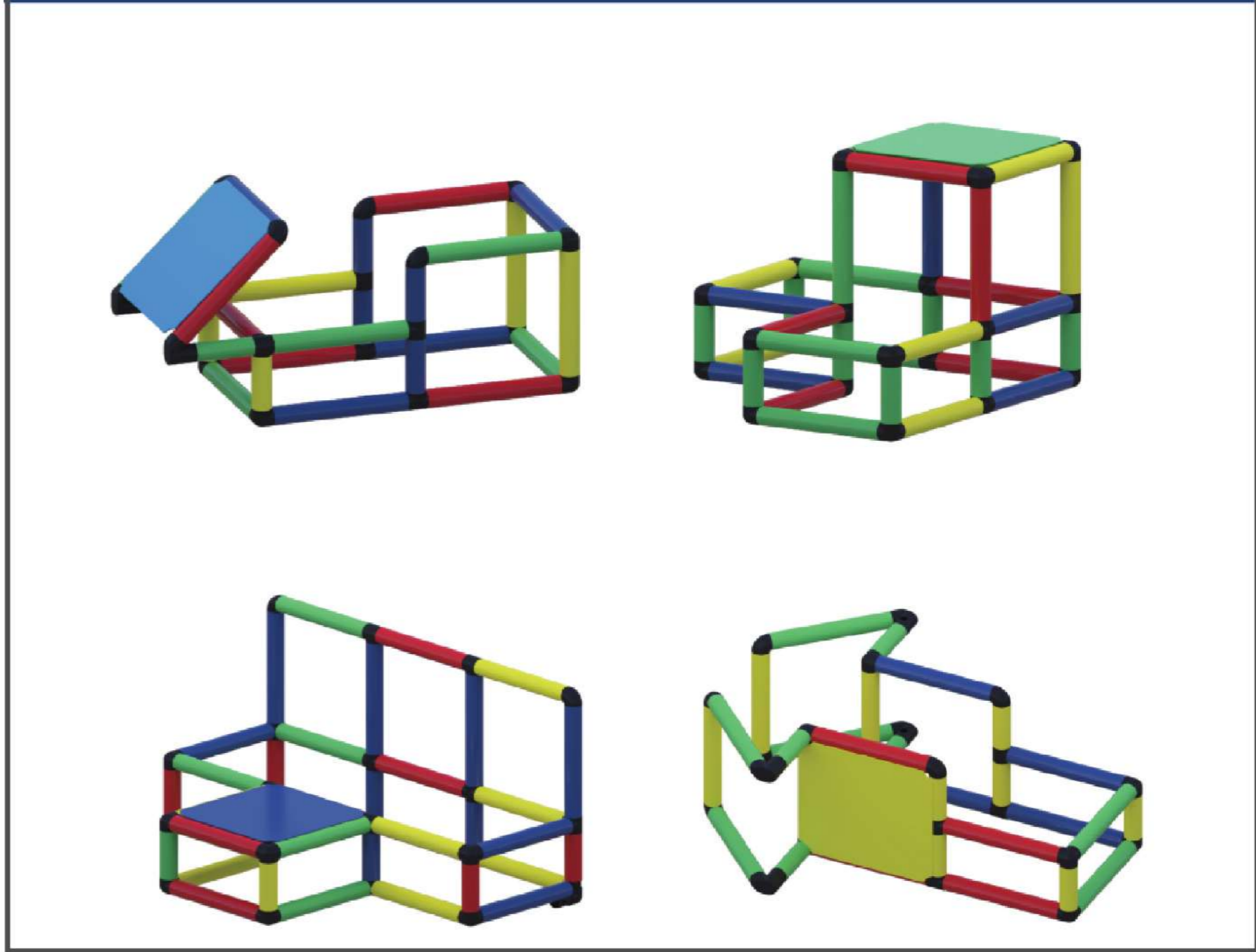

**SPORTS SET** FPSS-4B-1



**199 PCS STANDARD SET** FPSTND-1

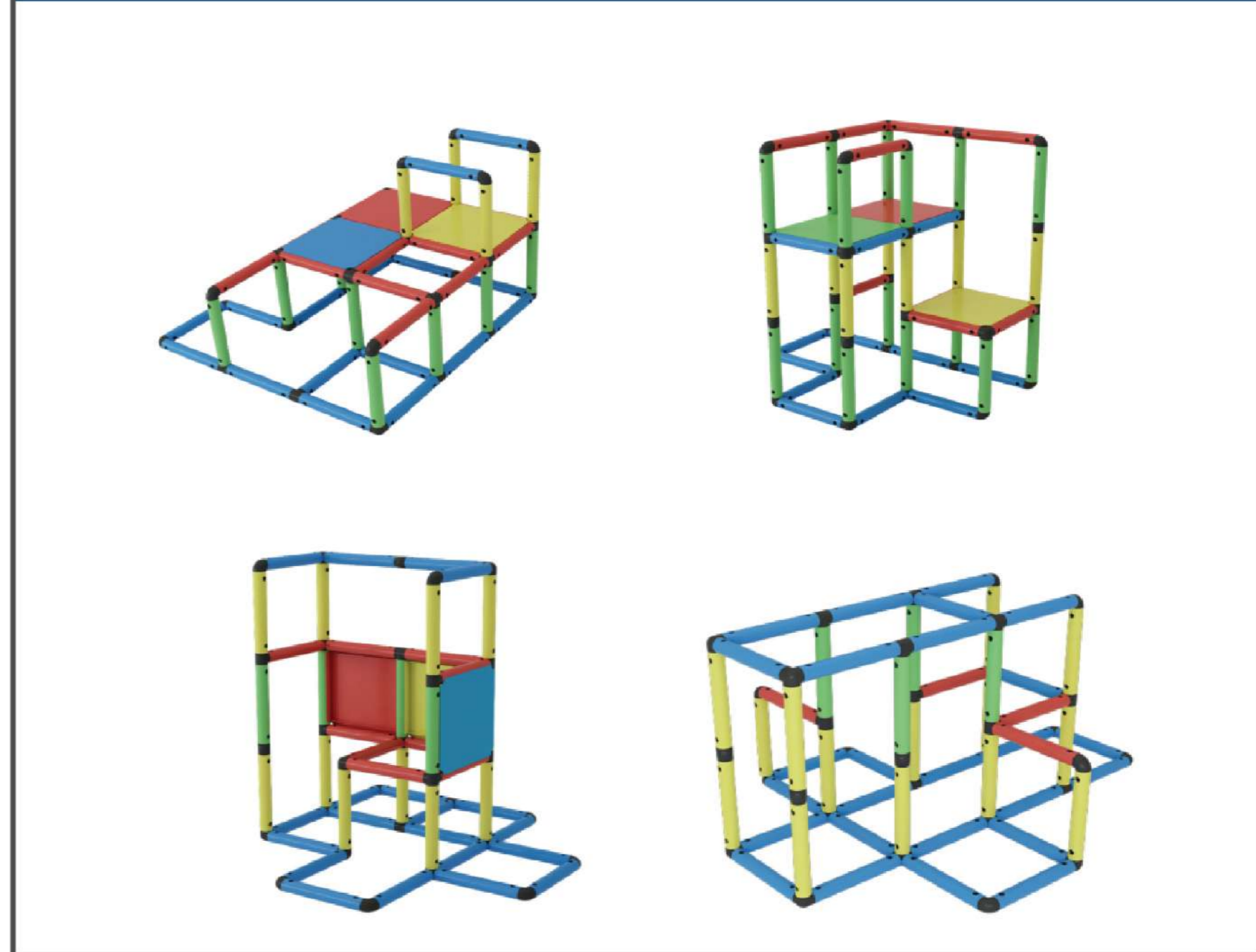

**FURNITURE SET** FPFS-BED



**BALL PIT SET** FPBPS-NET



Meet the Funphix Family! Collect them all!

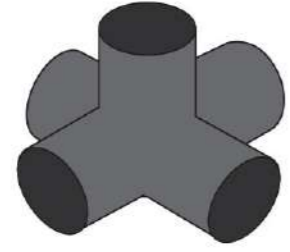

FP-CT-6  
5 way Connector X2

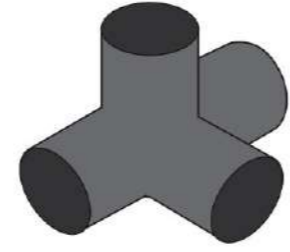

FP-CT-7  
4 way Connector X2

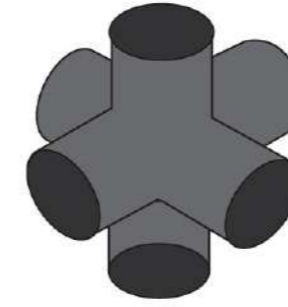

FP-CT-8  
6 way Connector X2

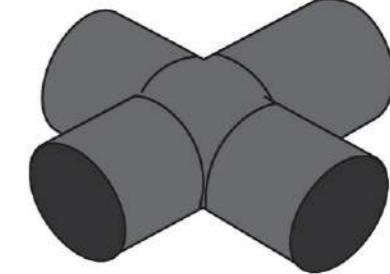

FP-CT-CR  
Cross Connector X2

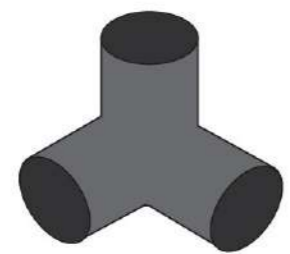

FP-CT-4  
3 way Connector X2

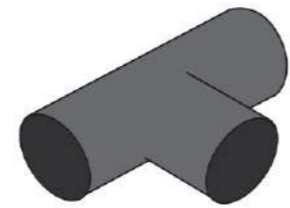

FP-CT-5  
T Connector X2

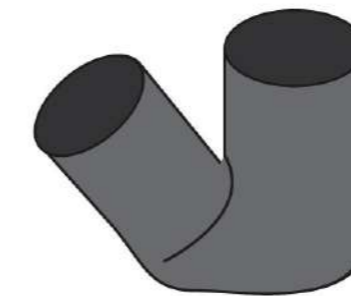

FP-CT-1  
Diagonal Connector X2

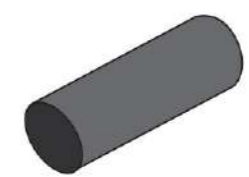

FP-CT-2  
2 way connector X2

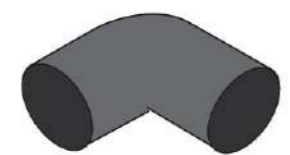

FP-CT-3  
Elbow connector X2

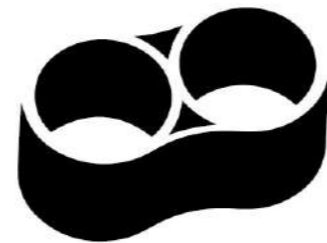

FP-C-DX  
Duplex Connector X2



FP-TU/2-Y  
5.8 Yellow Tubes X2

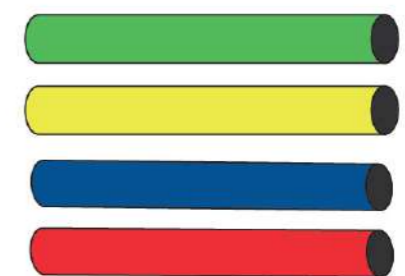

FP-TU-4  
13.5 Tubes In 4 Color



FP-SWP-LINER  
Funphix Swimming Pool Liner



FP-W-6  
Funphix Wheels X6

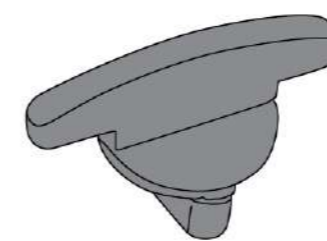

FP-PS-16  
Pack of 16 Panel Screws

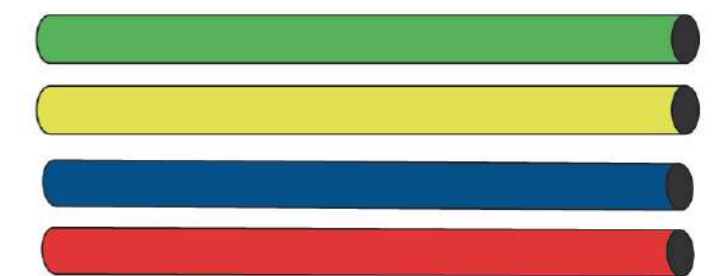

FP-TU-4L-C  
29.13" Tubes in 4 Color



FP-HP-B-1  
Half Panel - Light Blue



FPX-YBM  
Funphix Bed Mattress

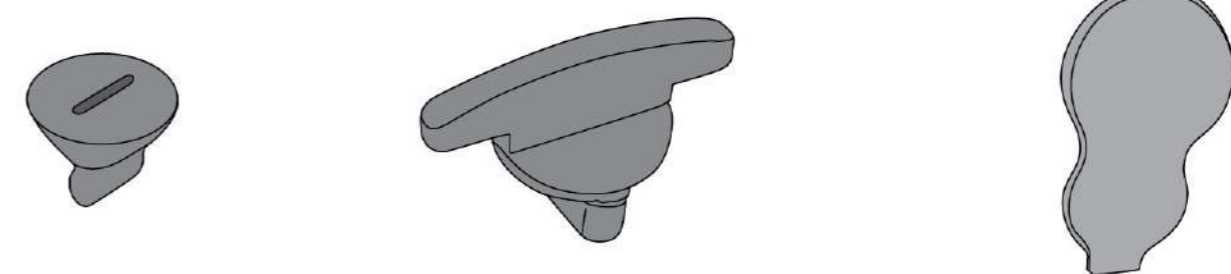

FP-T-50P-16-K  
Pack of 50 Tube Screws, 16 Panel Screws, 2 Keys

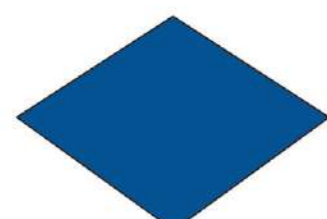

FP-PA-B-2  
Dark Blue Panel



FP-PA-B-1  
Light Blue Panel

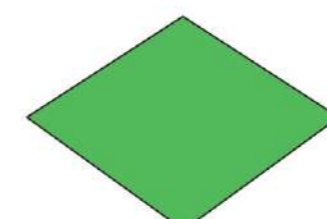

FP-PA-G  
Green Panel

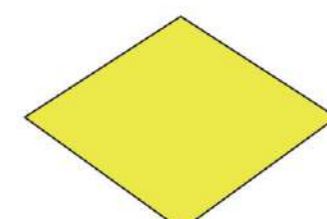

FP-PA-Y  
Yellow Panel

Meet the Funphix Family! Collect them all!



FP-4B-SS  
Funphix Set of 4 Balls - Soccer, Rugby, Basketball, Volleyball (Pump Included)

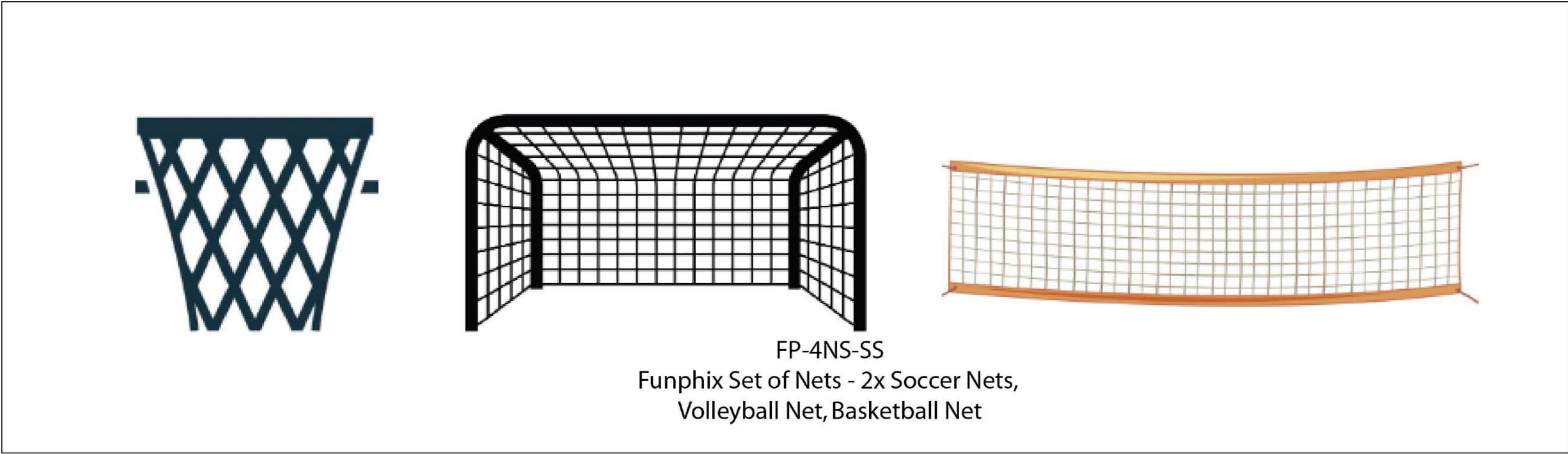

FP-4NS-SS  
Funphix Set of Nets - 2x Soccer Nets, Volleyball Net, Basketball Net



FP-AC-SS  
Funphix Sport Set Accessories - 4 Nets-2 soccer nets, 1 volleyball net, 1 basketball net; 4 Balls-Soccer, Rugby, Basketball, Volleyball; Pump; 20 Toss Rings-in 5 different sizes.

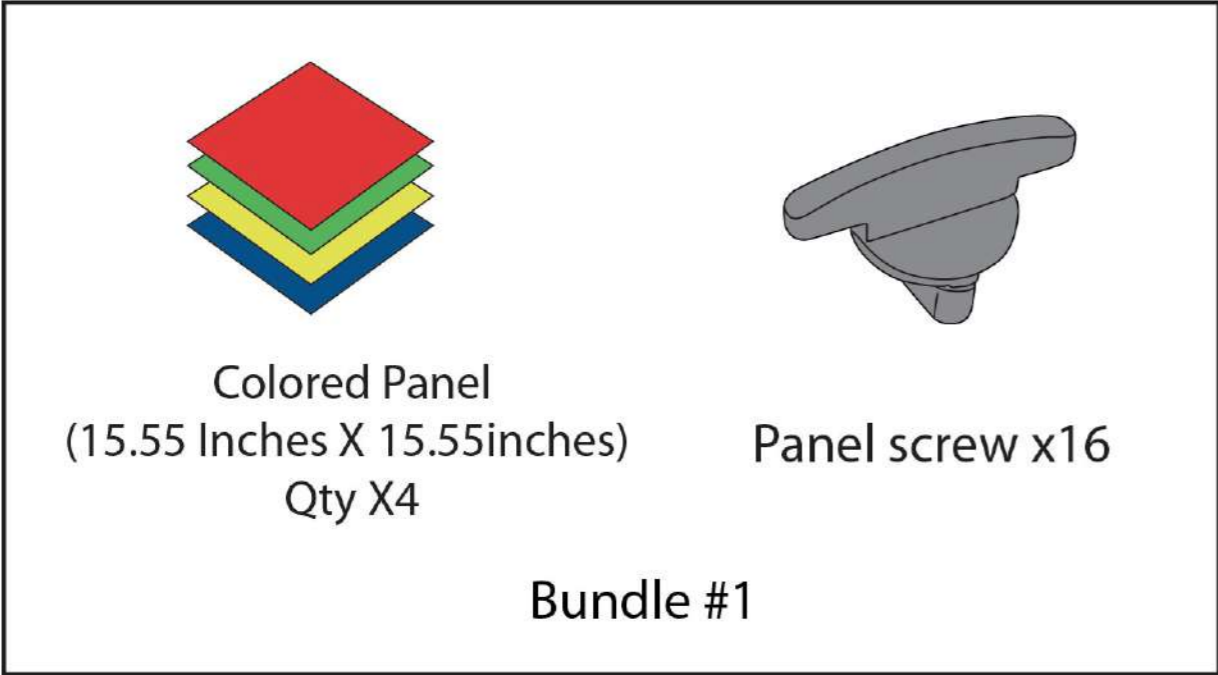

Colored Panel (15.55 Inches X 15.55inches) Qty X4

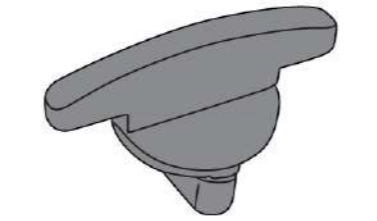

Panel screw x16

Bundle #1

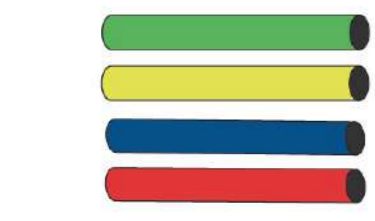
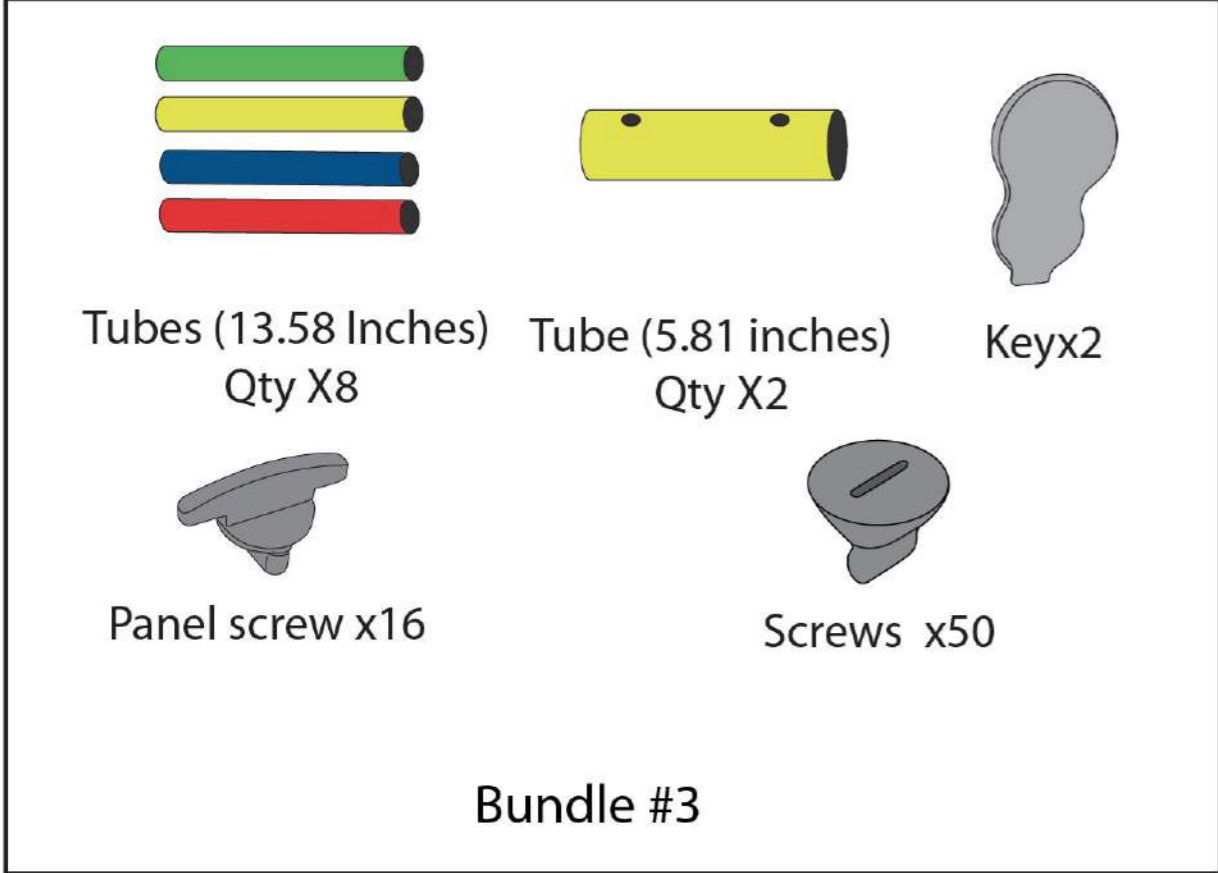

Tubes (13.58 Inches) Qty X8



Tube (5.81 inches) Qty X2

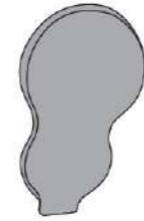

Keyx2



Panel screw x16



Screws x50

Bundle #3

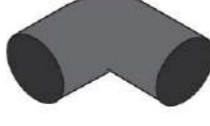
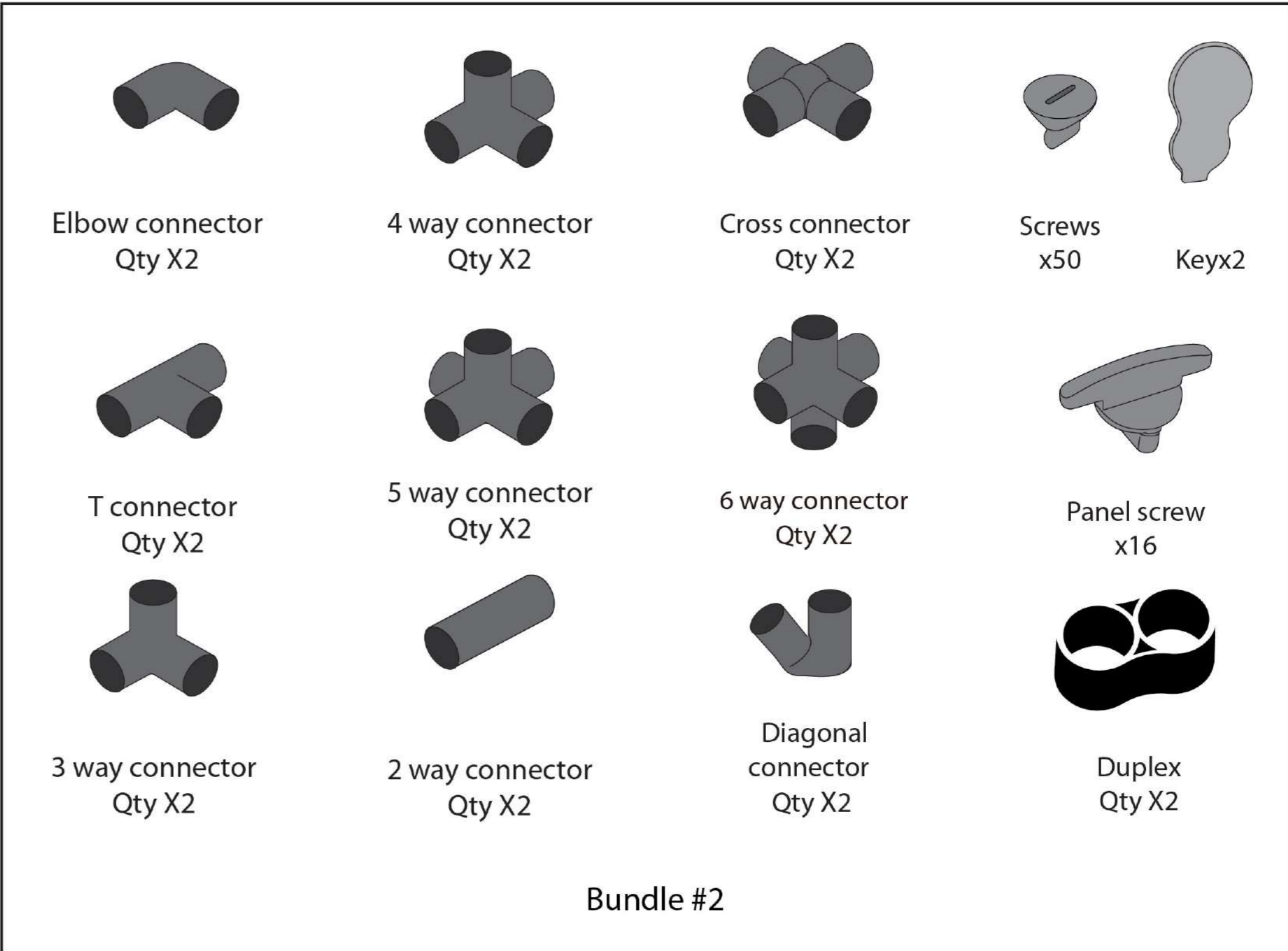

Elbow connector Qty X2

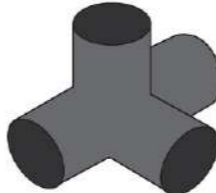

4 way connector Qty X2

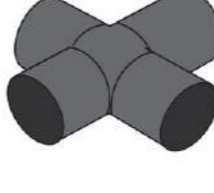

Cross connector Qty X2



Screws x50

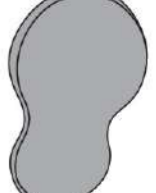

Keyx2

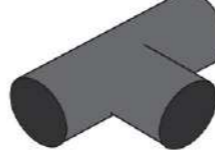

T connector Qty X2

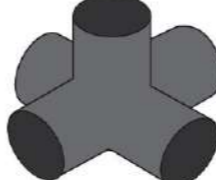

5 way connector Qty X2

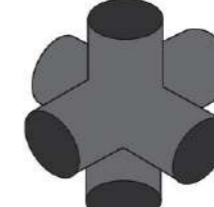

6 way connector Qty X2

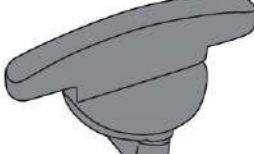

Panel screw x16

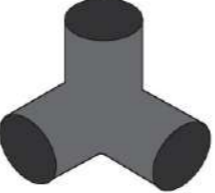

3 way connector Qty X2

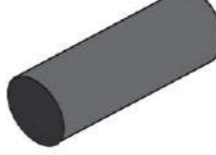

2 way connector Qty X2

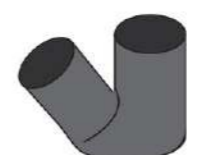

Diagonal connector Qty X2



Duplex Qty X2

Bundle #2

# Meet the Funphix Family! Collect them all!

Tubes (29.13Inches) Qty X8  
 Tubes (13.58 Inches) Qty X8  
 Tube (5.81 inches) Qty X2  
 Panel screw x16  
 Screws x50  
 Keyx2

**Bundle #4**

Funphix Swimming Pool Liner  
 Funphix Wheels X6

**Bundle #6**

Funphix Swimming Pool Liner  
 Tubes (29.13Inches) Qty X16

**Bundle #7**

5 way connector Qty X2  
 4 way connector Qty X2  
 Tubes (13.58 Inches) Qty X17  
 T connector Qty X4  
 Tube (5.81 inches) Qty X10  
 Colored Panel (15.55 Inches X 15.55inches) Qty X3  
 3 way connector Qty X4  
 Duplex Qty X2  
 Keyx1  
 Screws x65  
 Panel screw x15

**Bundle #9**

Elbow connector Qty X2  
 4 way connector Qty X2  
 Cross connector Qty X2  
 Screws x100  
 Keyx2  
 T connector Qty X2  
 5 way connector Qty X2  
 6 way connector Qty X2  
 Panel screw x32  
 3 way connector Qty X2  
 2 way connector Qty X2  
 Diagonal connector Qty X2  
 Duplex Qty X2  
 Tubes (13.58 Inches) Qty X8  
 Tube (5.81 inches) Qty X4  
 Colored Panel (15.55 Inches X 15.55inches) Qty X4  
 Tubes (29.13Inches) Qty X8

**Bundle #5**

Elbow connector Qty X4  
 4 way connector Qty X2  
 Tubes (13.58 Inches) Qty X11  
 Screws x50  
 T connector Qty X4  
 Tube (5.81 inches) Qty X6  
 Colored Panel (15.55 Inches X 15.55inches) Qty X2  
 Panel screw x16  
 3 way connector Qty X4  
 Duplex Qty X2  
 Diagonal connector Qty X2  
 Keyx2

**Bundle #8**

To explore all our additional items and for more information check out our website

[www.funphix.com](http://www.funphix.com)

Feel free to contact our friendly staff for any questions or additional information at  
[support@funphix.com](mailto:support@funphix.com)



**Build with it - Play on it™**

© Funphix, All Rights Reserved.