

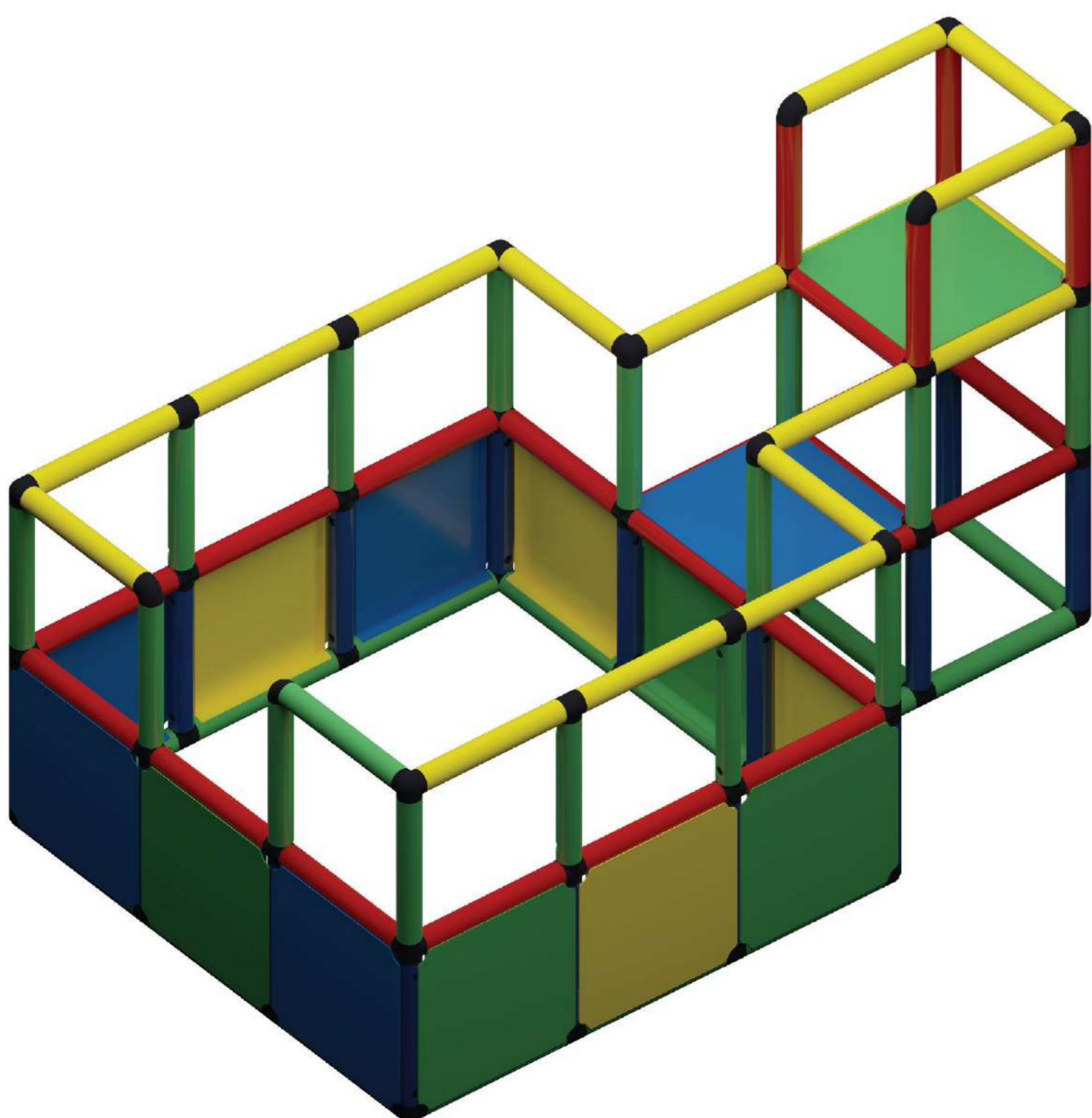

Build with it - Play on it™

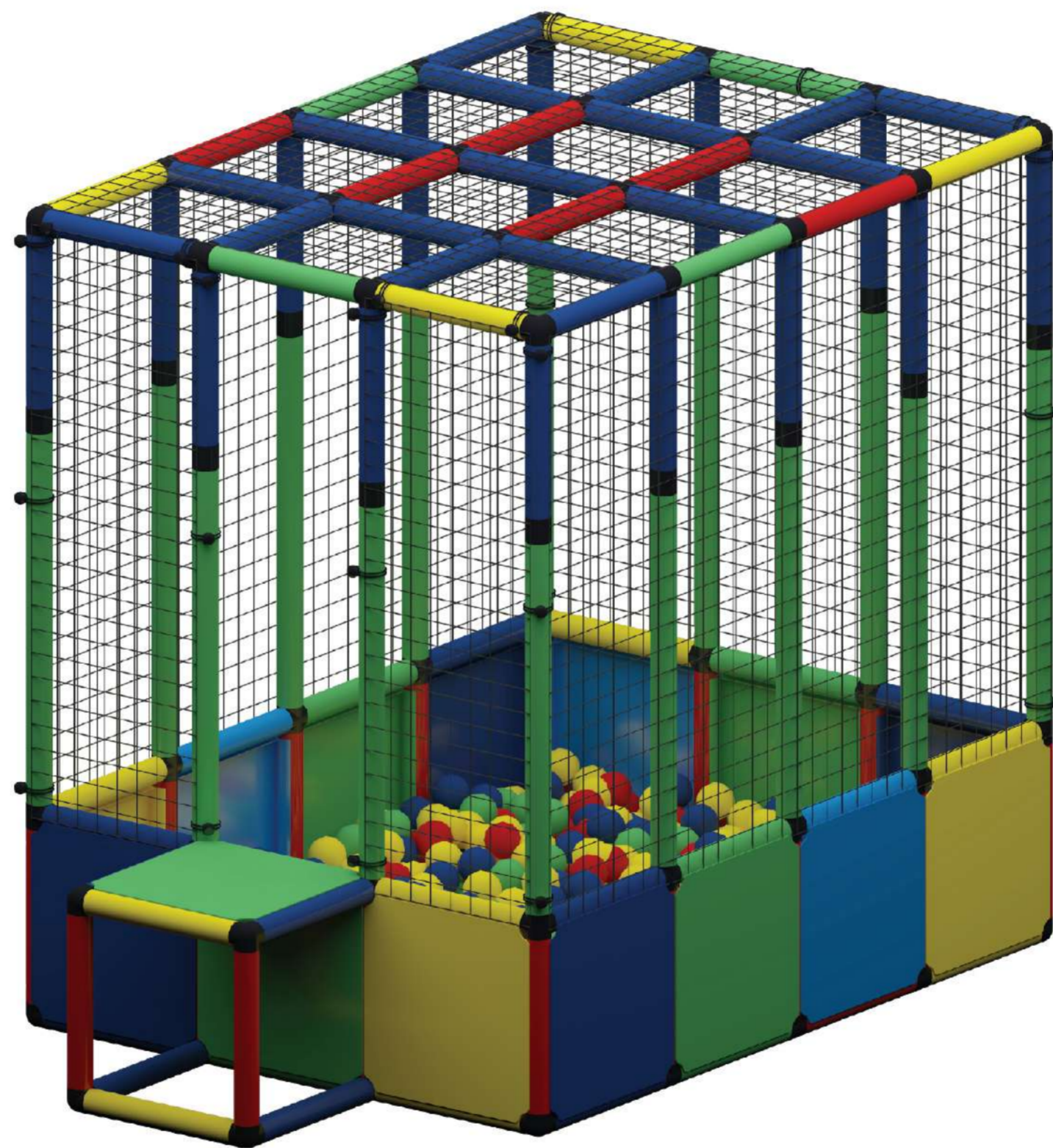

FUNPHIX CREATE AND PLAY LIFE-SIZE STRUCTURES BALL SET



Before you begin to use this toy, you must read all the information in this manual.

Warning:

Do not sit, stand, or climb or play on your structure until all screws are secured into their place. A screw must be inserted into the tube hole that aligns with the connector for the toy to be safe and secure. The screws must be inserted on both ends of each tube. The toy will fall apart without the screws in place.

- You can only apply weight on the panels, when you secure the panels with the panel screws, to the supporting tubes on all four sides. Never push the panels out from the inside, always remove them carefully by first removing screw fasteners .

- Throwing the panel may result in the panel chipping at the edges.

- All play structures need to be assembled and tested by an adult "supervisor", according to the instructions and safety standards listed below.

- The product is intended for home/domestic use only and is not suitable for professional or commercial use, nor for municipal playgrounds.

- When you assemble a play structure, follow the exact instructions in the manual.

- Place the bottom supports of play structure on a flat surface. Do not place your structure on an elevated or inclined surface, your play structure should always be at floor level or ground level.

- Whether used indoors or outdoors, place the structure on a safety floor material i.e. Carpet, mats grass ,shredded tire etc.

Supervision and playing

1. An adult must always be present to watch over the children when they are building, playing or using the structures. Parents are liable for the children's actions.
2. Children Play on the play structures at their and their parent's own risk
3. Do not misuse the play structures, use it for the purpose it was intended.
4. The maximum weight on the structures is a total of 150Lbs.
5. No play should be allowed on structures which have not been completed, been damaged, or destroyed, or altered ,or partially or fully unassembled.
6. Do not use the play structure when the parts of the structure reach a temperature of 100 degrees F.
7. Ensure that the environment around the structure is safe and that no flame or heat producer or anything hazardous is near.
8. Do not use or store the product next to any fire.
9. Do not use any broken parts.
10. Do not throw the tubes or panels.

Maintenance

- Inspect your play structure before each use, make sure there are no loose contents, missing parts, screws, or broken pieces. Any missing or damaged pieces should be replaced immediately.
- Maintain the pieces by periodically washing the play structures with warm water and a little detergent. Do not use any harsh detergent or compounds on the surfaces.
- The color of the plastic pieces may fade by sunshine, you can however use them indoors and outdoors. Store indoors, and if left outside for a long time make sure to cover it and protect everything with a cloth.
- Not following these guidelines is not only dangerous to children, but will also immediately void any warranty.

Warning:

This package has small parts that can be swallowed! Not for children under 3 years. There is danger of choking and/or suffocation!

Parts list

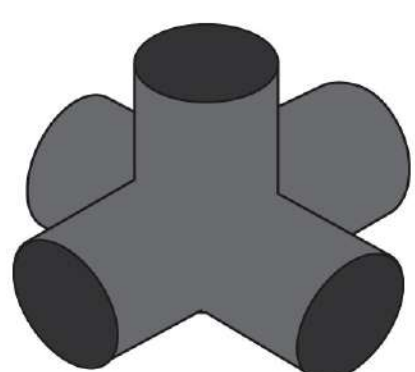

5 way connector
Qty X6

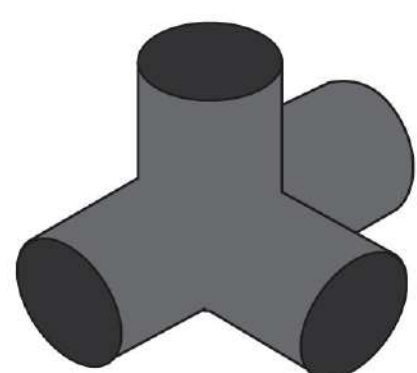

4 way connector
Qty X16

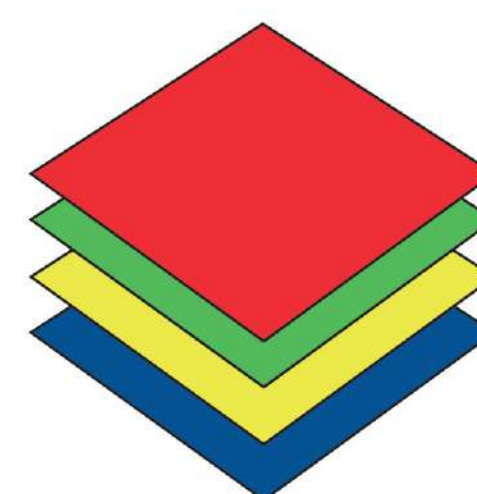

Colored Panel
(15.55 Inches X 15.55inches)
Qty X15

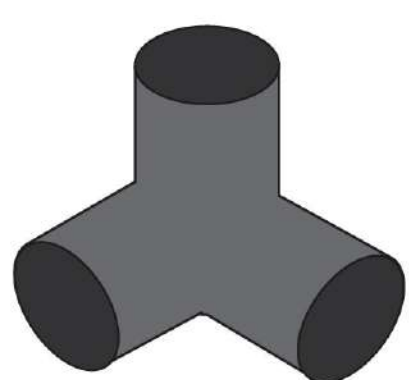

3 way connector
Qty X14

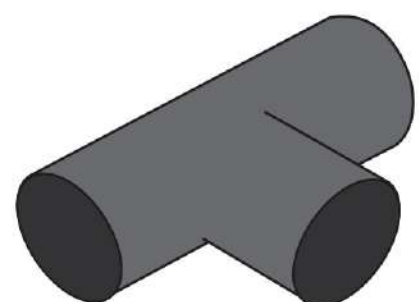

T connector
Qty X10

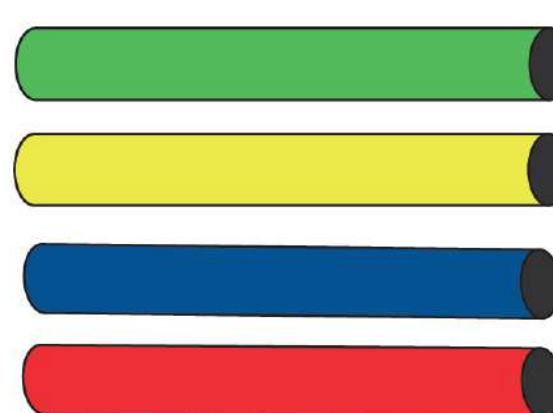

Tubes (13.58 Inches)
Qty X96

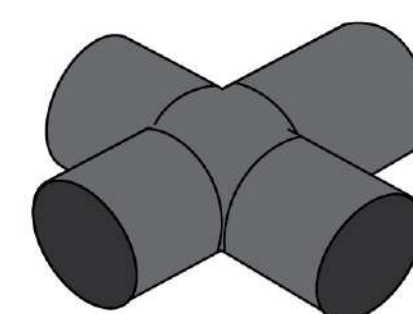

Cross connector
Qty X14

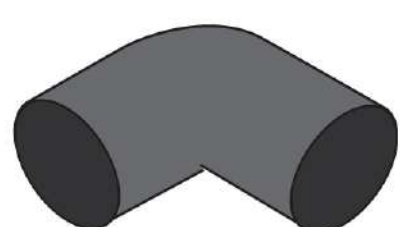

Elbow connector
Qty X4

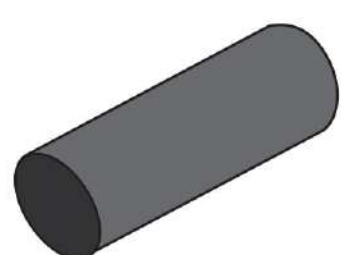

2 way connector
Qty X14



Screws
Qty X160

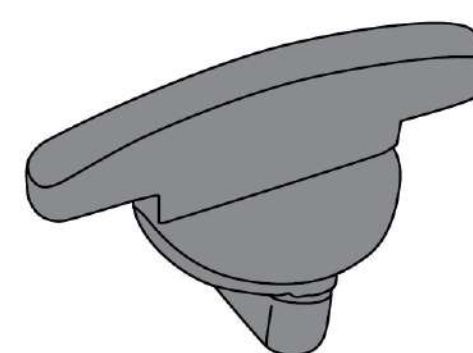

Panel screw
Qty X60

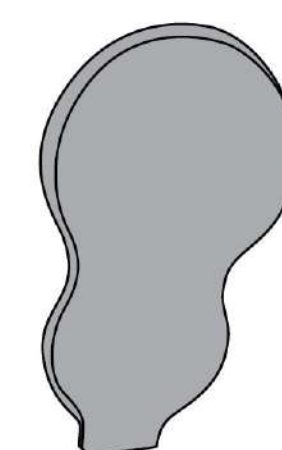

Key
Qty X2



bungee cords X25

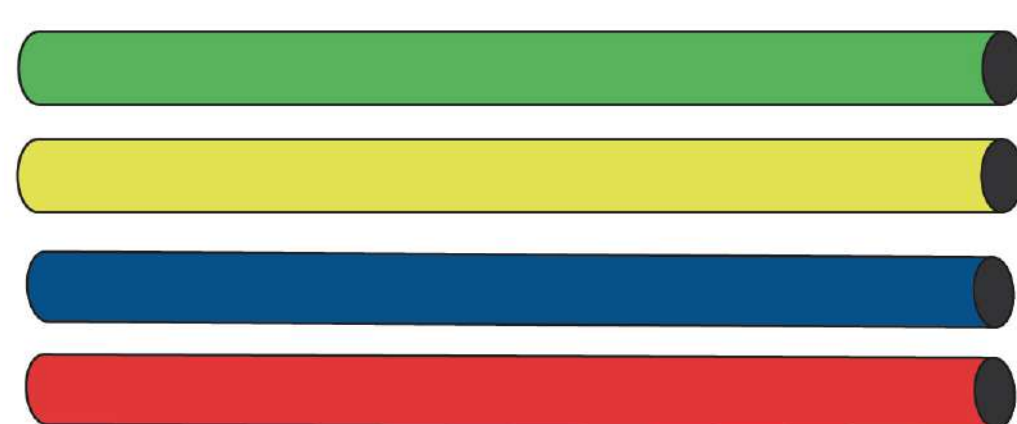

Tubes (29.13Inches)
Qty X14

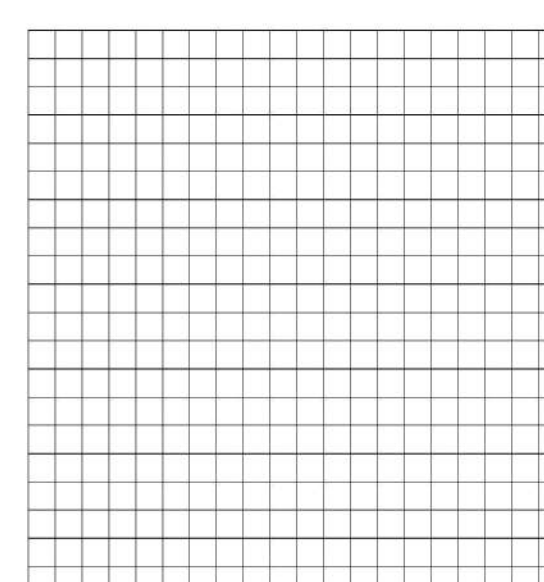

Net
Qty X1

Instructions on How to assemble structures

- The screws are secured as well as removed by insertion of tube over connector followed by a screw through both tube and connector's aligned holes, followed by a 90 degree turn.

To detach the tube from the connector, first remove the screw by turning it back 90° then turn the tube slightly and remove it from the connector.

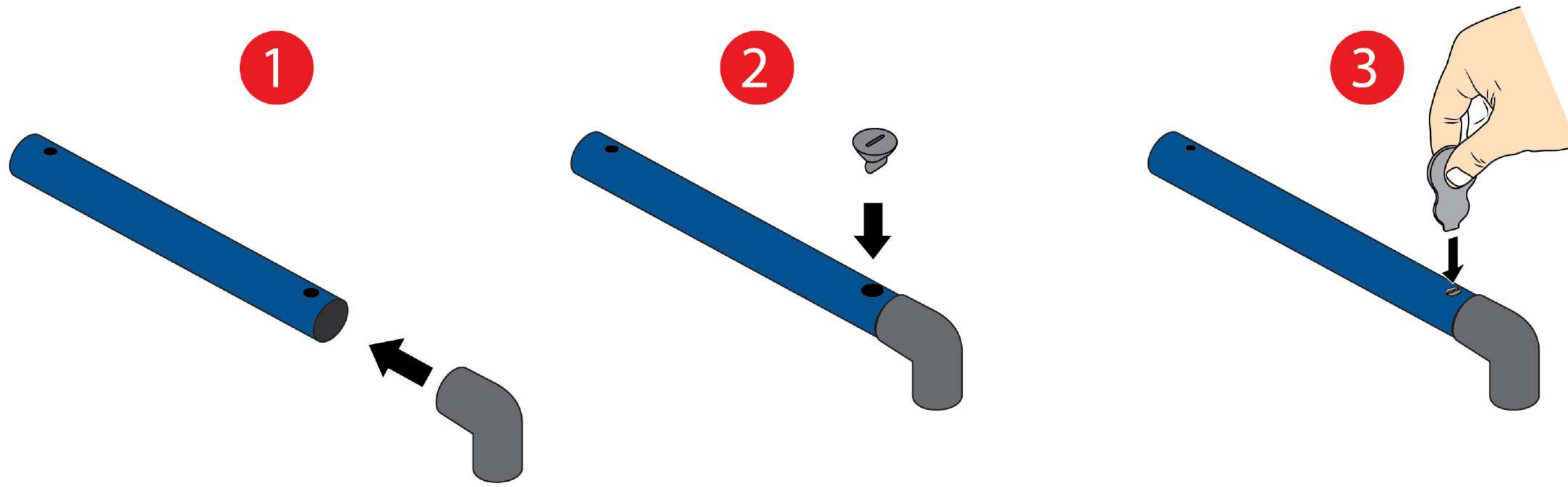

- It will be simpler to build a structure from the base up, complete the first level and then continue on to the next level just above. Insert the screws only after the structure is completely assembled. When inserting the screws, also work your way up starting from the bottom up completing upwardly each level.

- Prepare your structures of tubes and connectors beforehand, so that you will not have to force any pieces, See image below showing correct assembly and incorrect assembly.

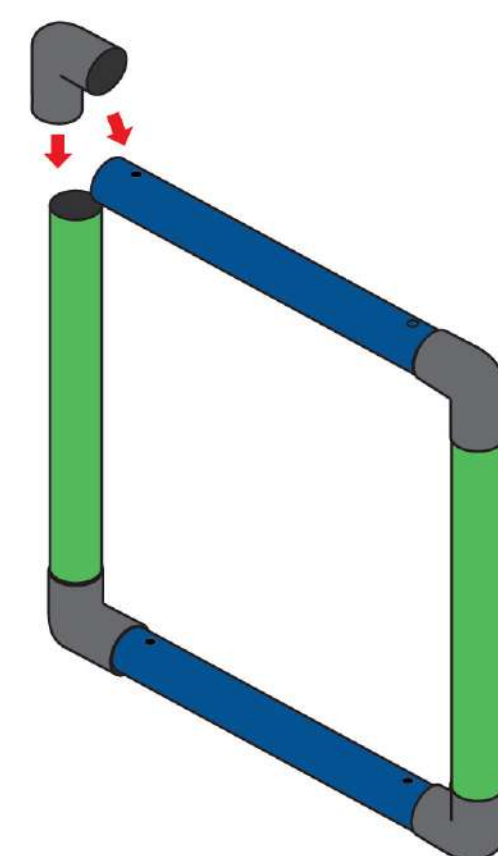
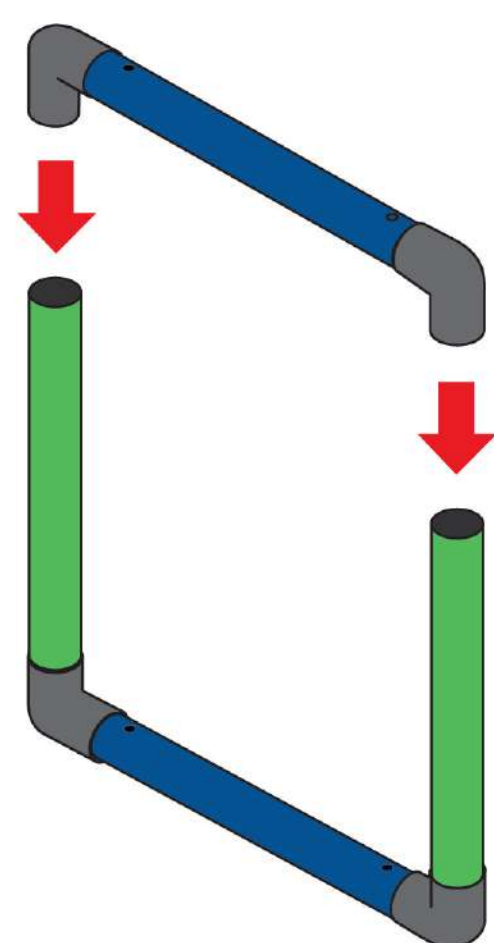

- Remember when inserting the screws for the tube and connector where you want to insert panels as those places will be secured by the required panel screws. Each tube only has 2 screw holes and therefore you will have to ensure that the panels are put extending in different directions when sharing the same tubes. So that you can insert the necessary panel screws in each panel hole and tube . See image below.

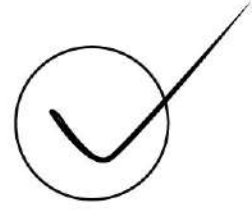

- When assembling your own structure, always make sure to build a stable support by adding to the width, as you are making the structure taller .

Make sure to test your self-designed structures to ensure they are stable and safe and will not tip over. Do not build tall or wobbly structures.

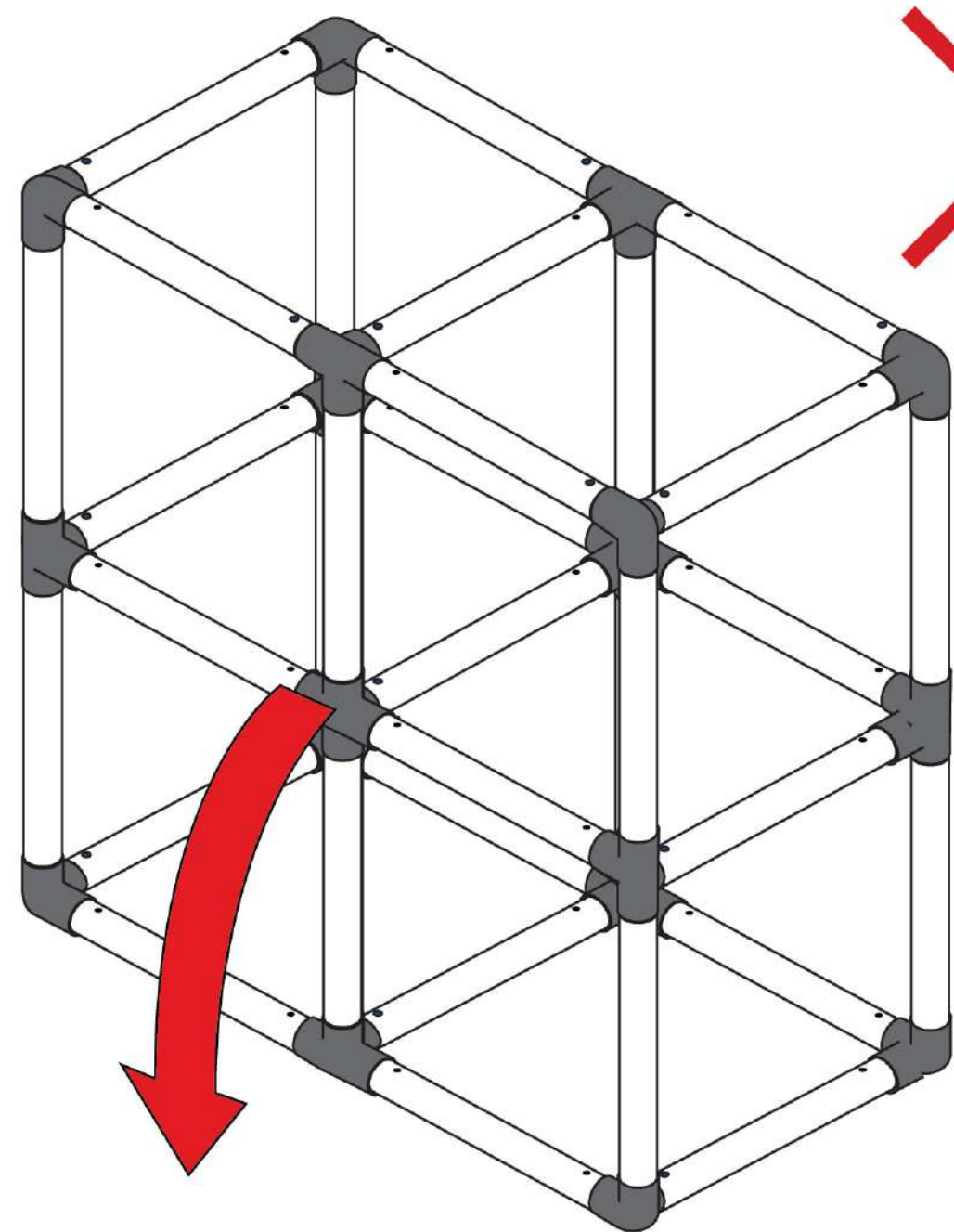
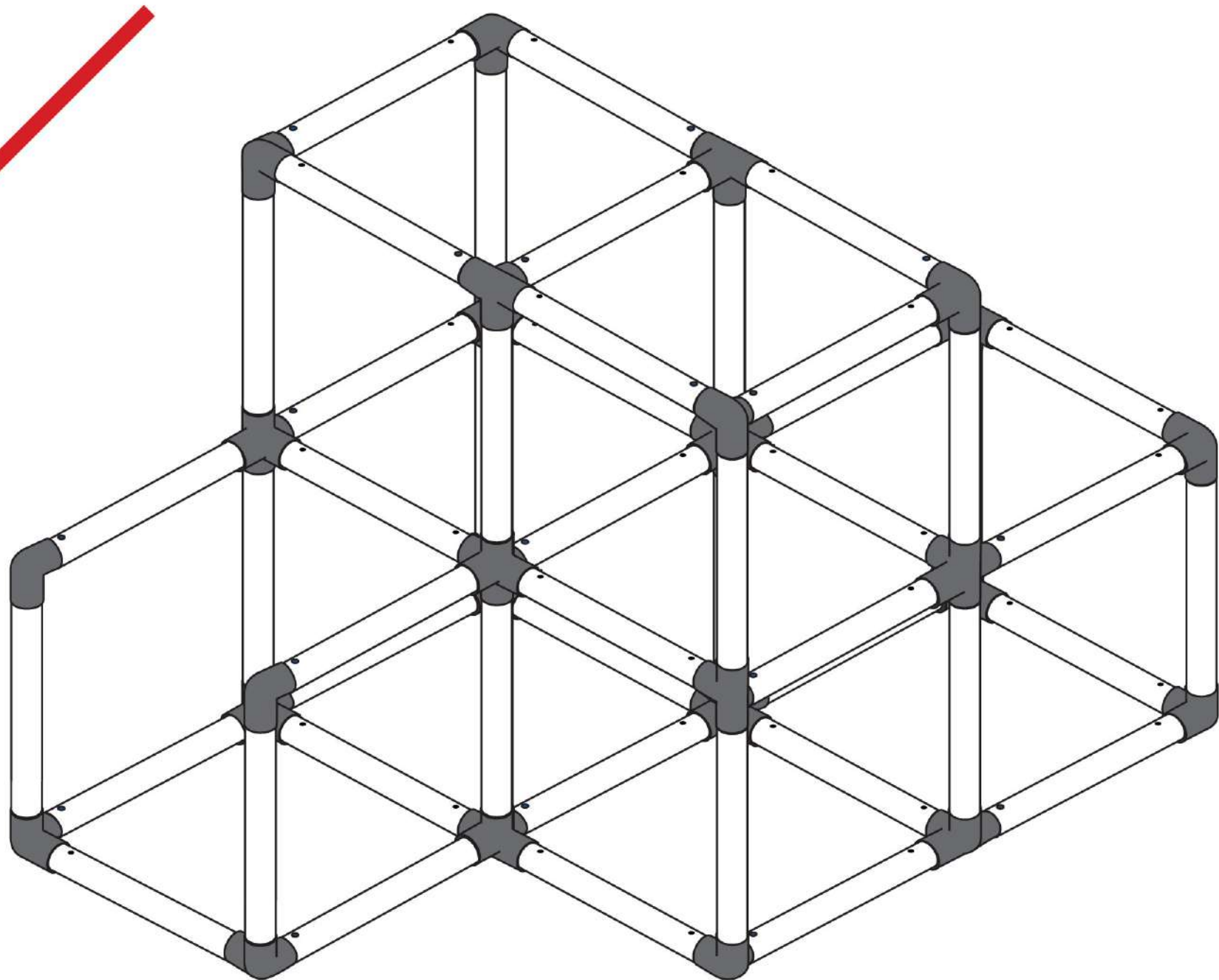

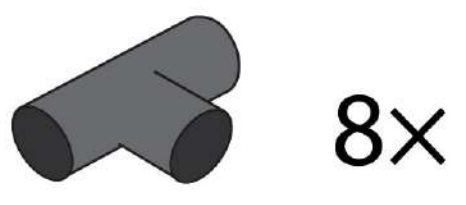

8x

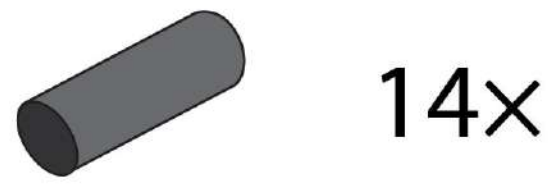

14x

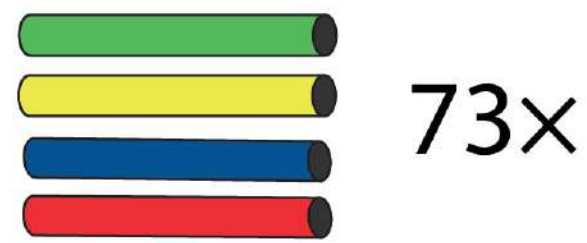

73x

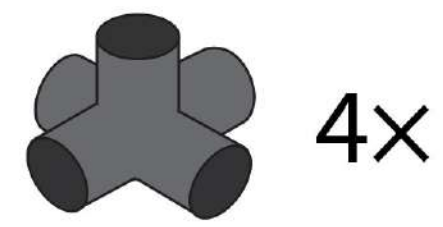

4x

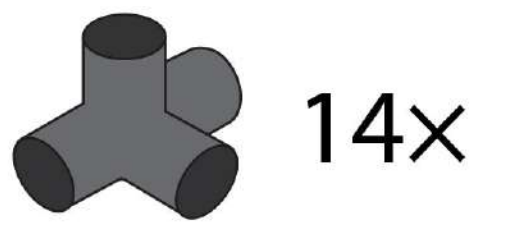

14x



25x

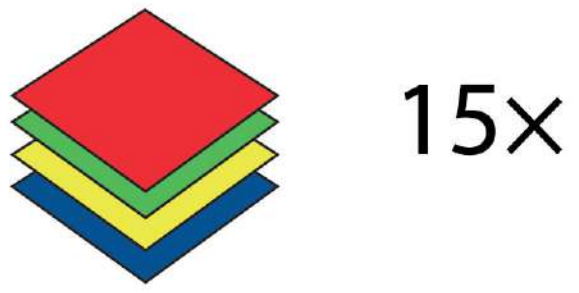

15x

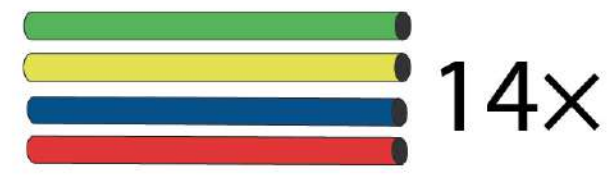

14x

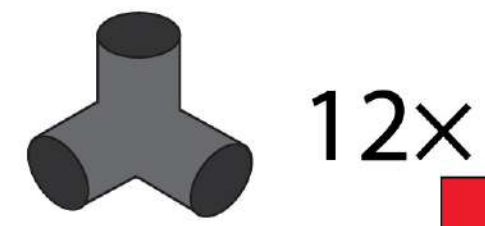

12x

Large Ball Pit

1

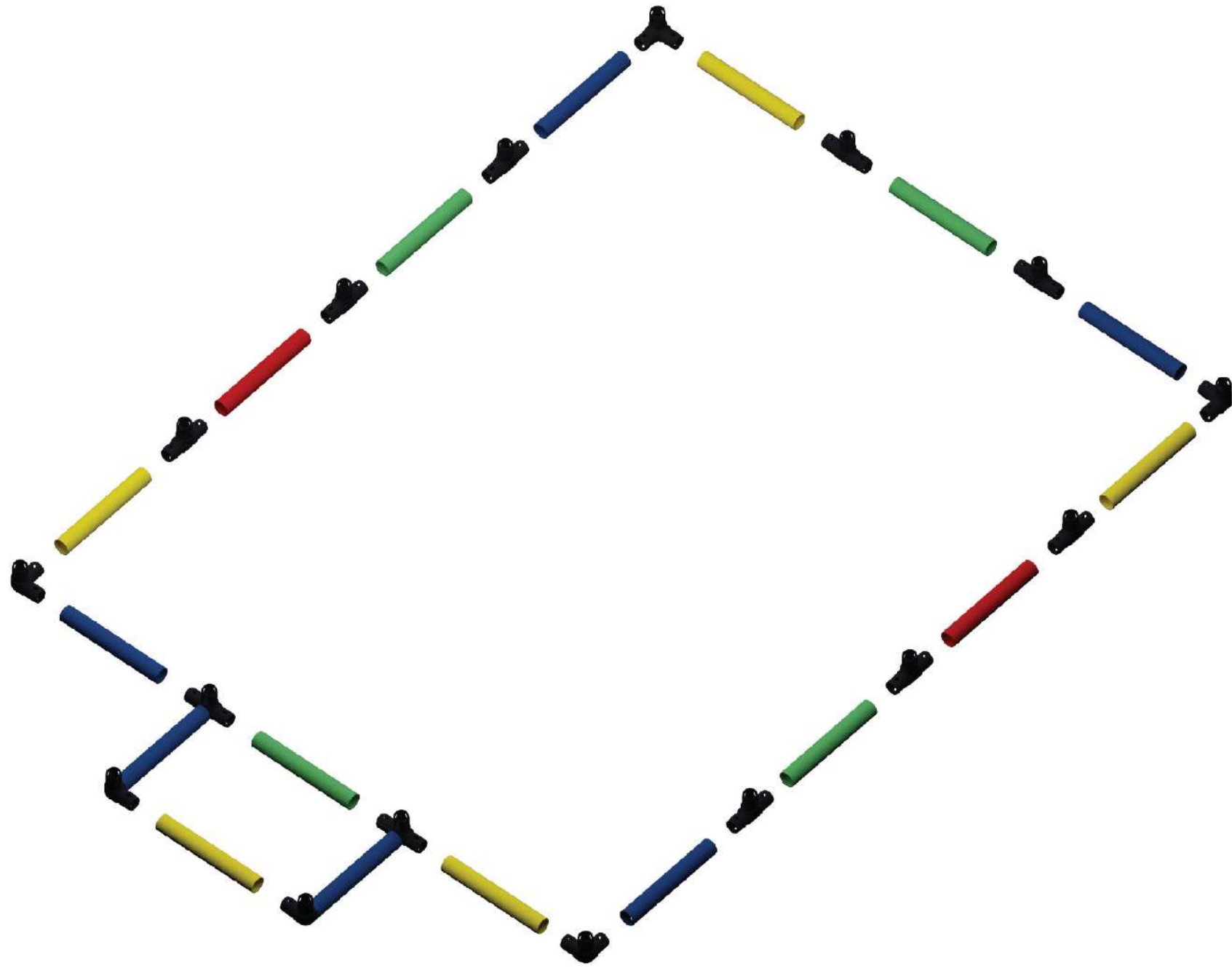

2

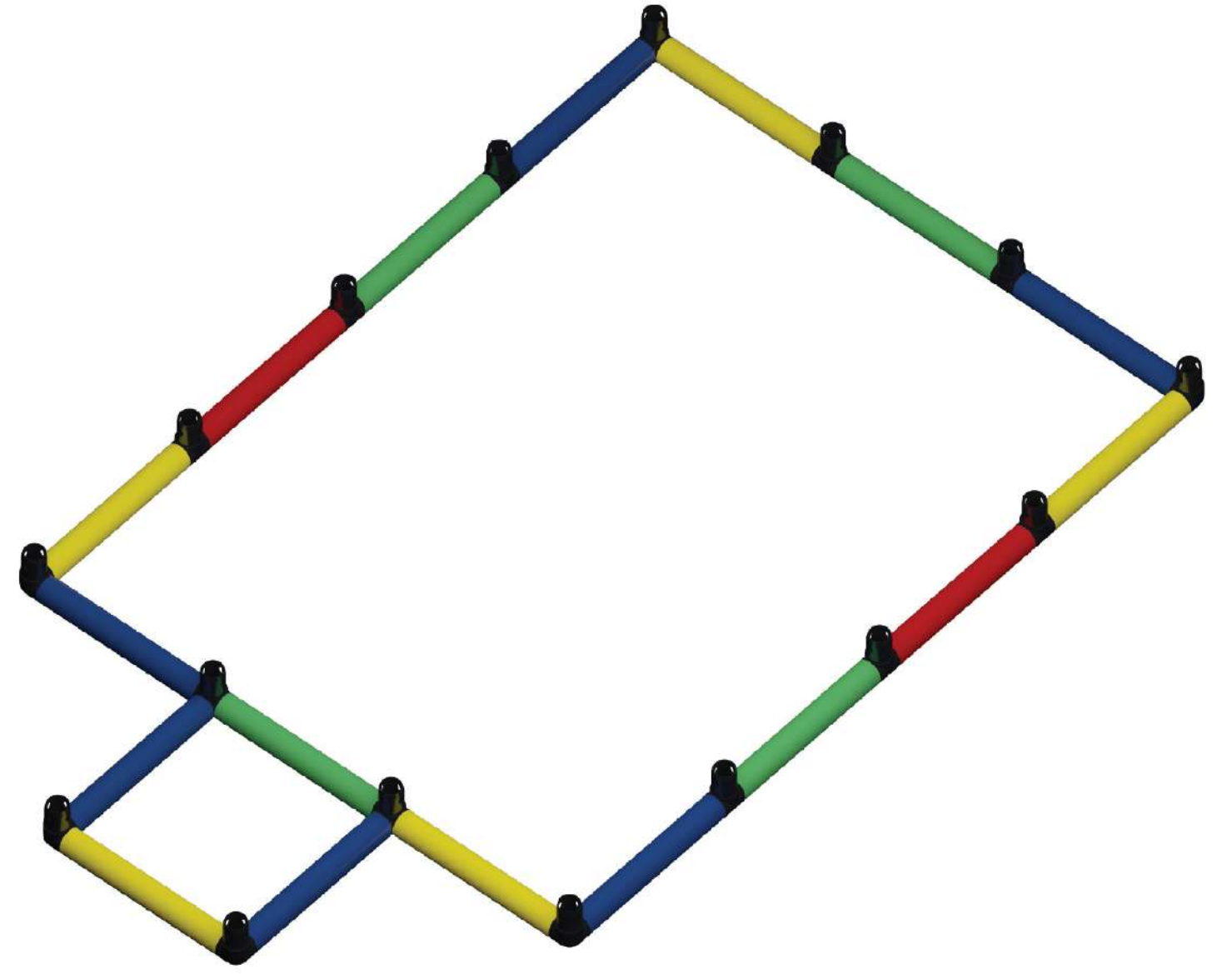

3

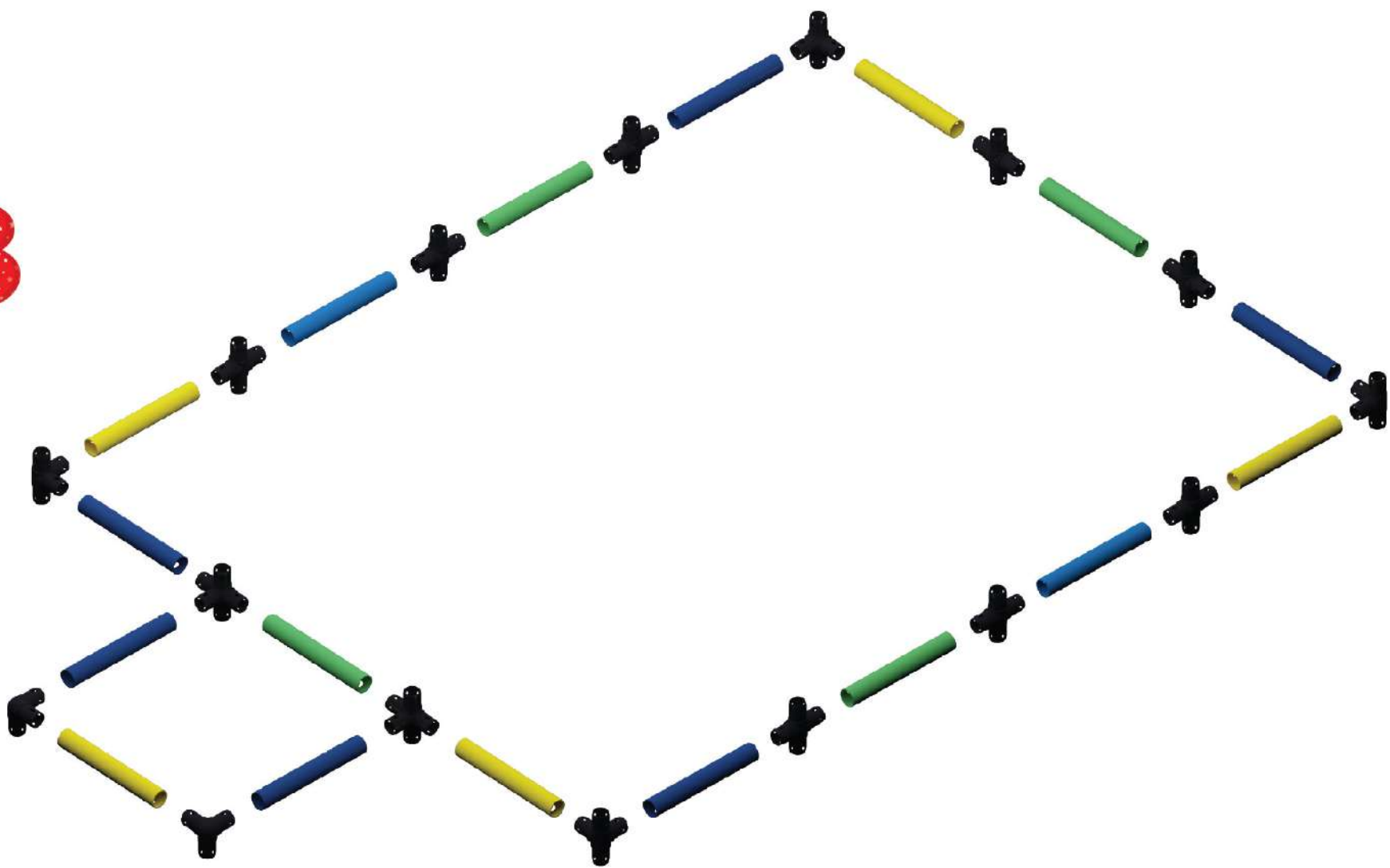

4

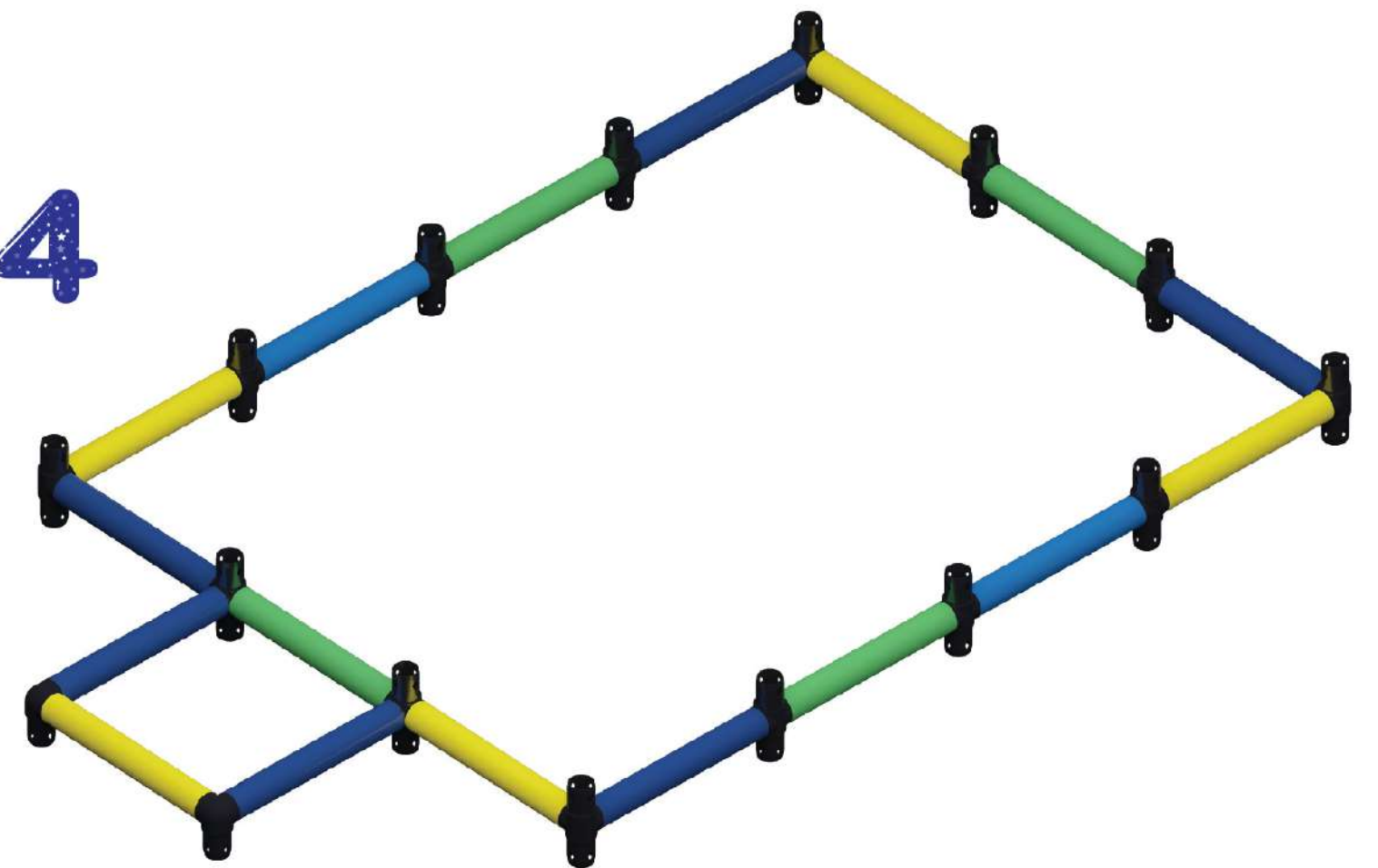

5

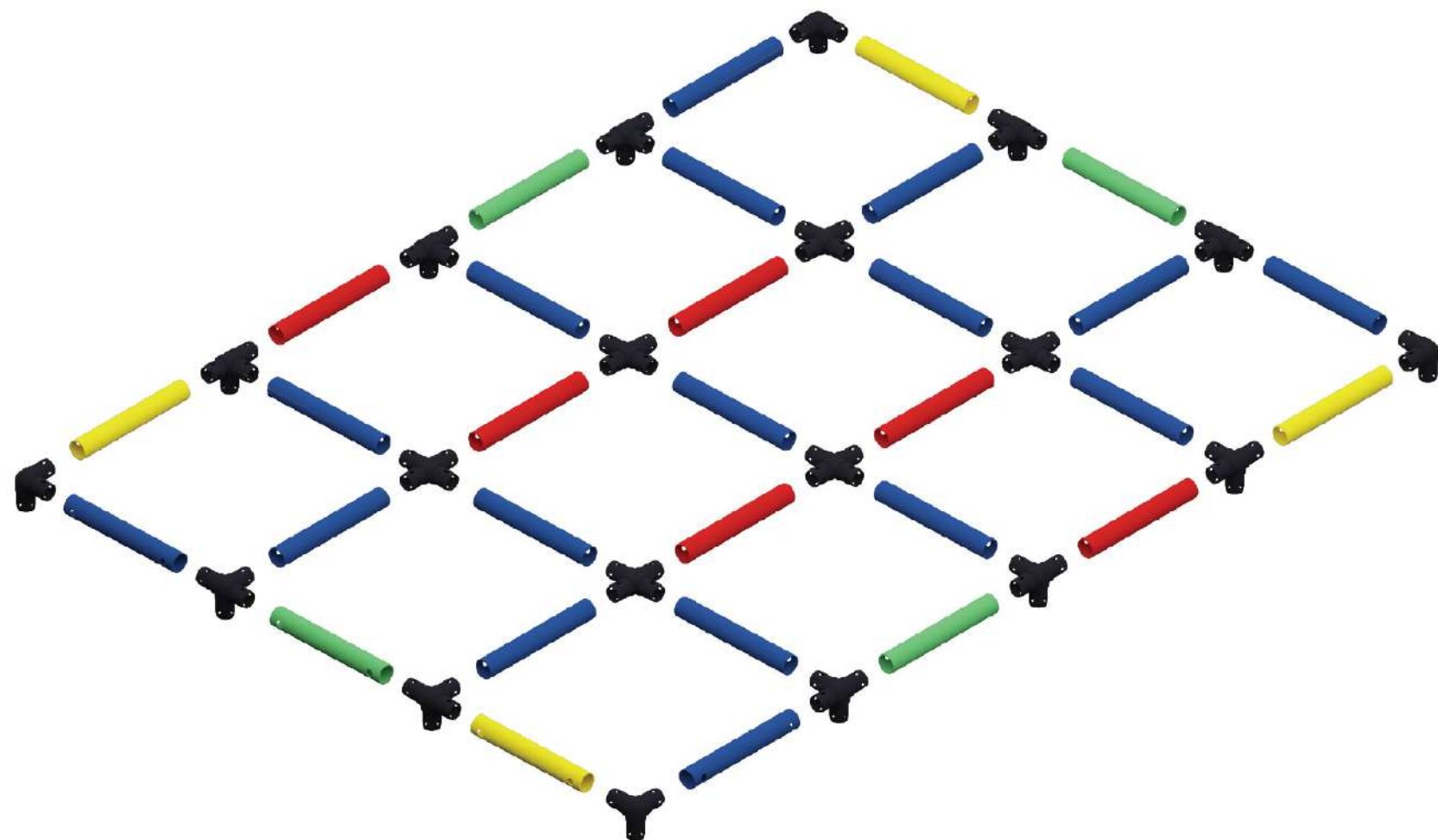

6

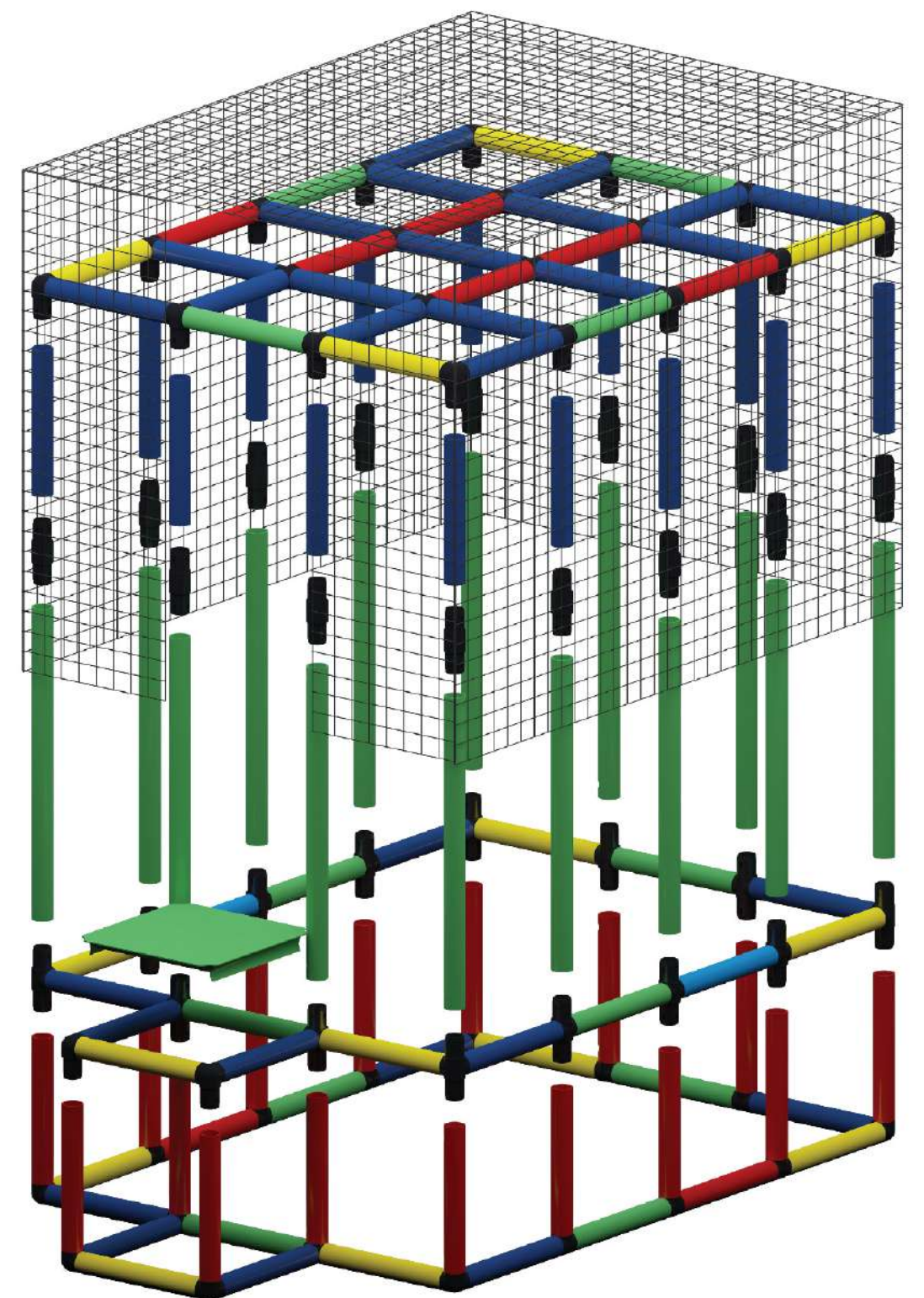

Insert Screws
and Secure all Screws



118x

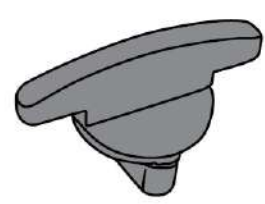

56x

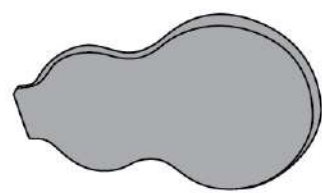

2x

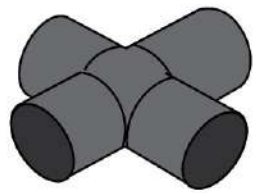

14x

Large Ball Pit

7

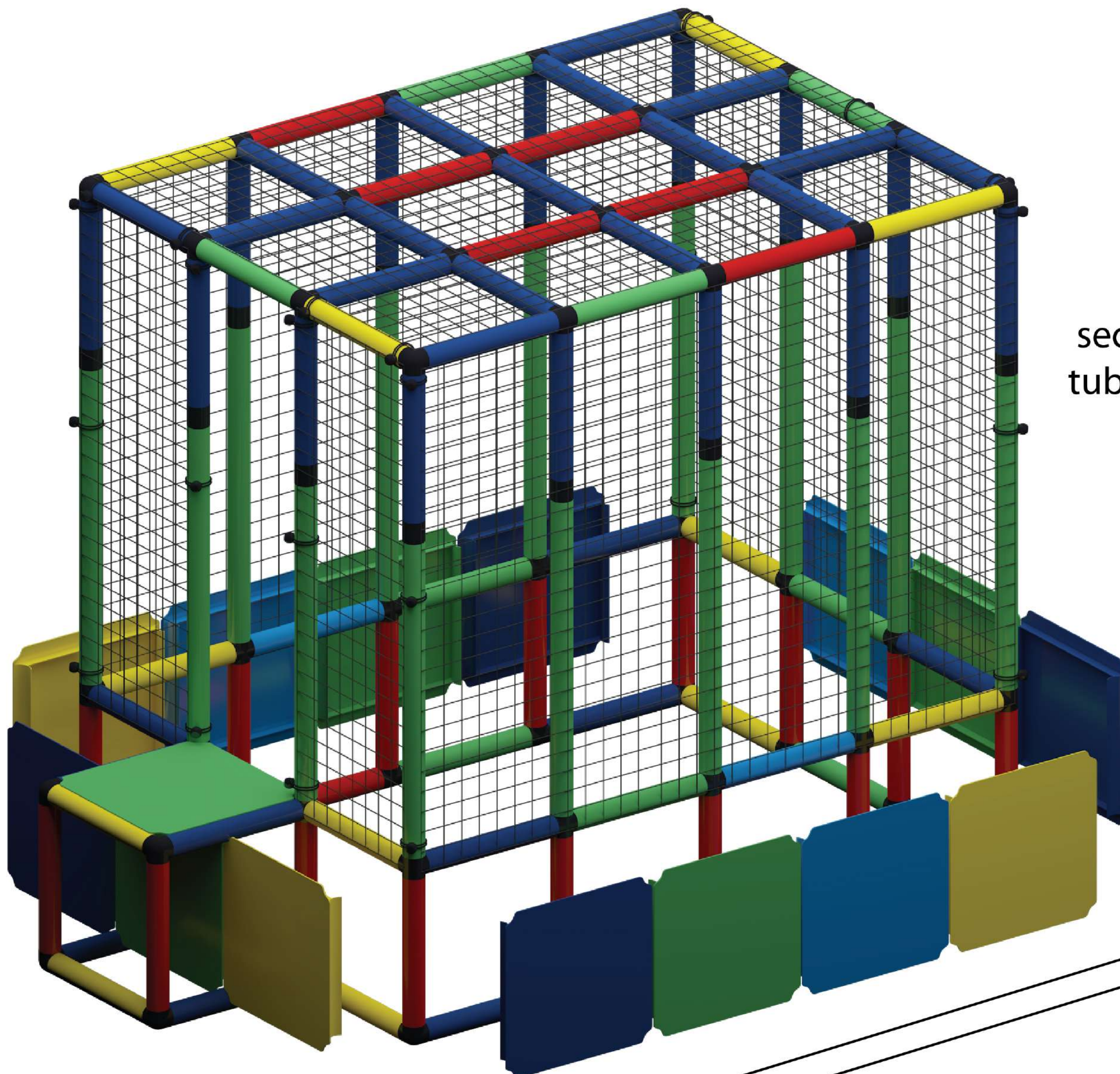

secure the net to the tubes with the bungee cords

8

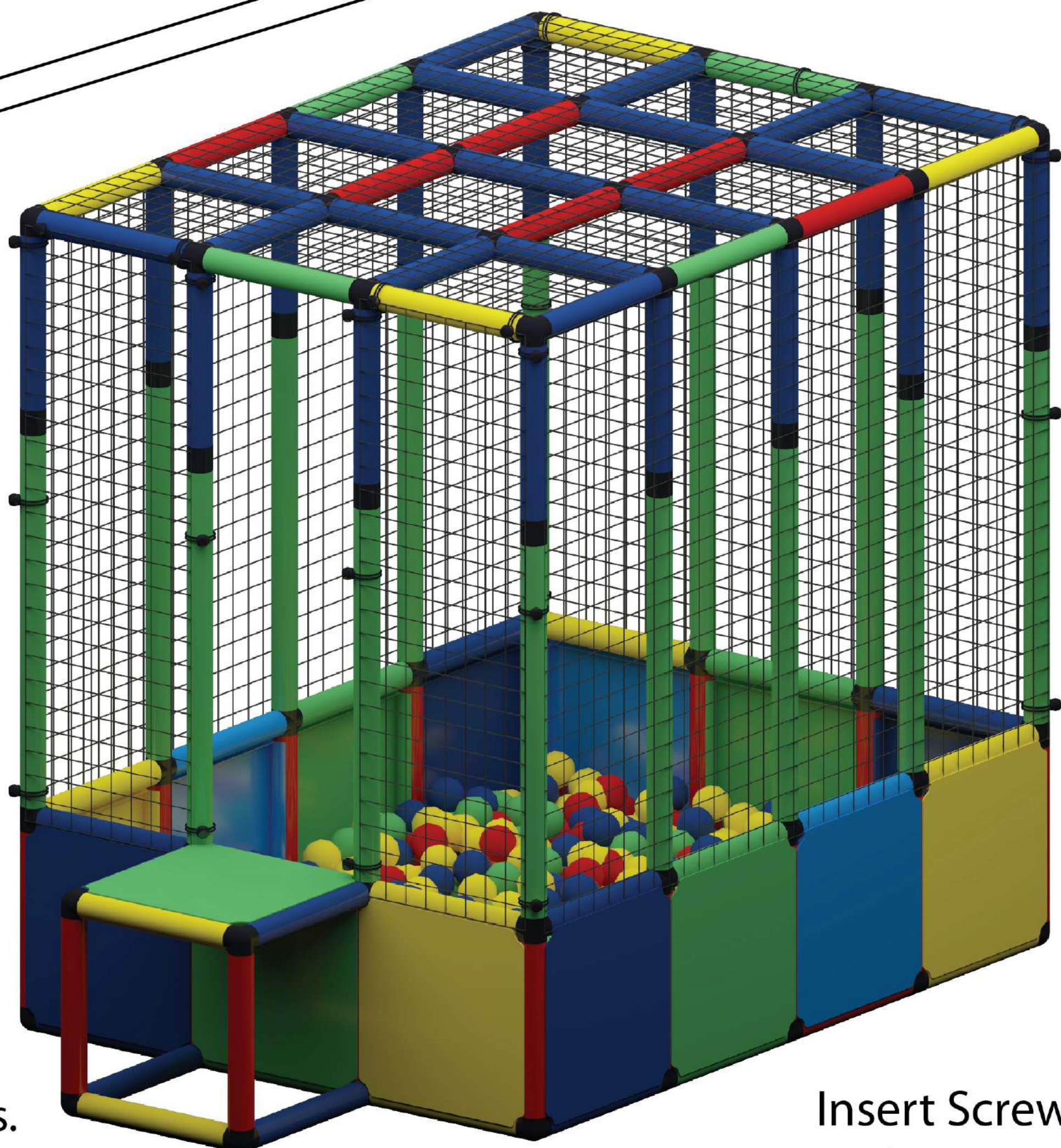

Ball have to be purchased separately.
Recommended quantity to fill up the Ball pit is 1400pcs 3 inches Balls.

Insert Screws and Secure all Screws

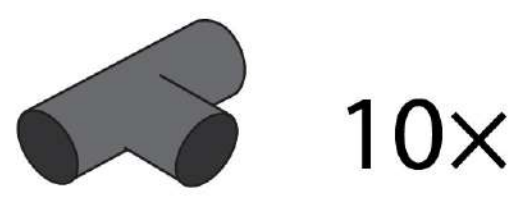

10x

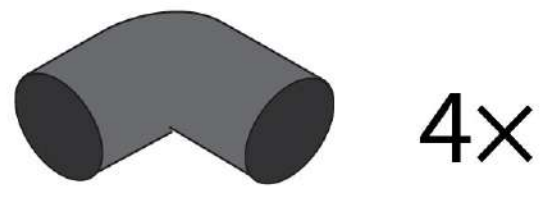

4x



59x

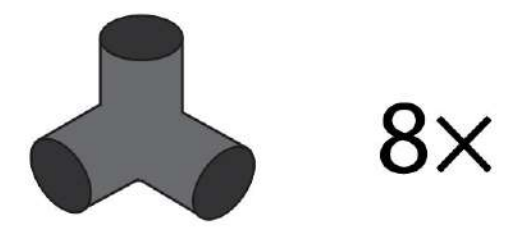

8x

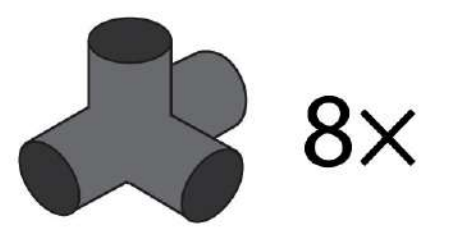

8x

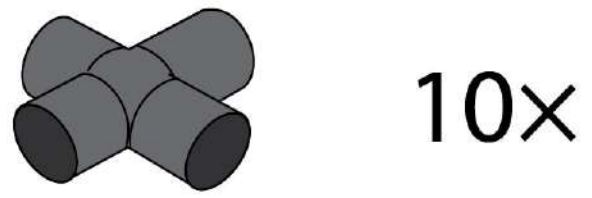

10x

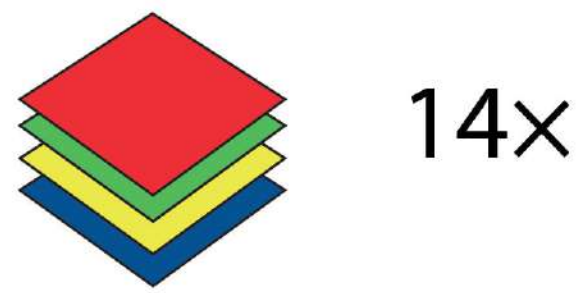

14x



118x

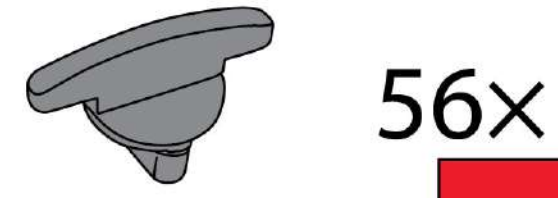

56x

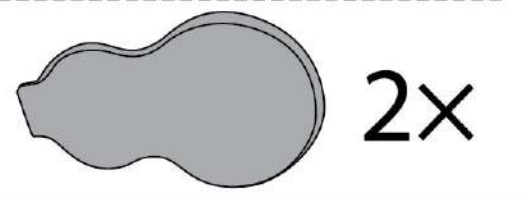

2x

Med Ball Pit

1

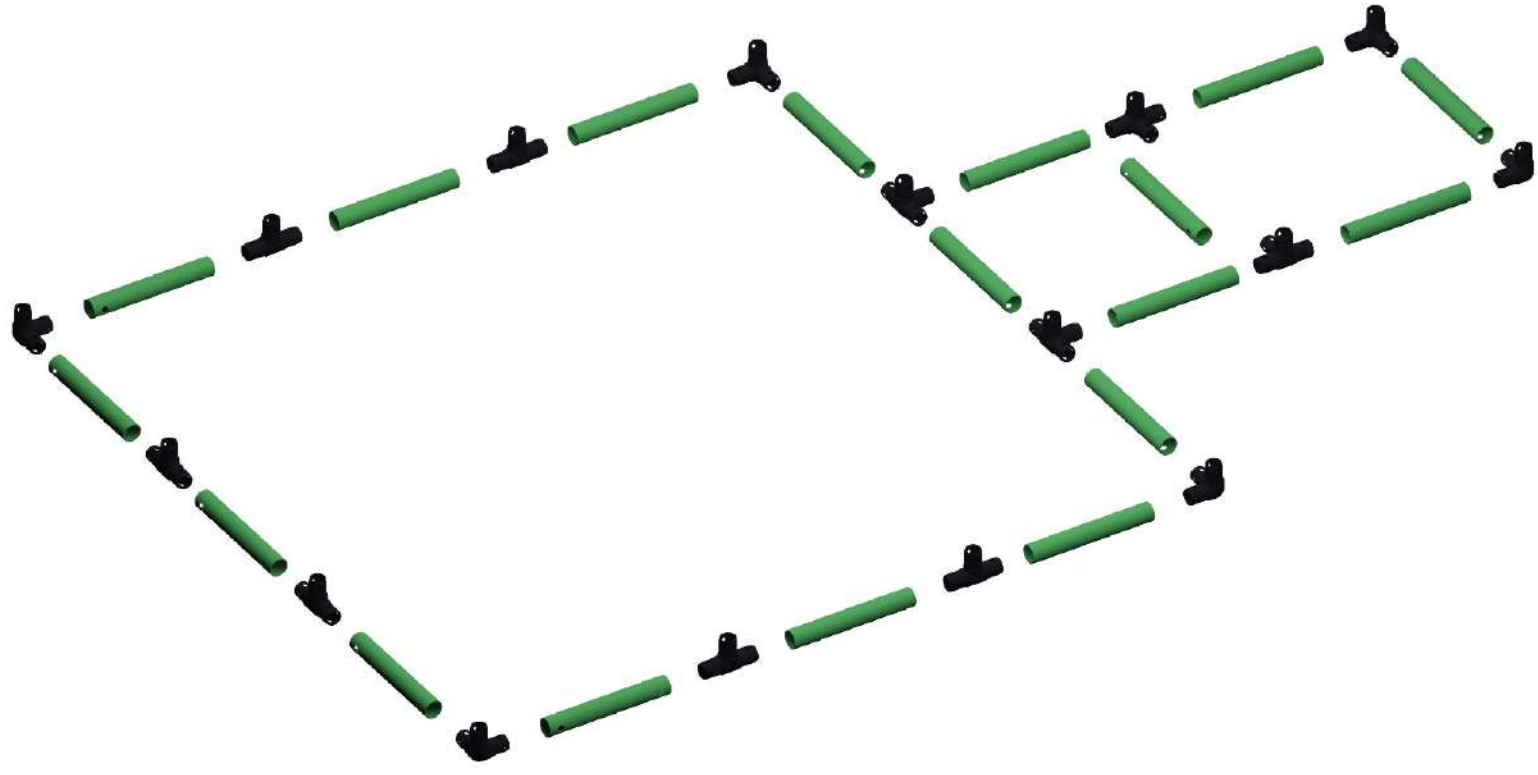

2

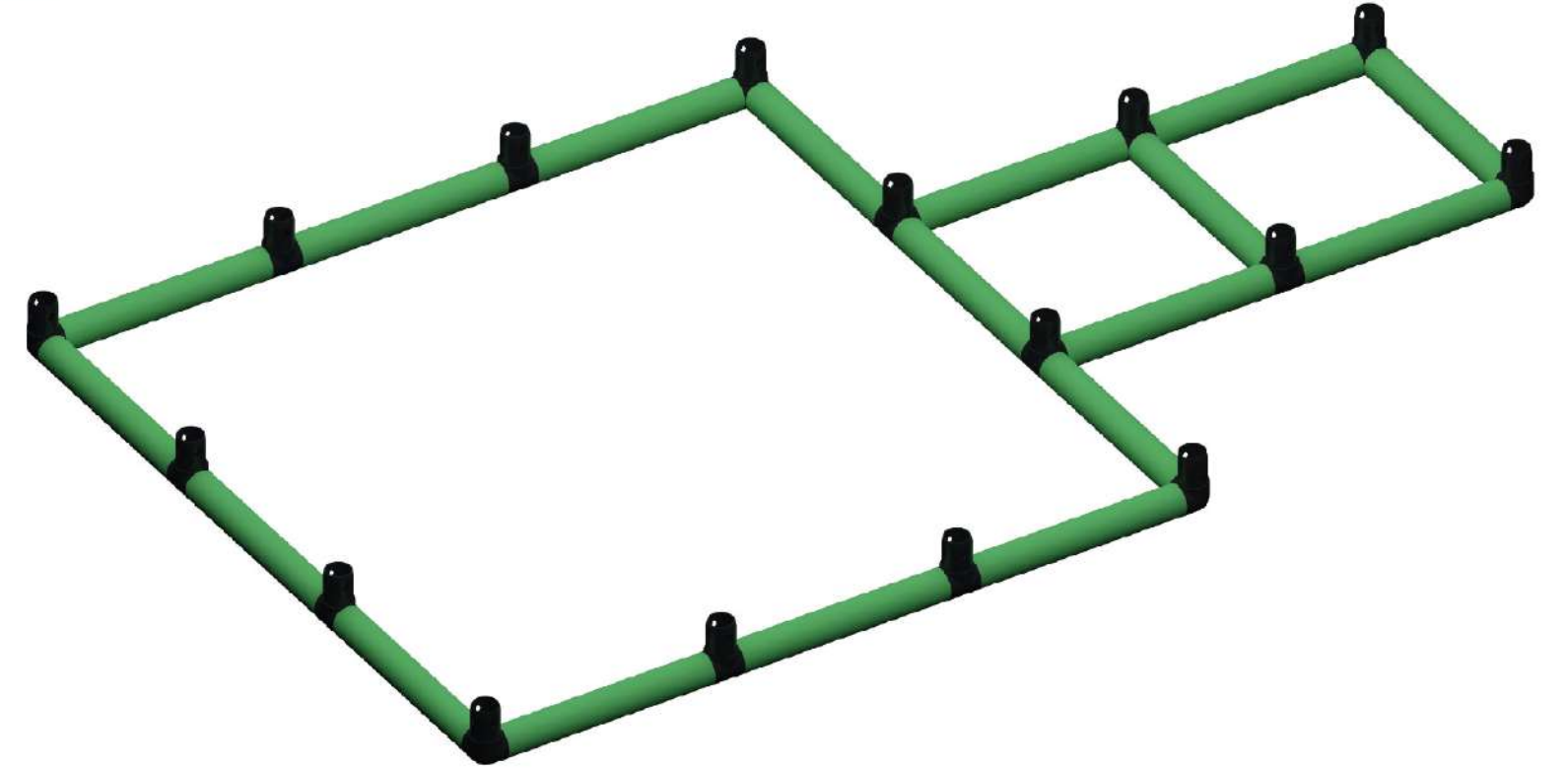

3

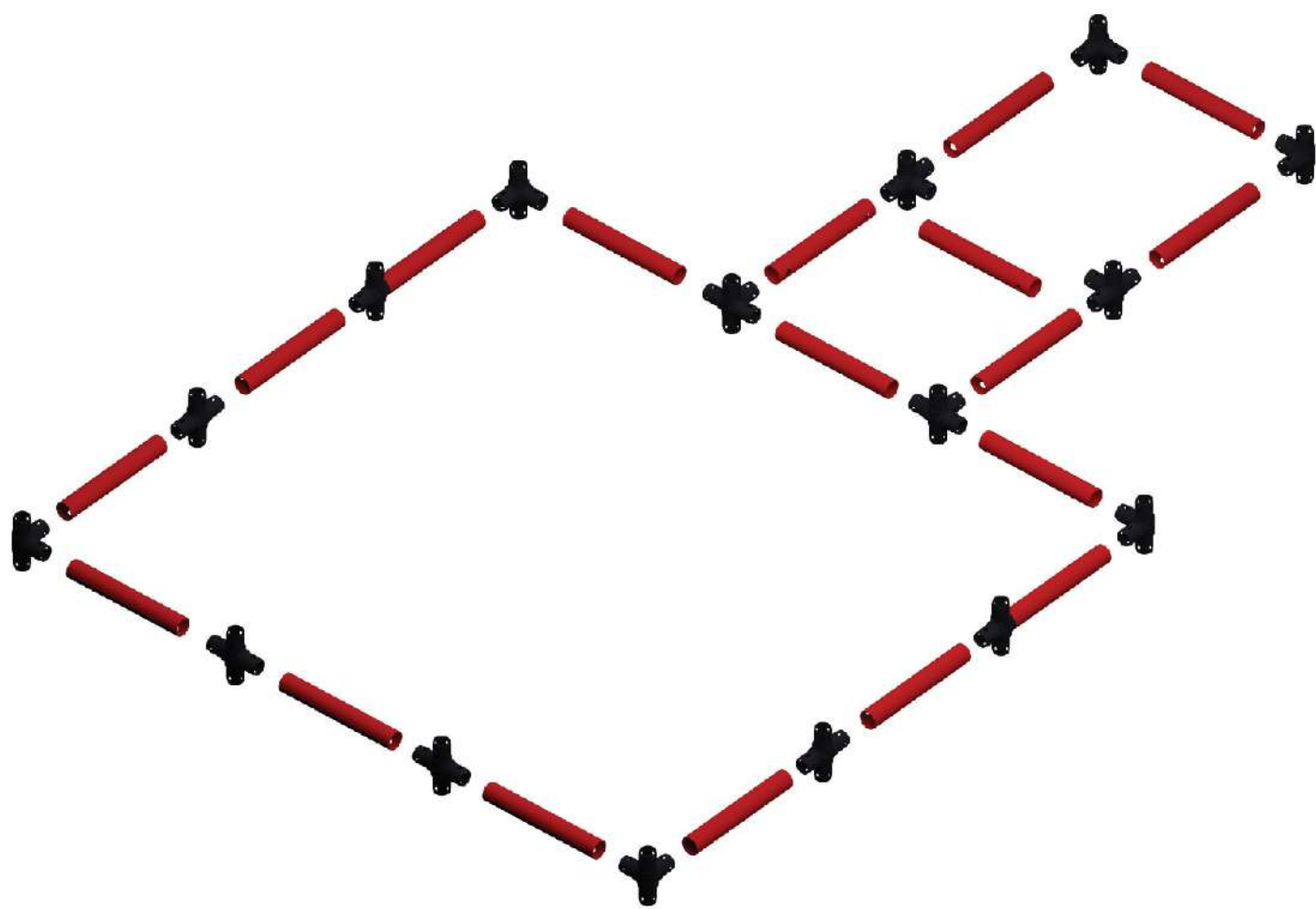

4

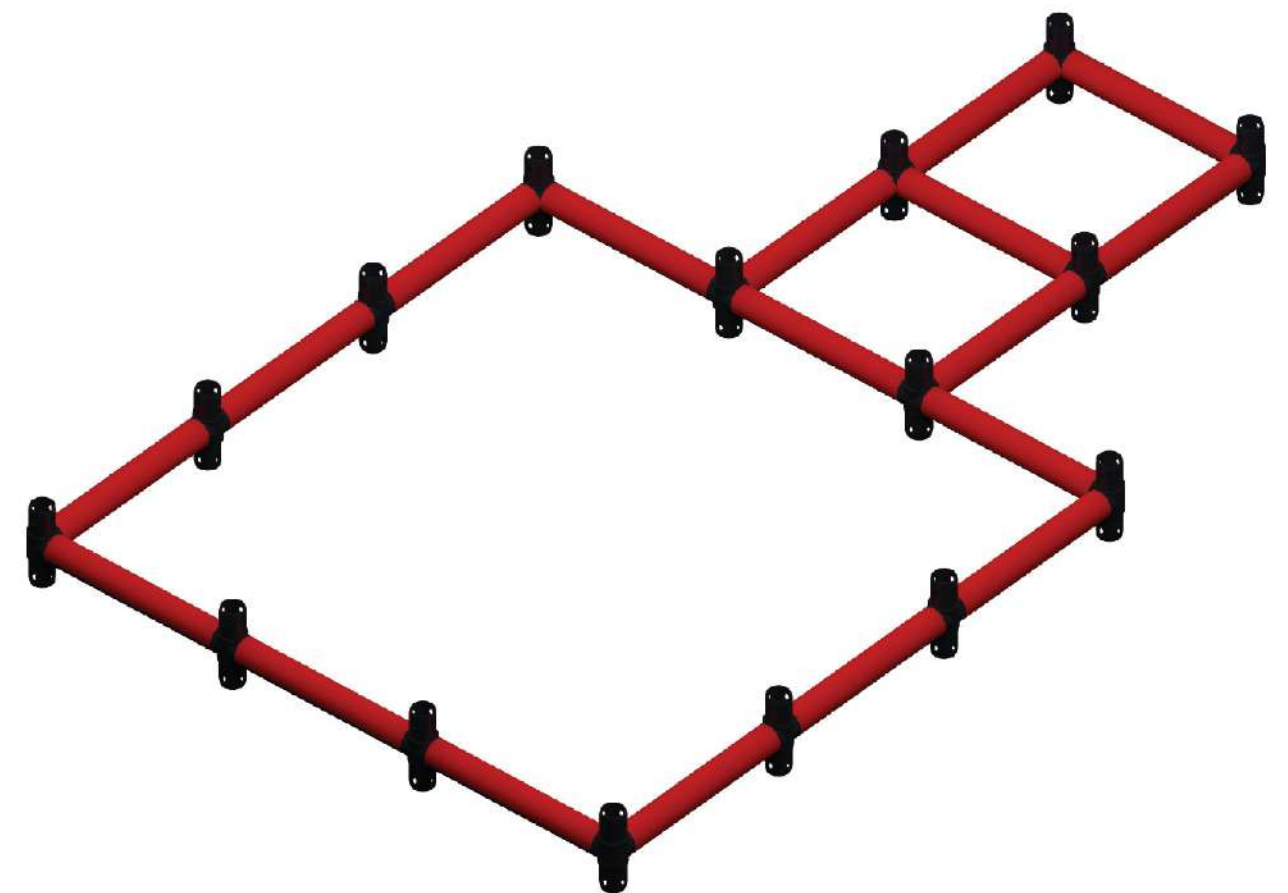

5

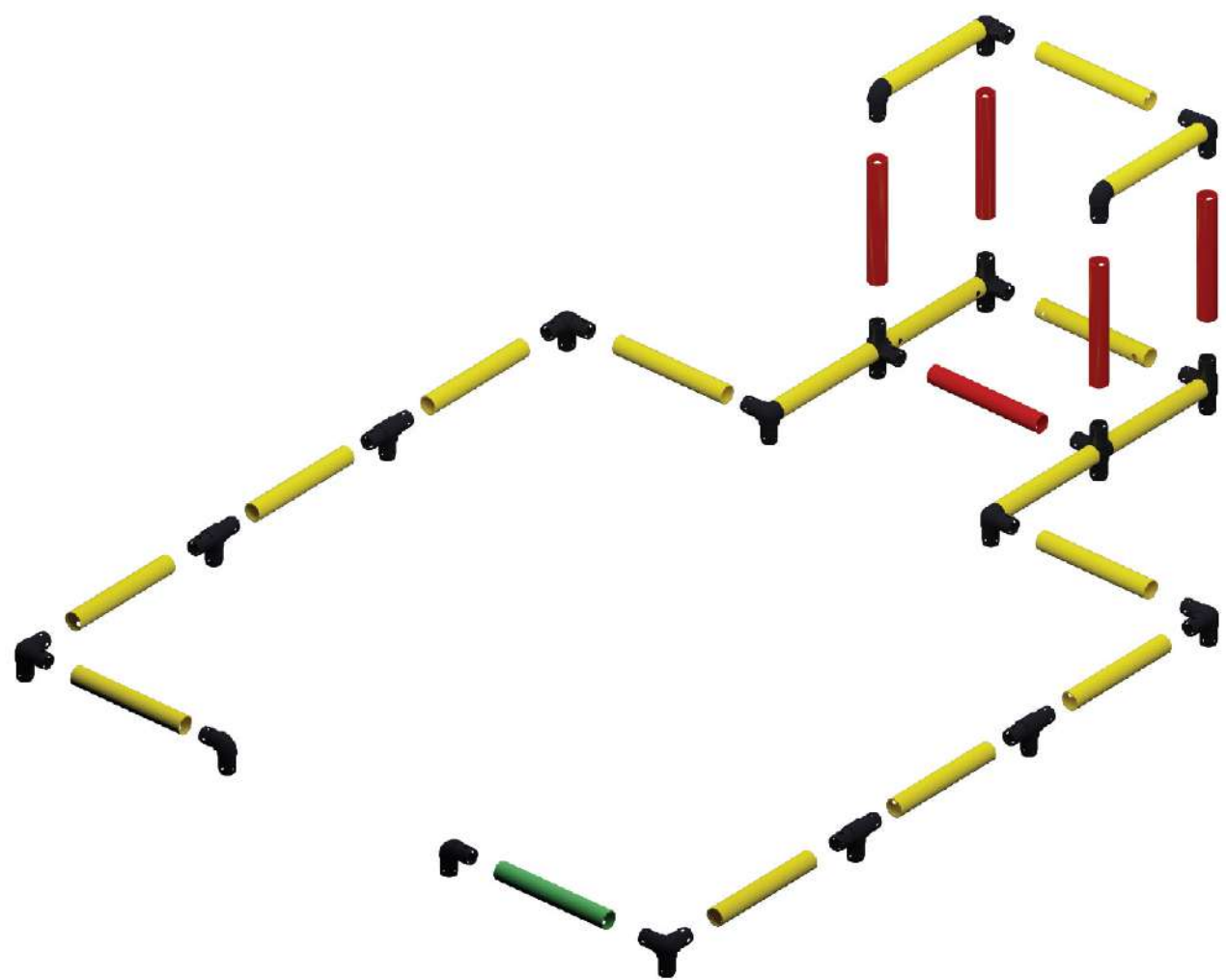

6

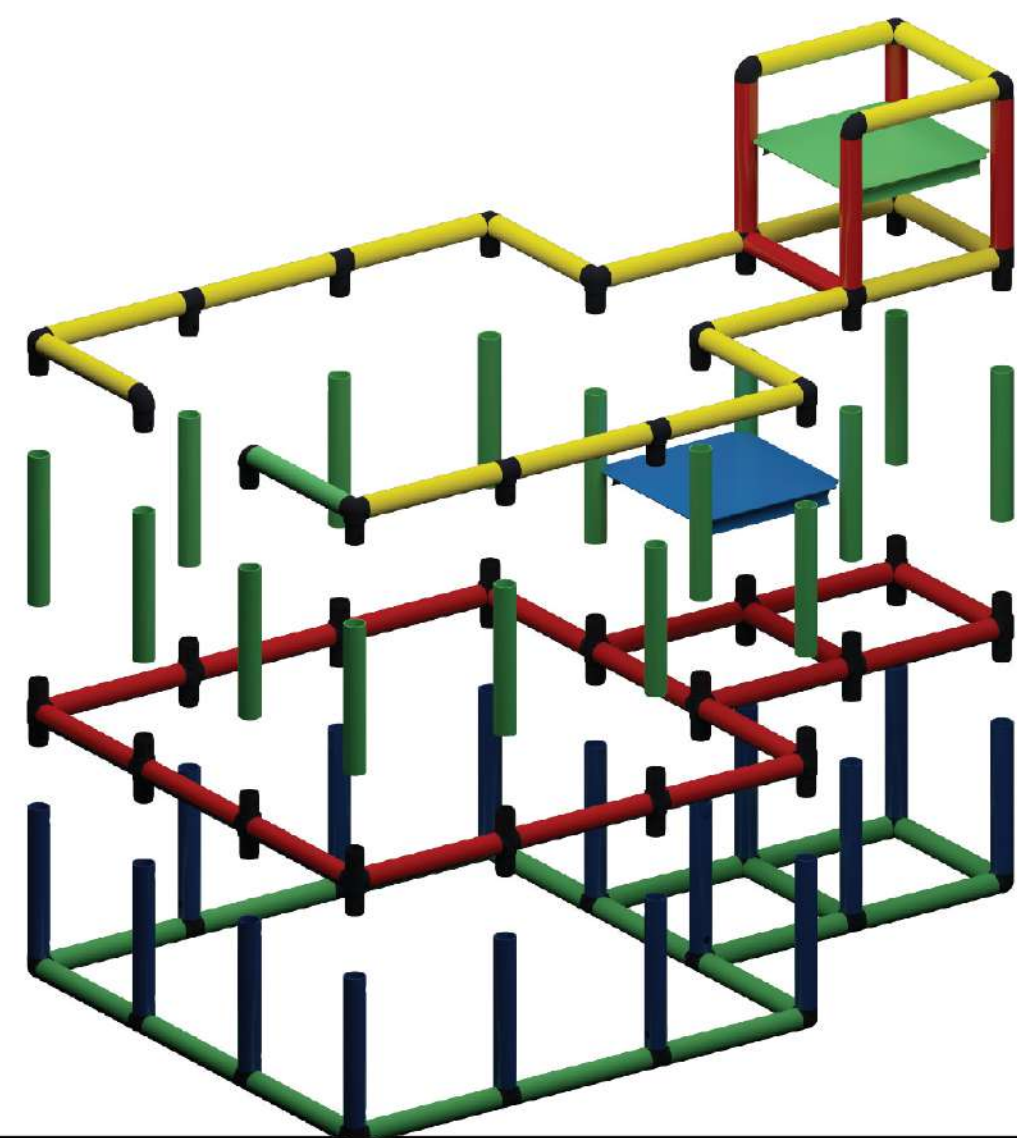

7

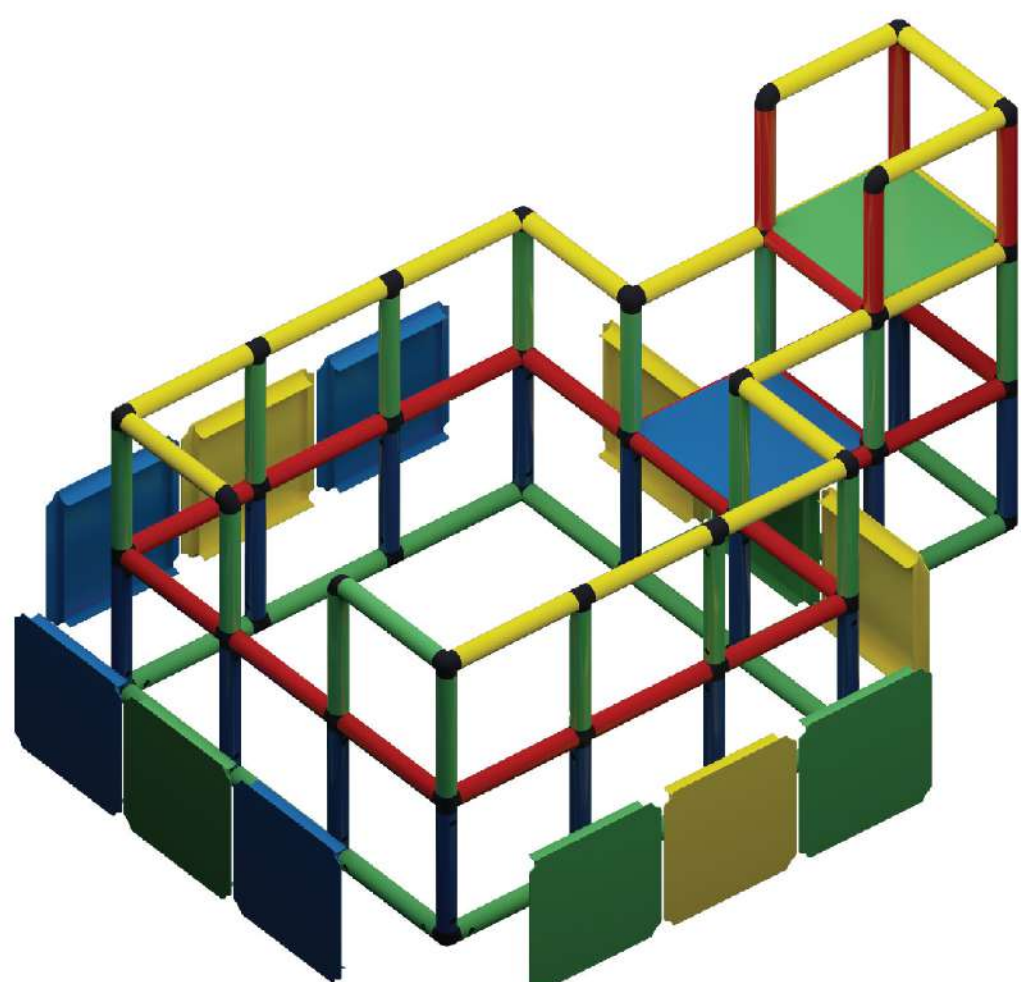

8

Ball have to be purchased separately. Recommended quantity to fill up the Ball pit is 1200pcs 3 inches Balls.

Insert Screws and Secure all Screws

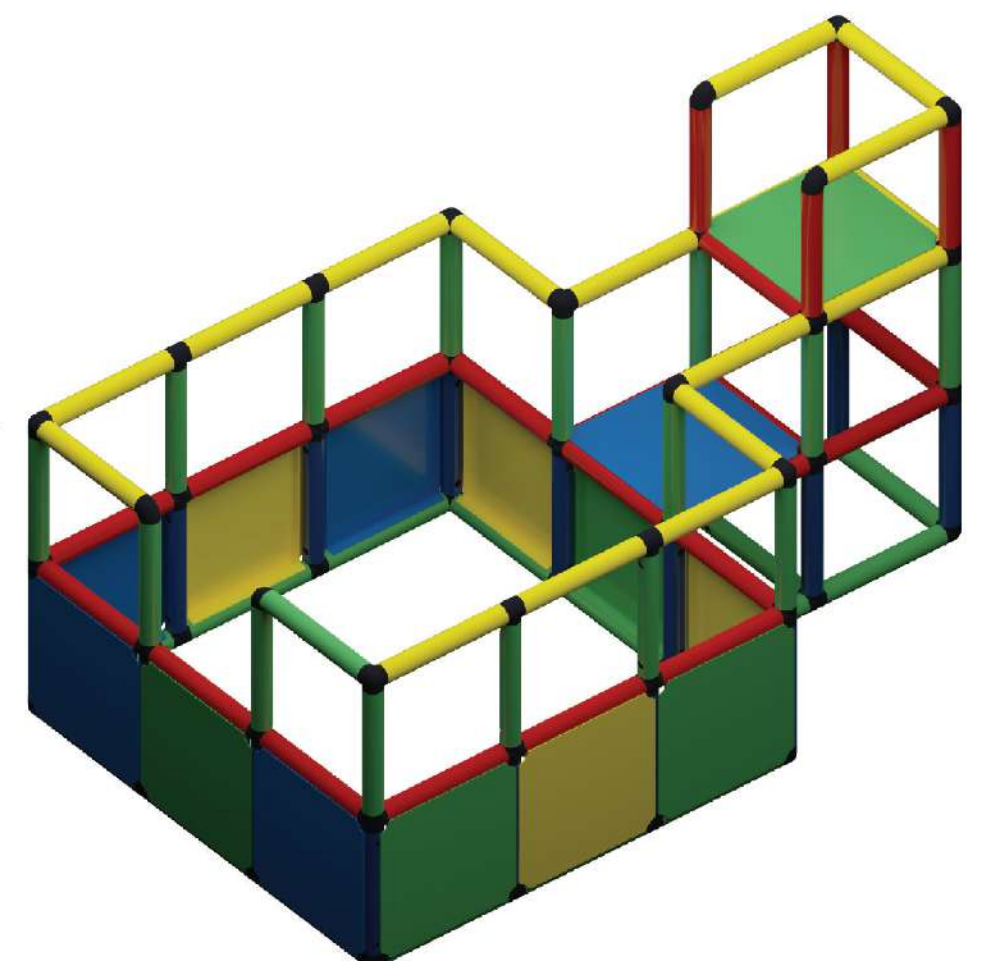

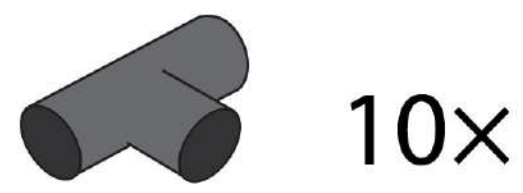

10x

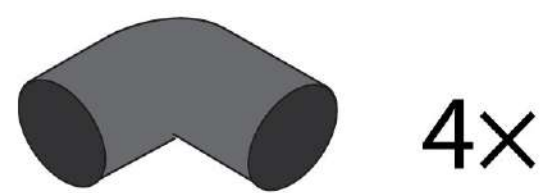

4x

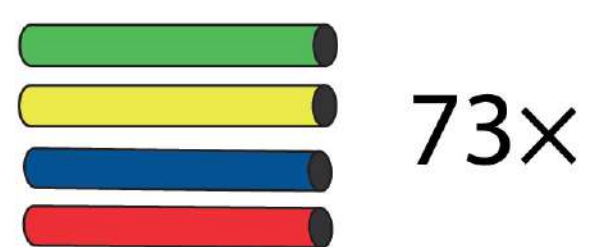

73x

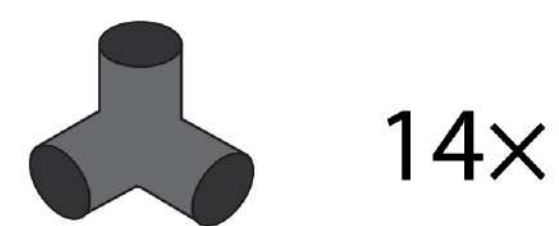

14x

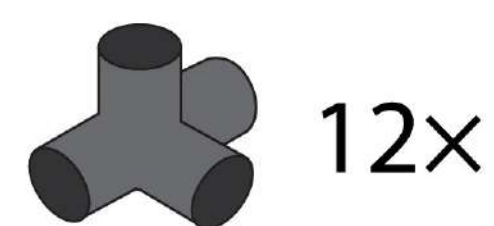

12x

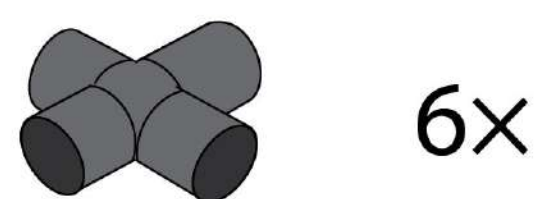

6x

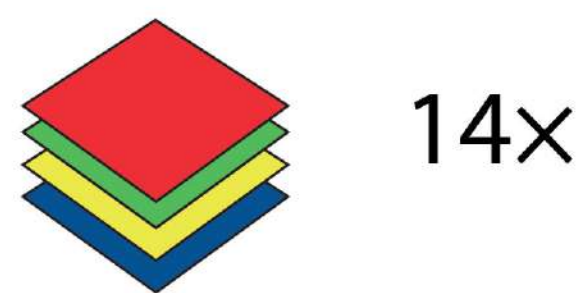

14x

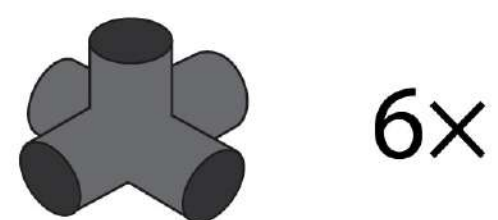

6x



118x



56x

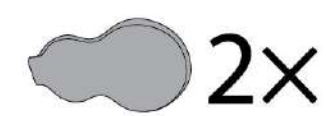

2x

Starter Ball Pit

1



2

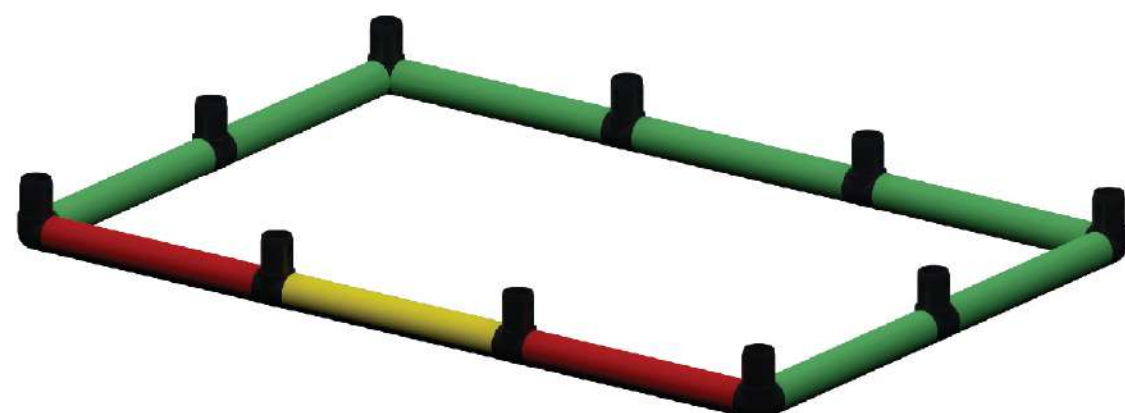

3

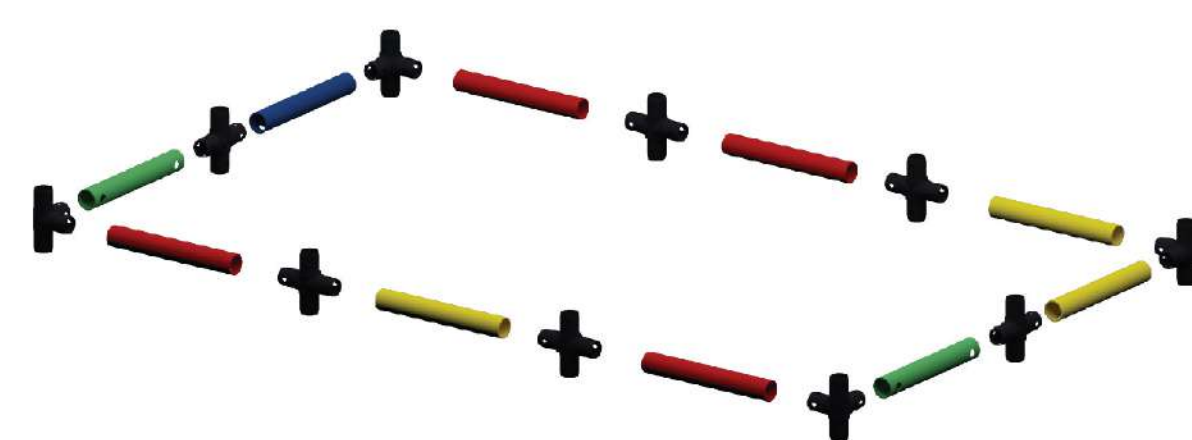

4



5

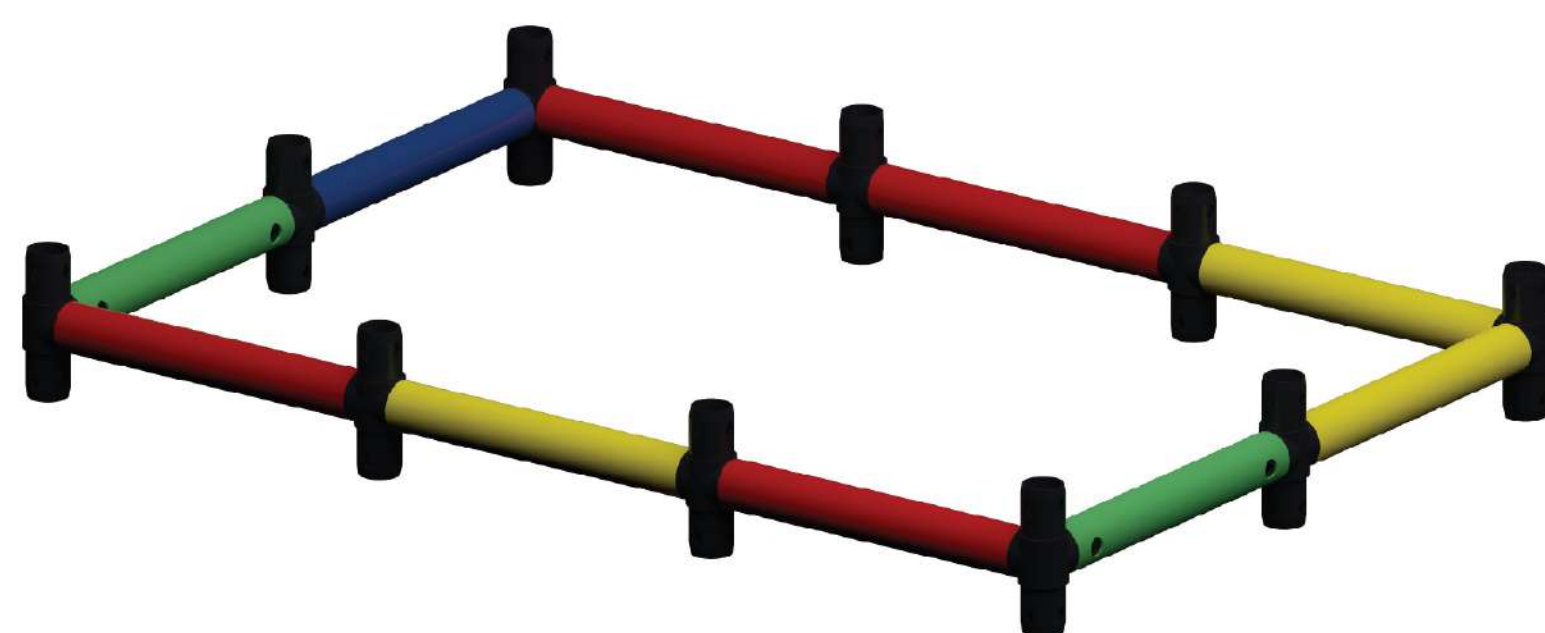

6

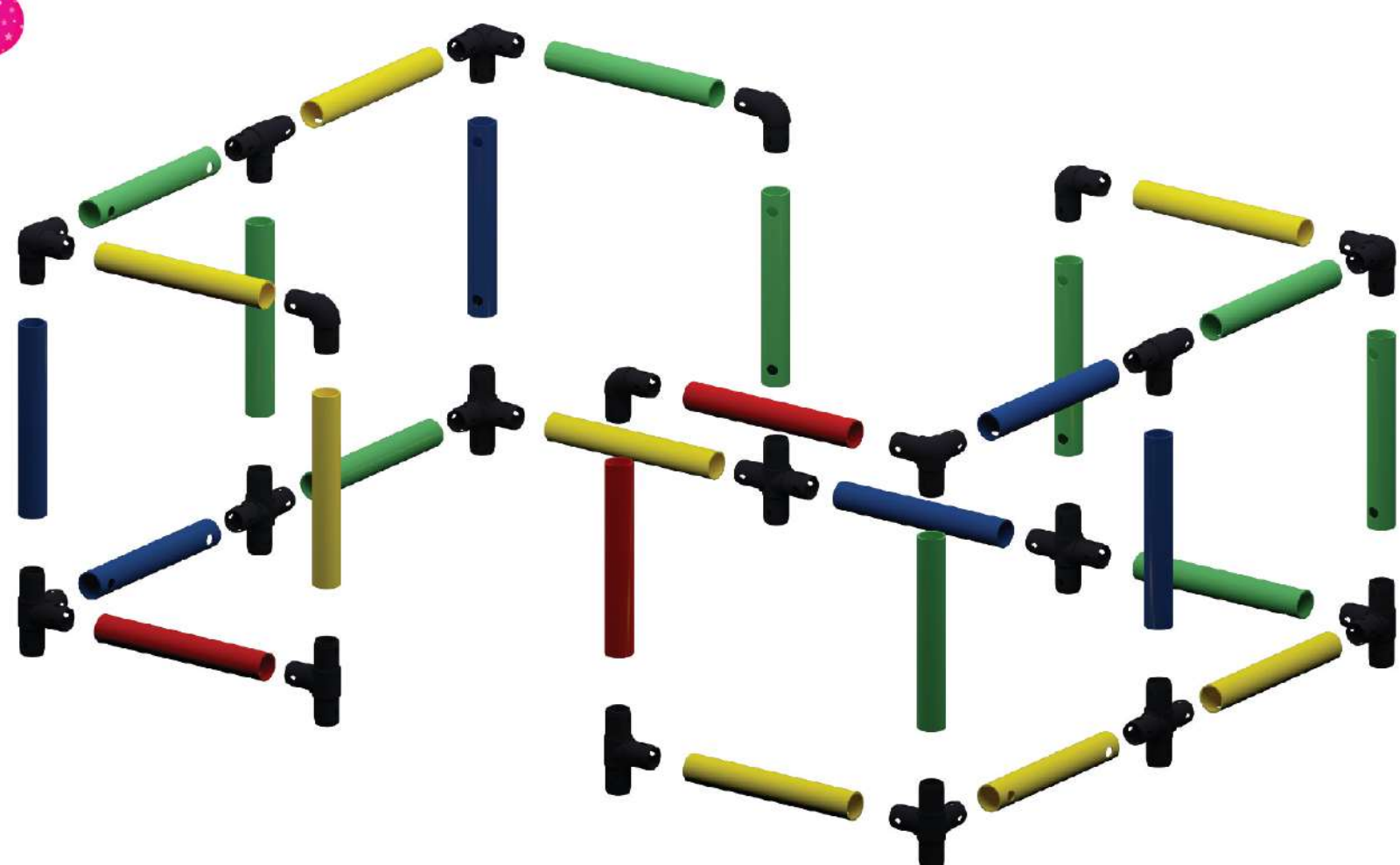

7

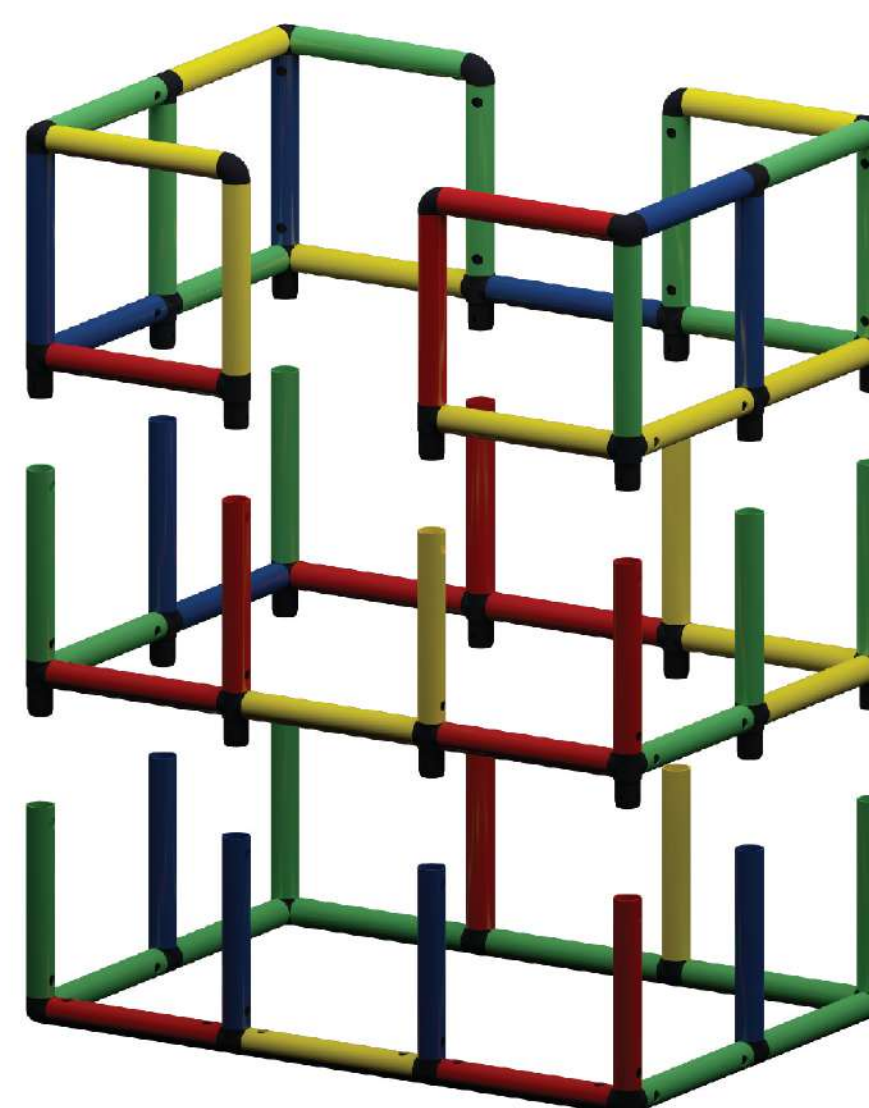

8

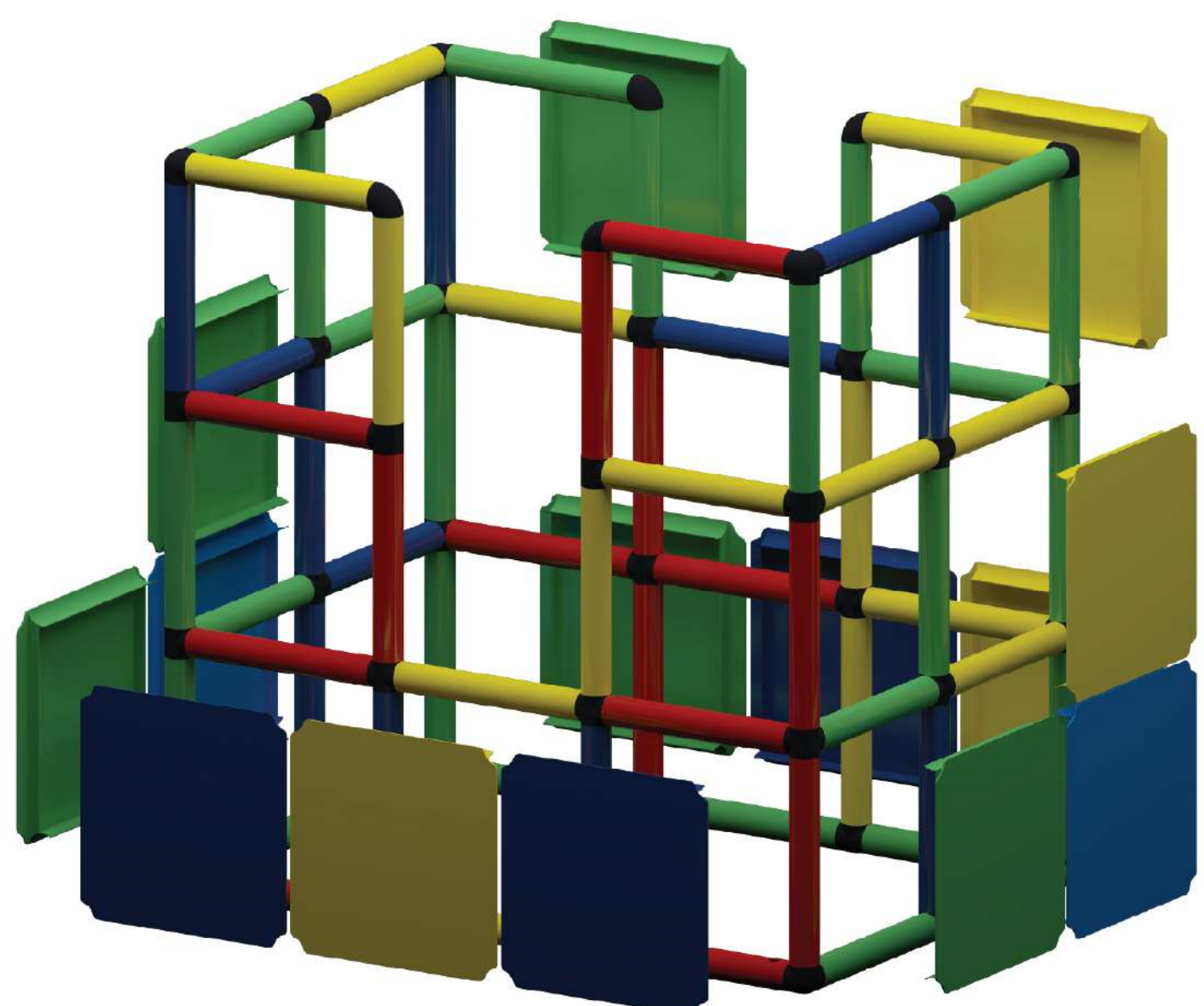

9

Ball have to be purchased separately. Recommended quantity to fill up the Ball pit is 1000pcs 3 inches Balls.

Insert Screws and Secure all Screws



Warranty

It is our ultimate goal to serve our happy customers.

Funphix provides

5 Year warranty on Funphix parts when used indoors.

3 year warranty on Funphix parts when structures has been used or stored outdoors for greater than 3 months.

Dear kids,

The team at funphix is excited to see you creating your own play structures. Send us a picture or video of your play structure which you self-designed or built from the manual. We will consider posting it on our gallery. Send the image to mystructure@funphix.com

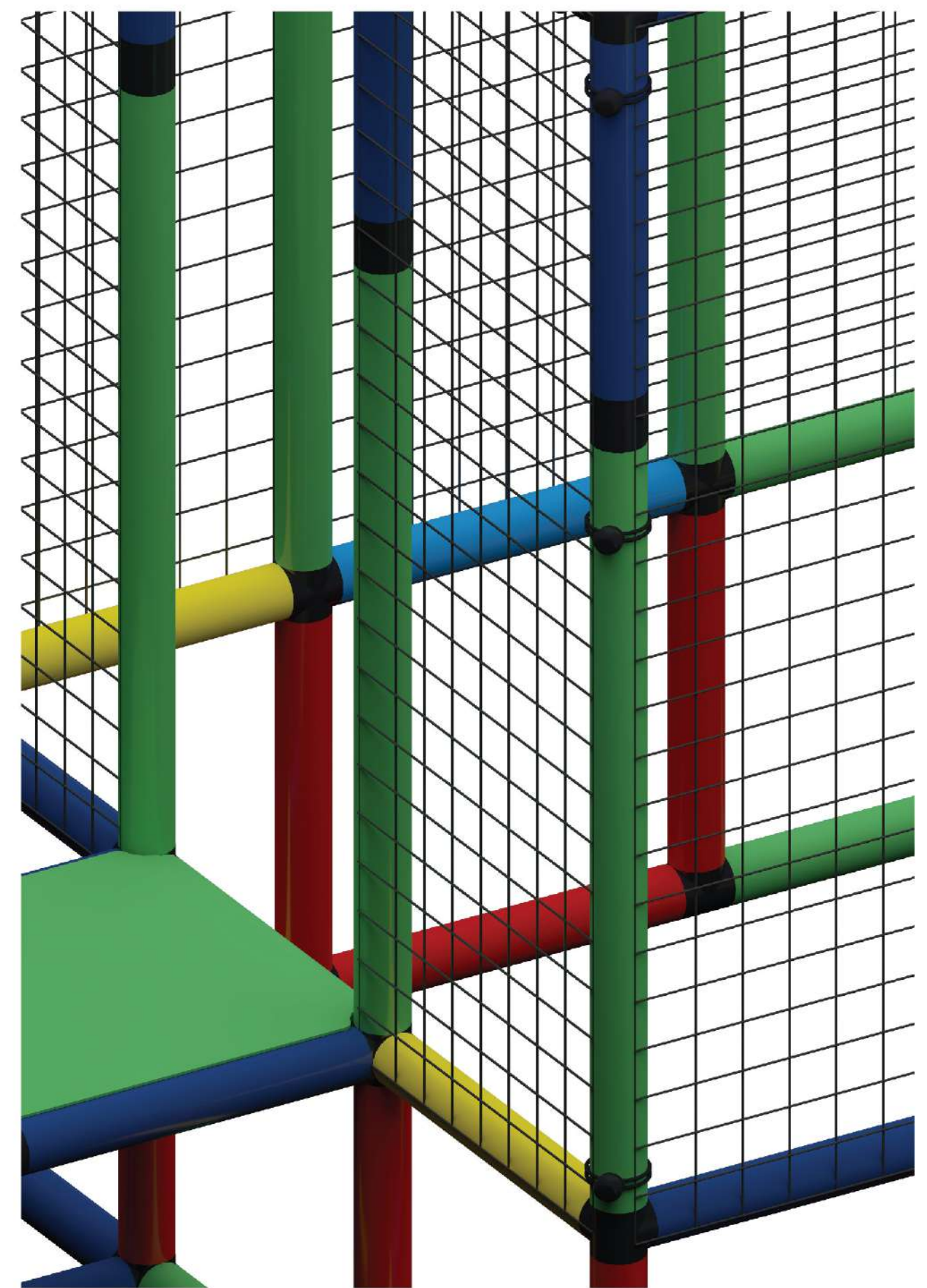
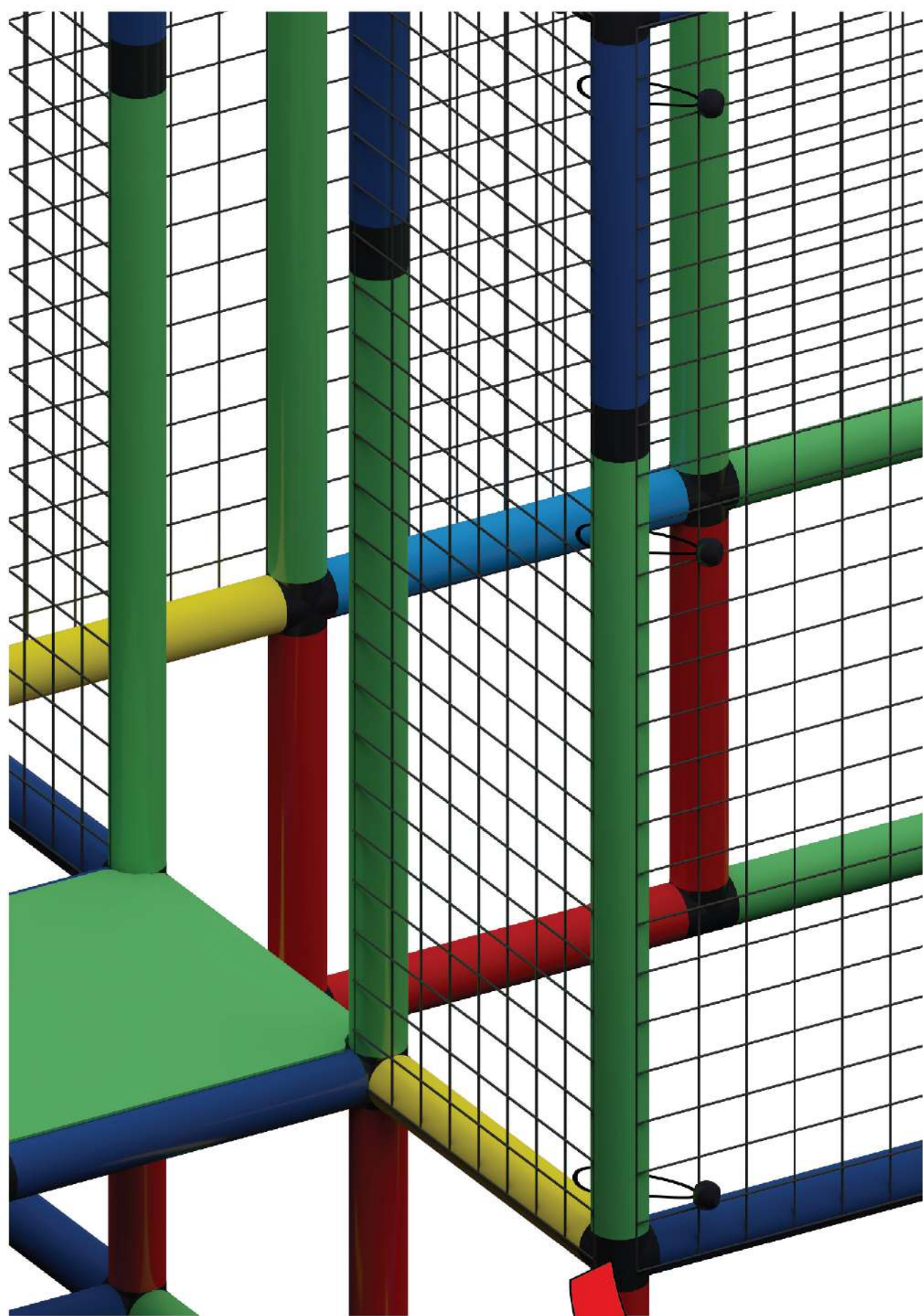

Please use the bungee cords to tie net with tubes.

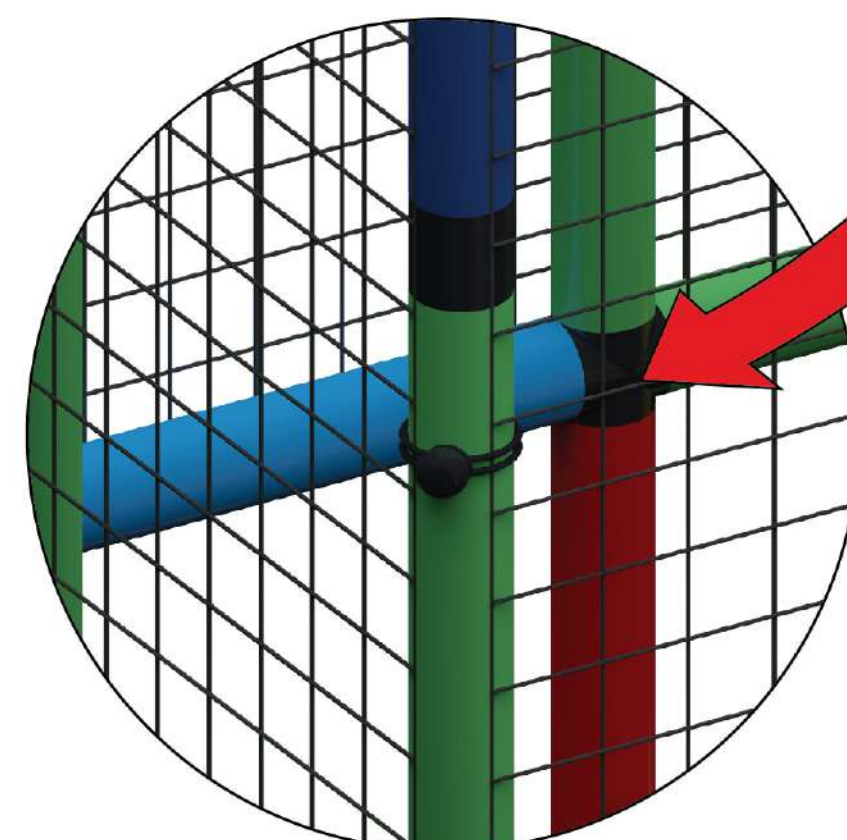
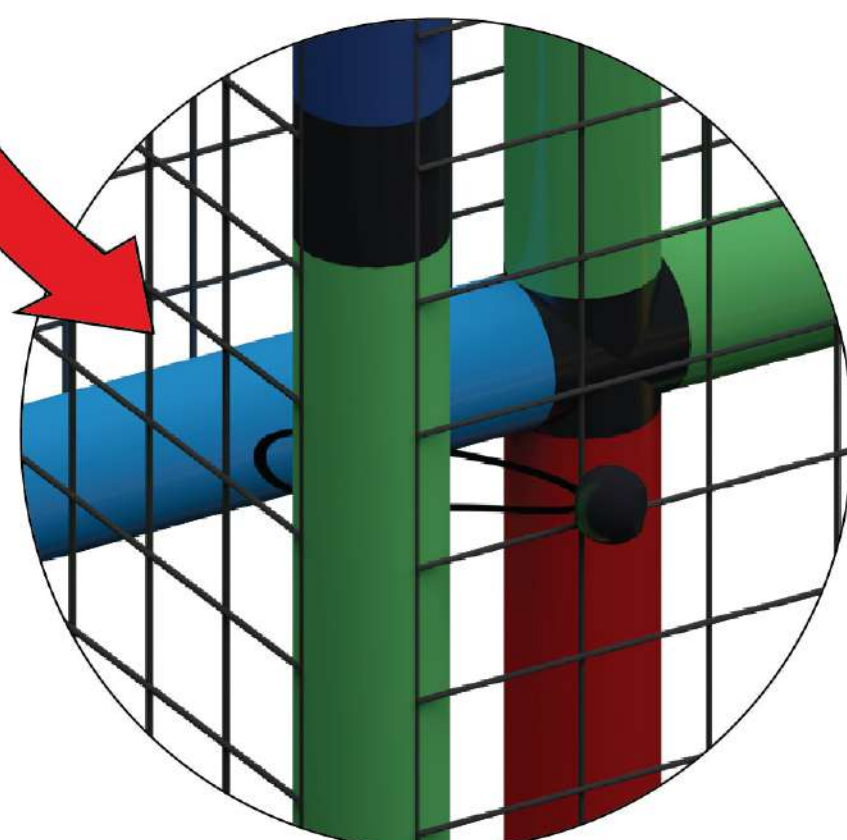

Meet the Funphix Family! Collect them all!

CLASSIC SET

FPCS-2

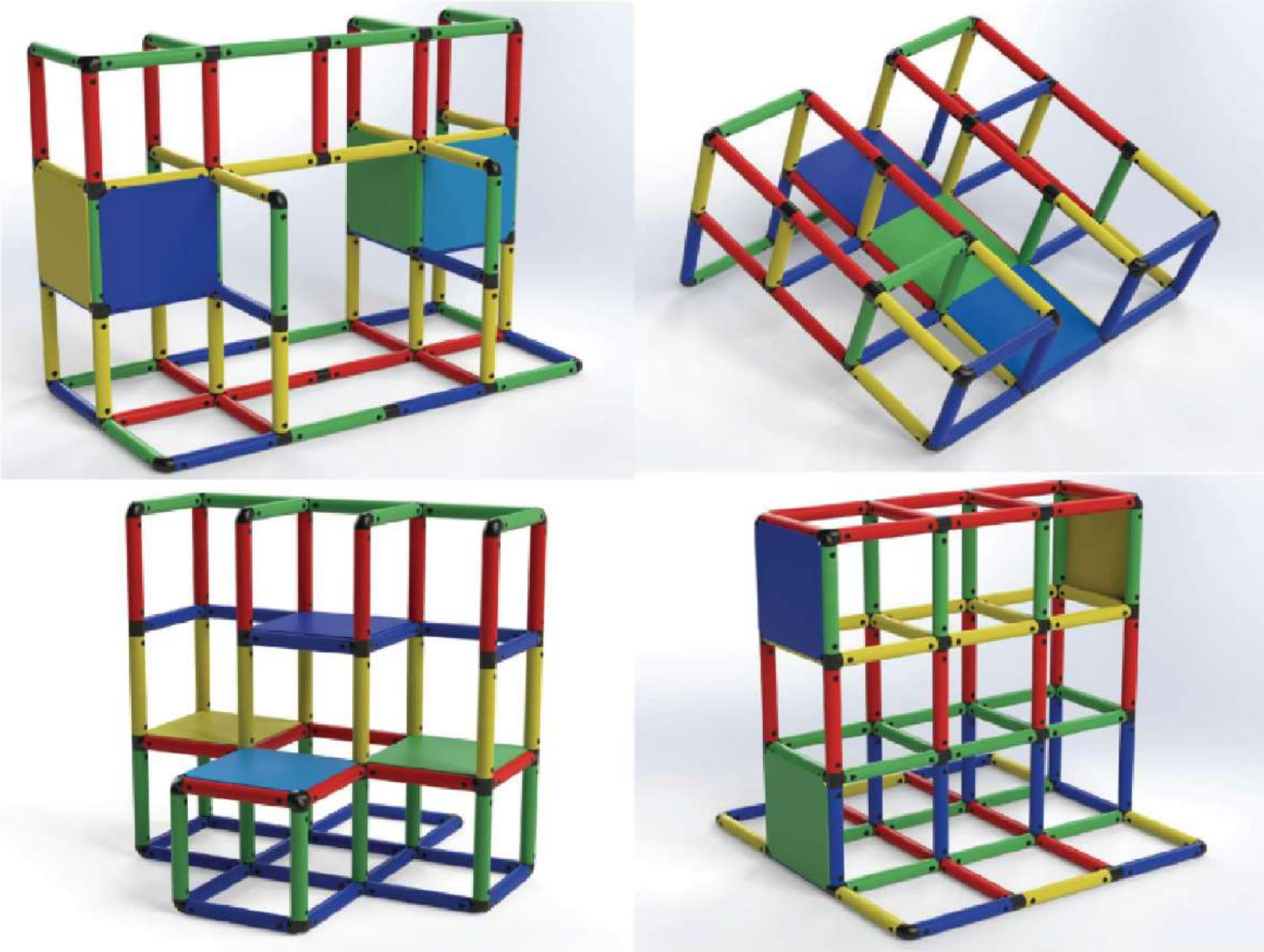

CLIMBING GYMS

FP-CG-1

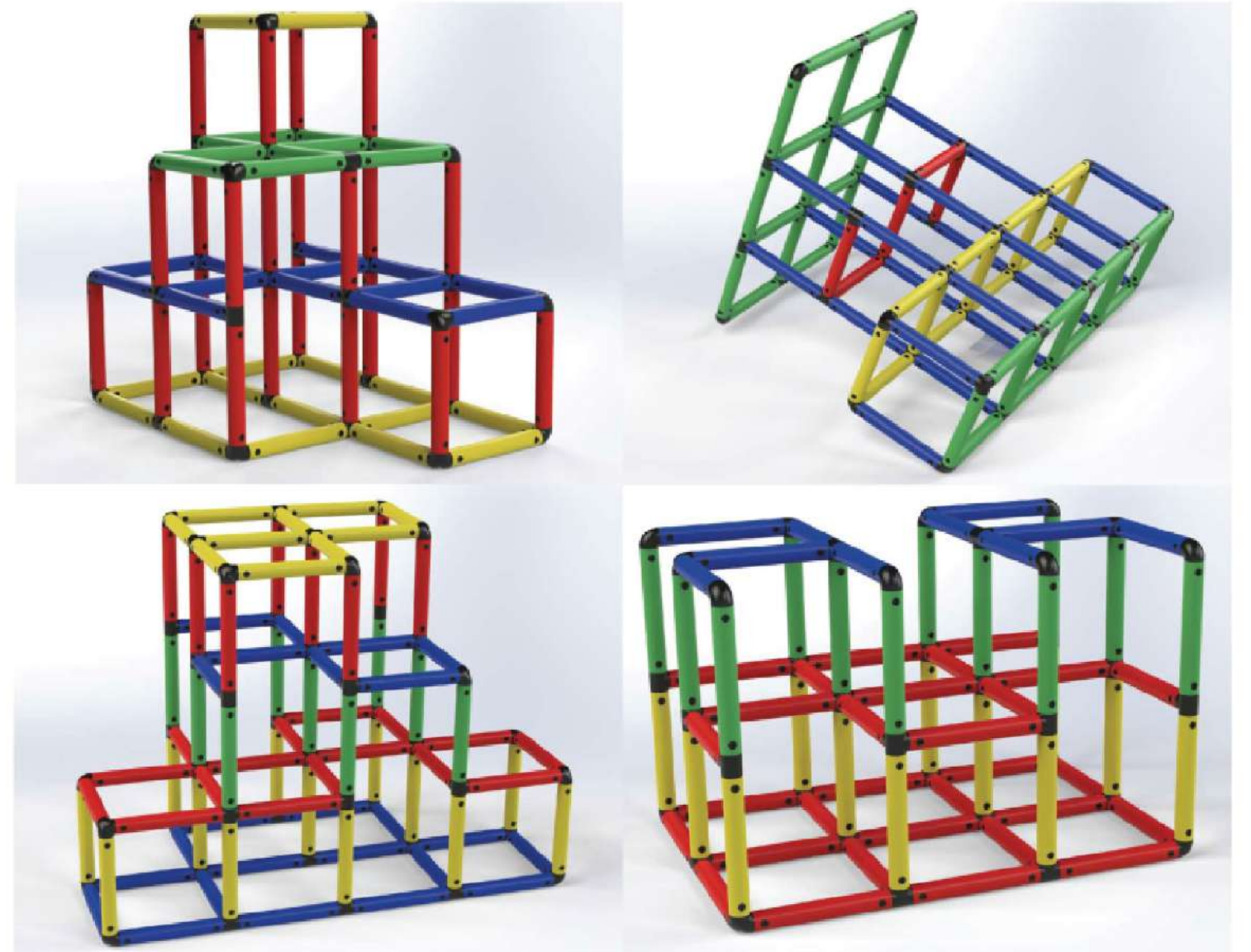

JUMBO SET

FPJS-2



THE ALL-IN-1 SET

FP-TA1-1



WHEELIES

FP-W-1

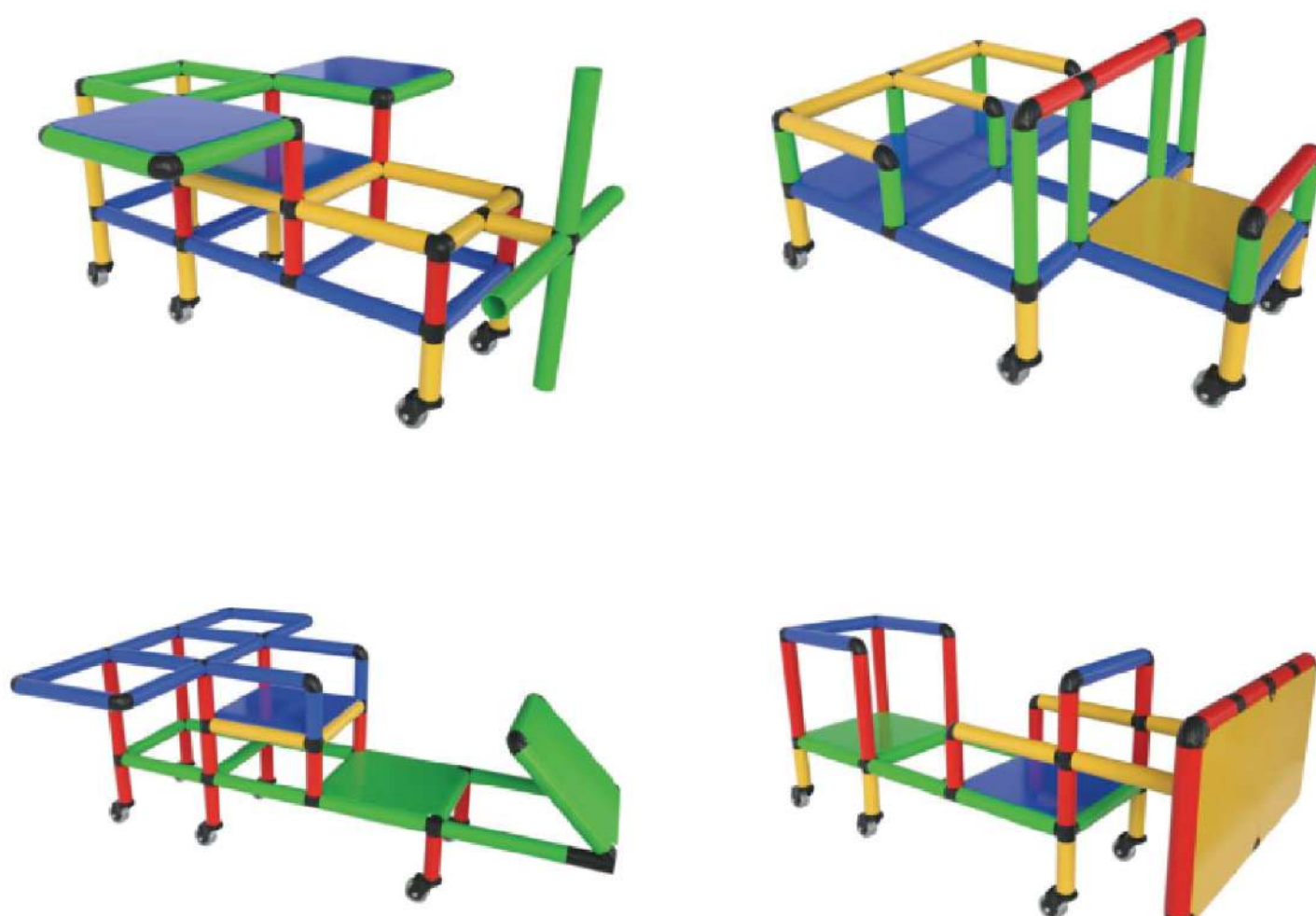

Swimming Pool

FP-SWP-1



Meet the Funphix Family! Collect them all!

Deluxe Set 296 PCS FPD LX-1

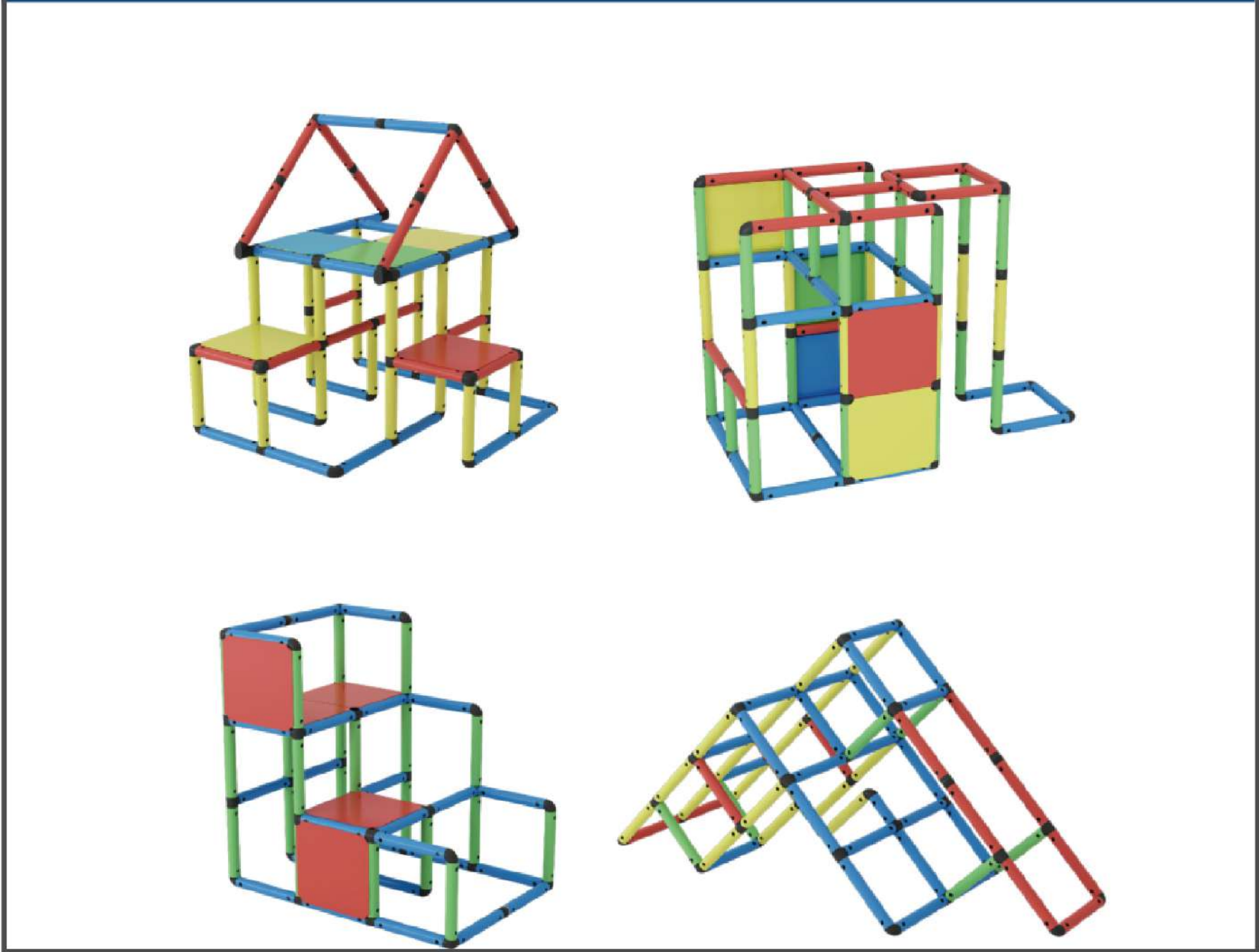

TODDLER FPTD-1

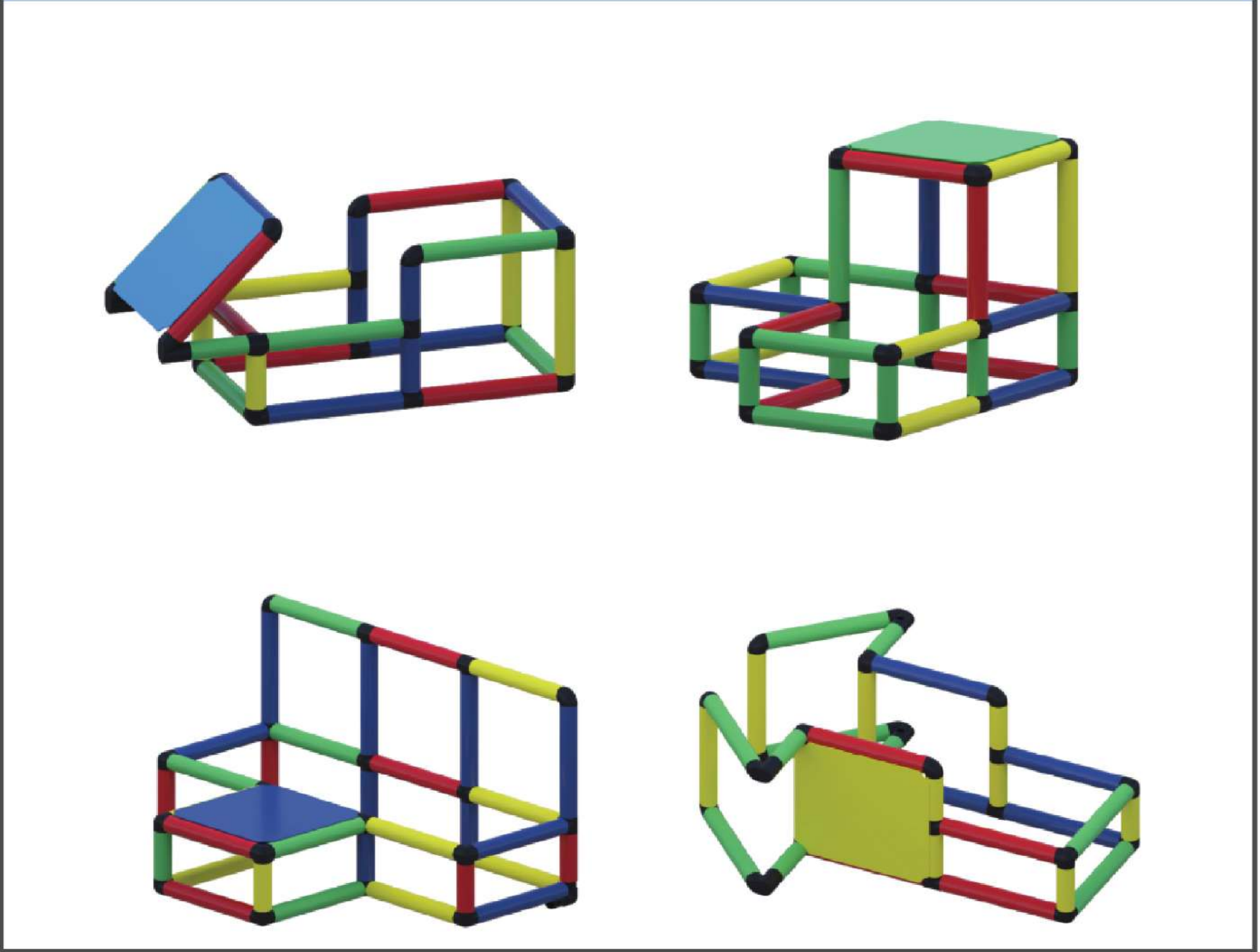

SPORTS SET FPSS-4B-1



199 PCS STANDARD SET FPSTND-1

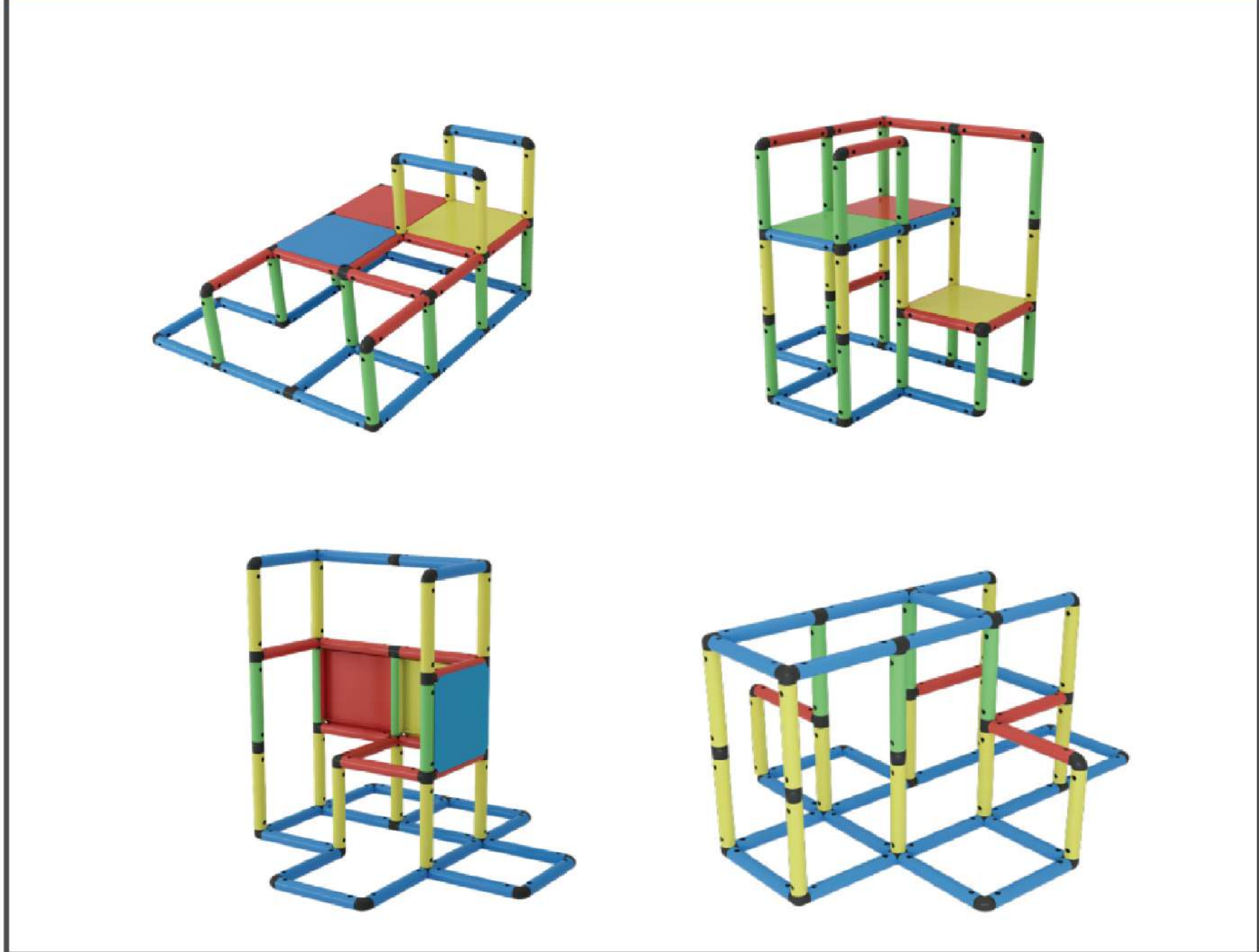

DOLL SET FPDS-2DOLL



FURNITURE SET FPFS-BED



Meet the Funphix Family! Collect them all!

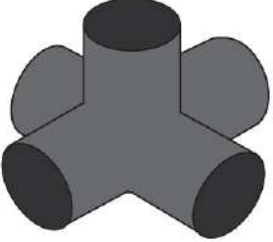

FP-CT-6
5 way Connector X2



FP-CT-7
4 way Connector X2

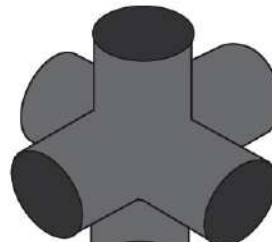

FP-CT-8
6 way Connector X2

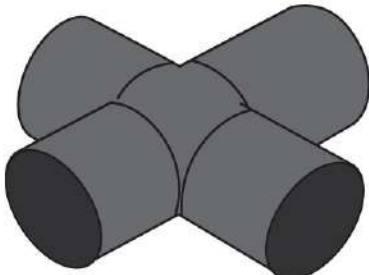

FP-CT-CR
Cross Connector X2

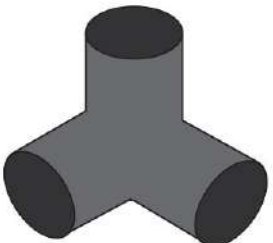

FP-CT-4
3 way Connector X2

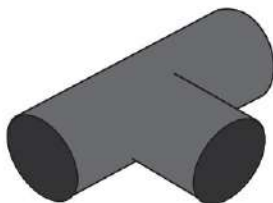

FP-CT-5
T Connector X2

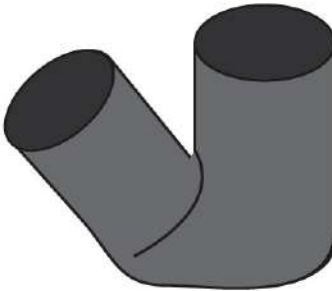

FP-CT-1
Diagonal Connector X2

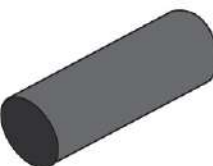

FP-CT-2
2 way connector X2

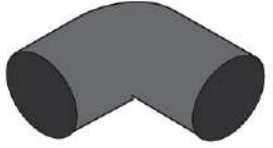

FP-CT-3
Elbow connector X2

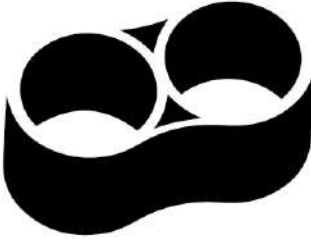

FP-C-DX
Duplex Connector X2



FP-TU/2-Y
5.8 Yellow Tubes X2

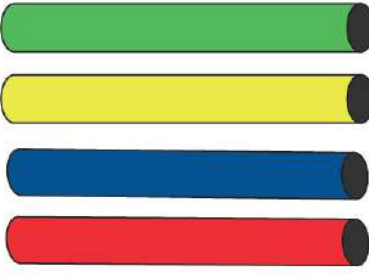

FP-TU-4
13.5 Tubes In 4 Color



FP-SWP-LINER
Funphix Swimming Pool Liner



FP-W-6
Funphix Wheels X6

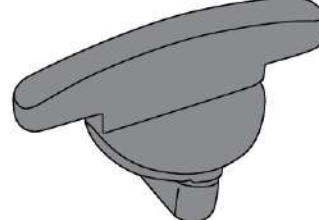

FP-PS-16
Pack of 16 Panel Screws

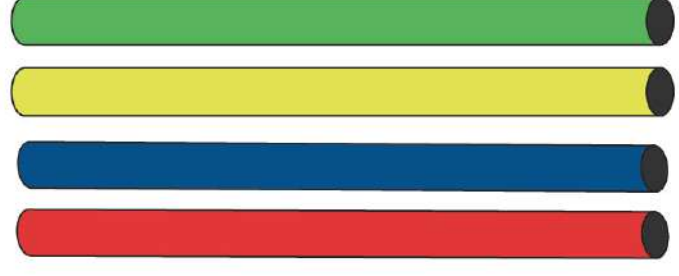

FP-TU-4L-C
29.13" Tubes in 4 Color



FP-HP-B-1
Half Panel - Light Blue



FPX-YBM
Funphix Bed Mattress

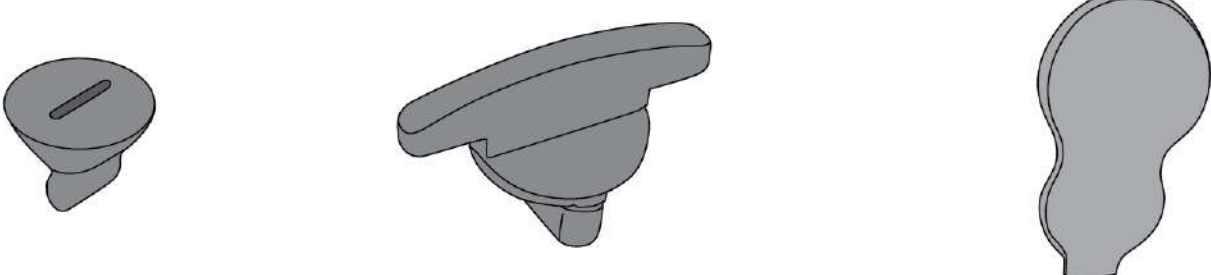

FP-T-50P-16-K
Pack of 50 Tube Screws, 16 Panel Screws, 2 Keys

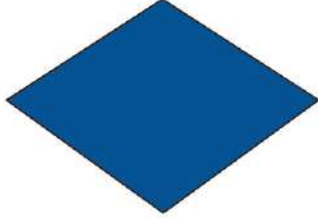

FP-PA-B-2
Dark Blue Panel



FP-PA-B-1
Light Blue Panel

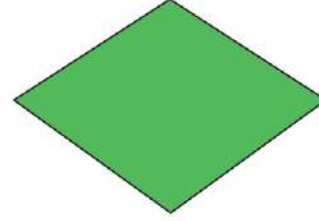

FP-PA-G
Green Panel

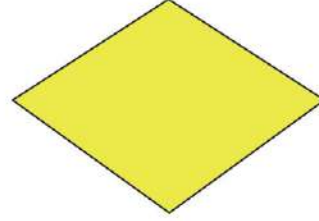



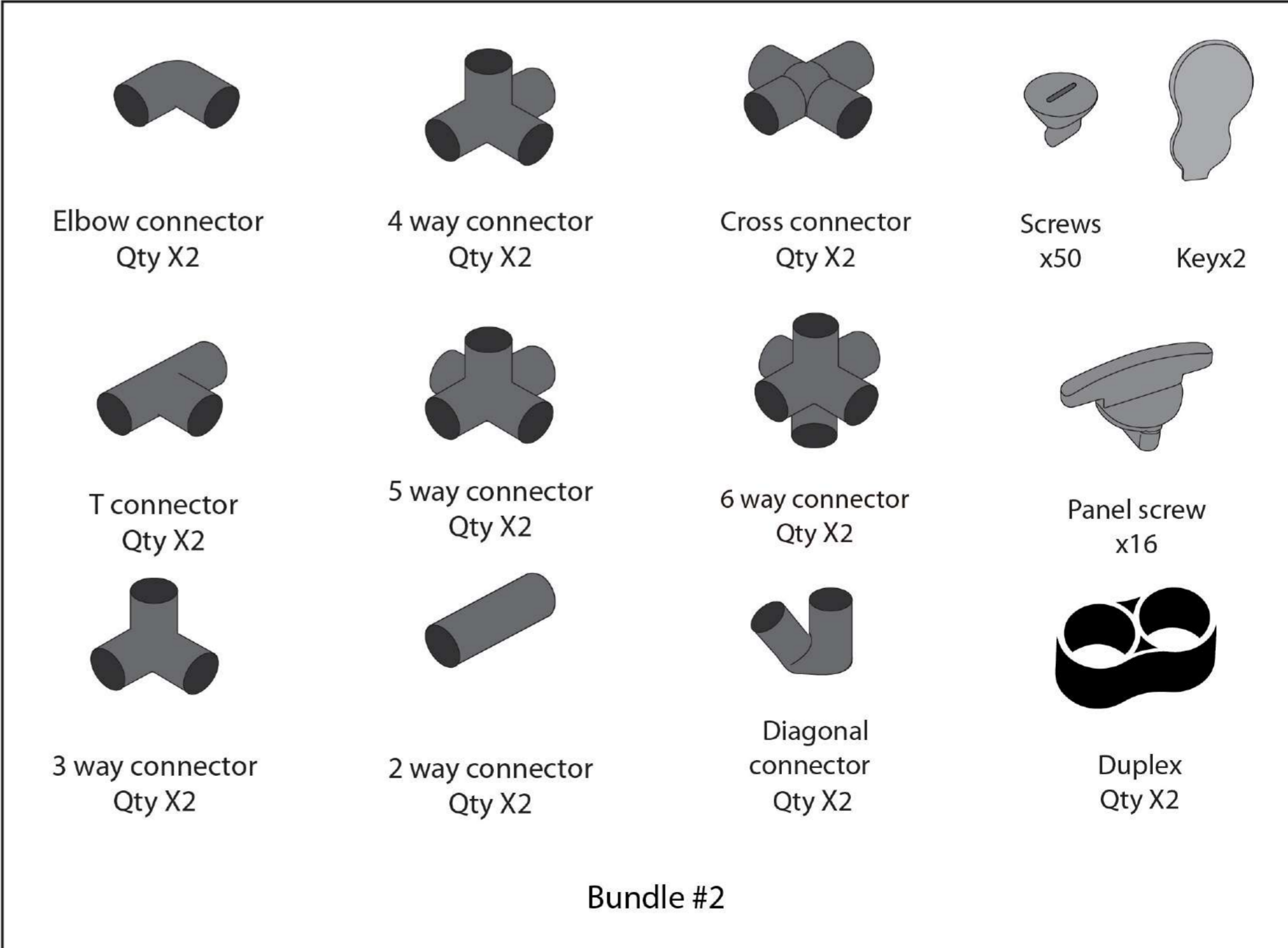
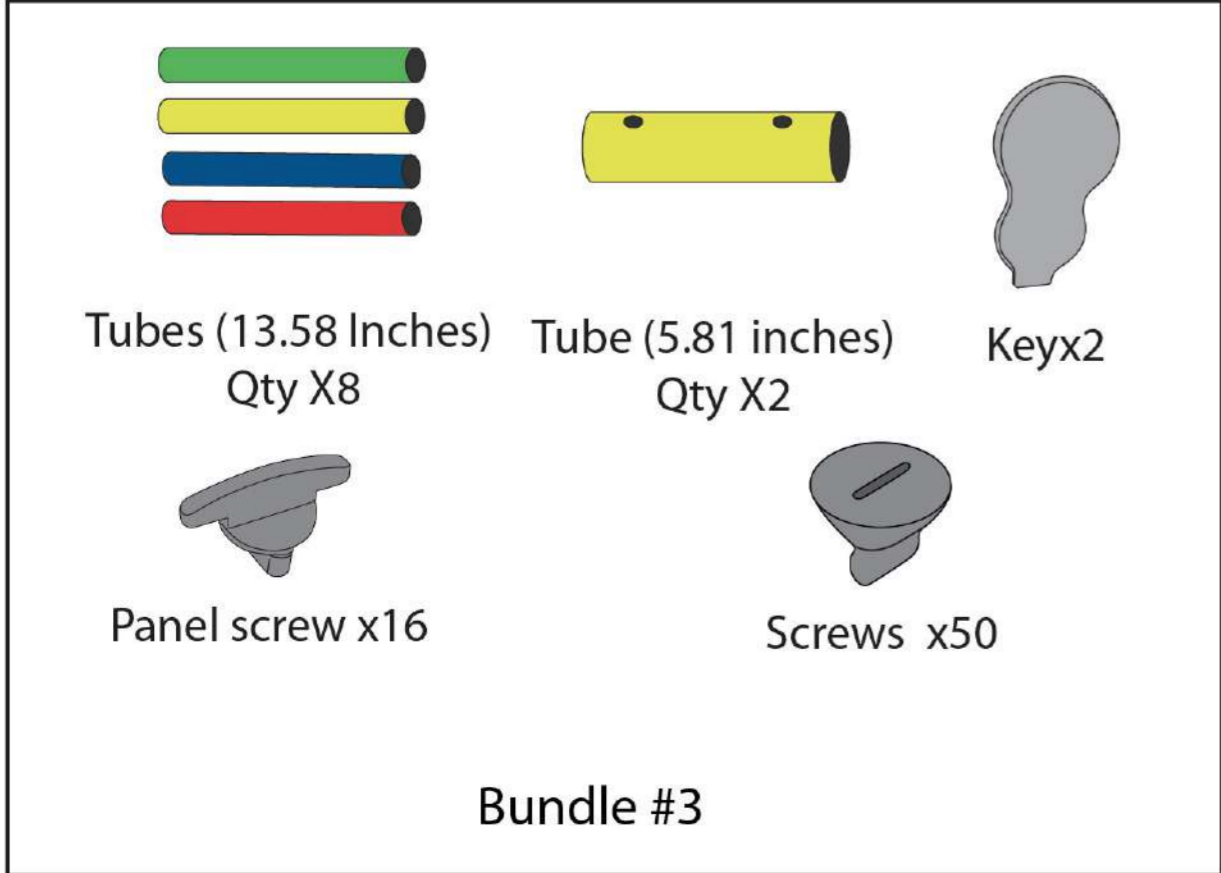
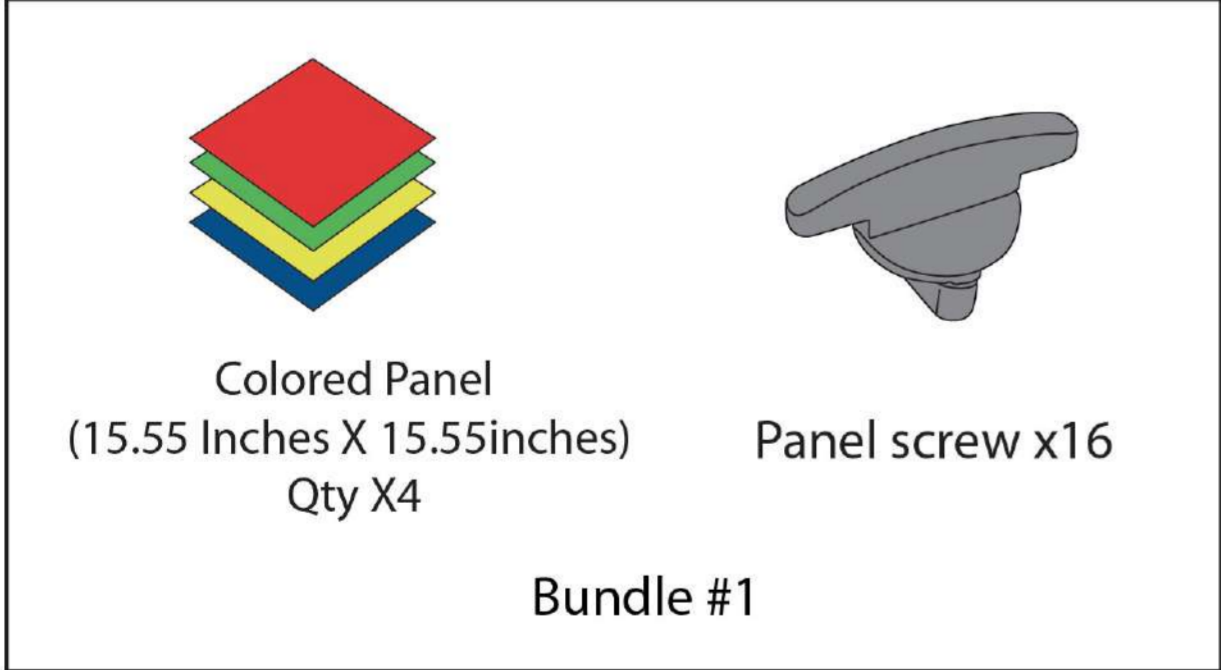
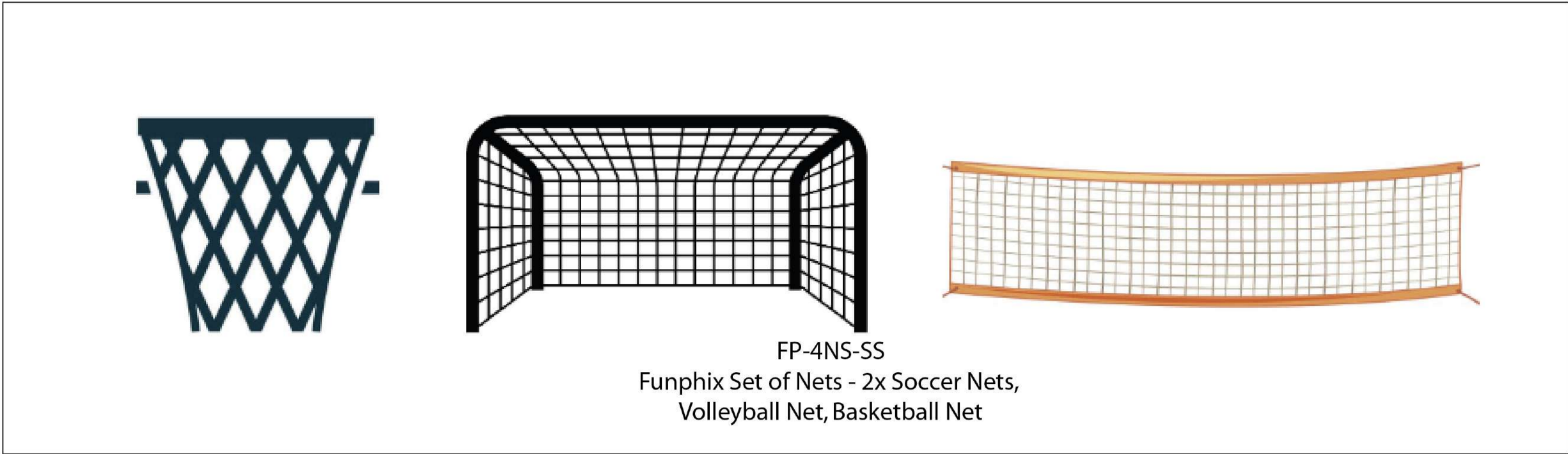

FP-PA-Y
Yellow Panel

Meet the Funphix Family! Collect them all!

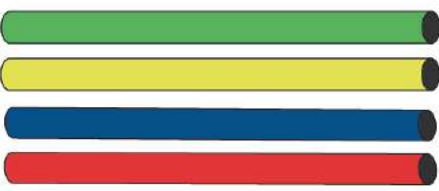
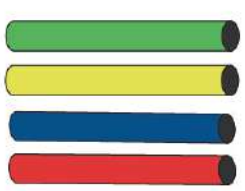

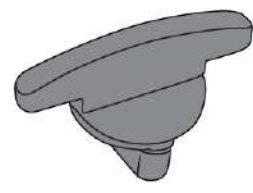
Meet the Funphix Family! Collect them all!

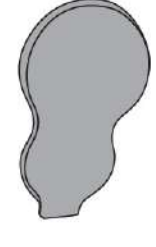
 Tubes (29.13Inches) Qty X8
 Tubes (13.58 Inches) Qty X8
 Tube (5.81 inches) Qty X2
 Panel screw x16
 Screws x50
 Keyx2







Bundle #4

 Funphix Swimming Pool Liner
 Funphix Wheels X6

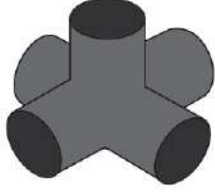
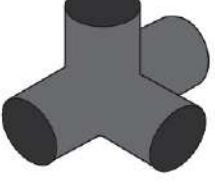
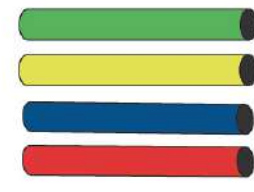
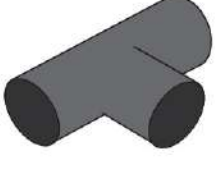

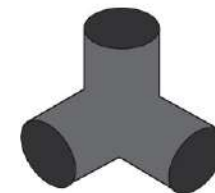

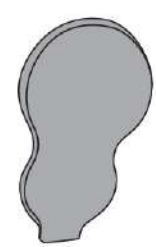

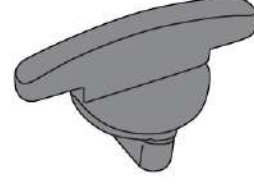
Bundle #6

 Funphix Swimming Pool Liner
 Tubes (29.13Inches) Qty X16

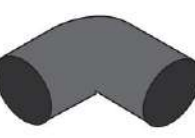
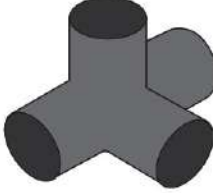
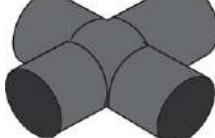

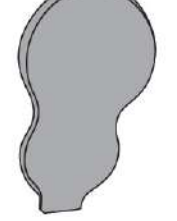
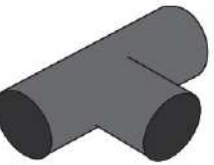
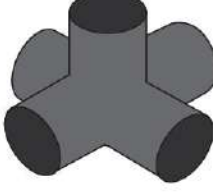
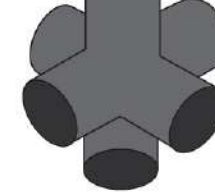
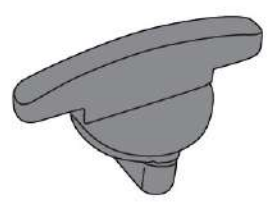
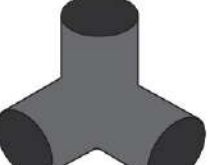
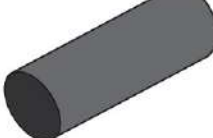
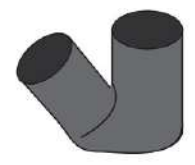
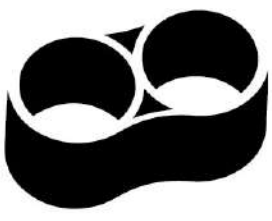

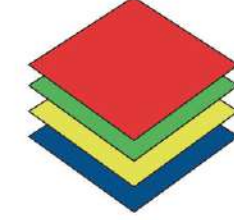

Bundle #7

 5 way connector Qty X2
 4 way connector Qty X2
 Tubes (13.58 Inches) Qty X17
 T connector Qty X4
 Tube (5.81 inches) Qty X10
 Colored Panel (15.55 Inches X 15.55inches) Qty X3
 3 way connector Qty X4
 Duplex Qty X2
 Keyx1
 Screws x65
 Panel screw x15

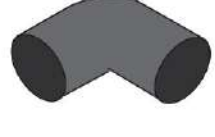
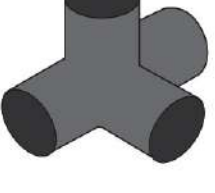
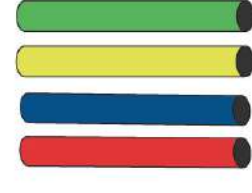
Bundle #9

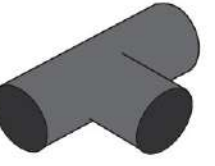
 Elbow connector Qty X2
 4 way connector Qty X2
 Cross connector Qty X2
 Screws x100
 Keyx2
 T connector Qty X2
 5 way connector Qty X2
 6 way connector Qty X2
 Panel screw x32
 3 way connector Qty X2
 2 way connector Qty X2
 Diagonal connector Qty X2
 Duplex Qty X2
 Tubes (13.58 Inches) Qty X8
 Tube (5.81 inches) Qty X4
 Colored Panel (15.55 Inches X 15.55inches) Qty X4
 Tubes (29.13Inches) Qty X8

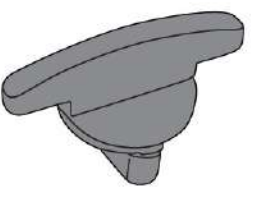
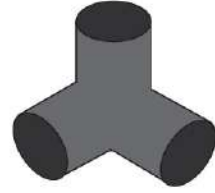
Bundle #5

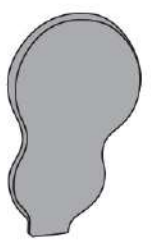
 Elbow connector Qty X4
 4 way connector Qty X2
 Tubes (13.58 Inches) Qty X11
 Screws x50
 T connector Qty X2
 Tube (5.81 inches) Qty X6
 Colored Panel (15.55 Inches X 15.55inches) Qty X2
 Panel screw x16
 3 way connector Qty X4
 Duplex Qty X2
 Diagonal connector Qty X2
 Keyx2

Bundle #8

To explore all our additional items and for more information check out our website

www.funphix.com

Feel free to contact our friendly staff for any questions or additional information at
support@funphix.com

fun

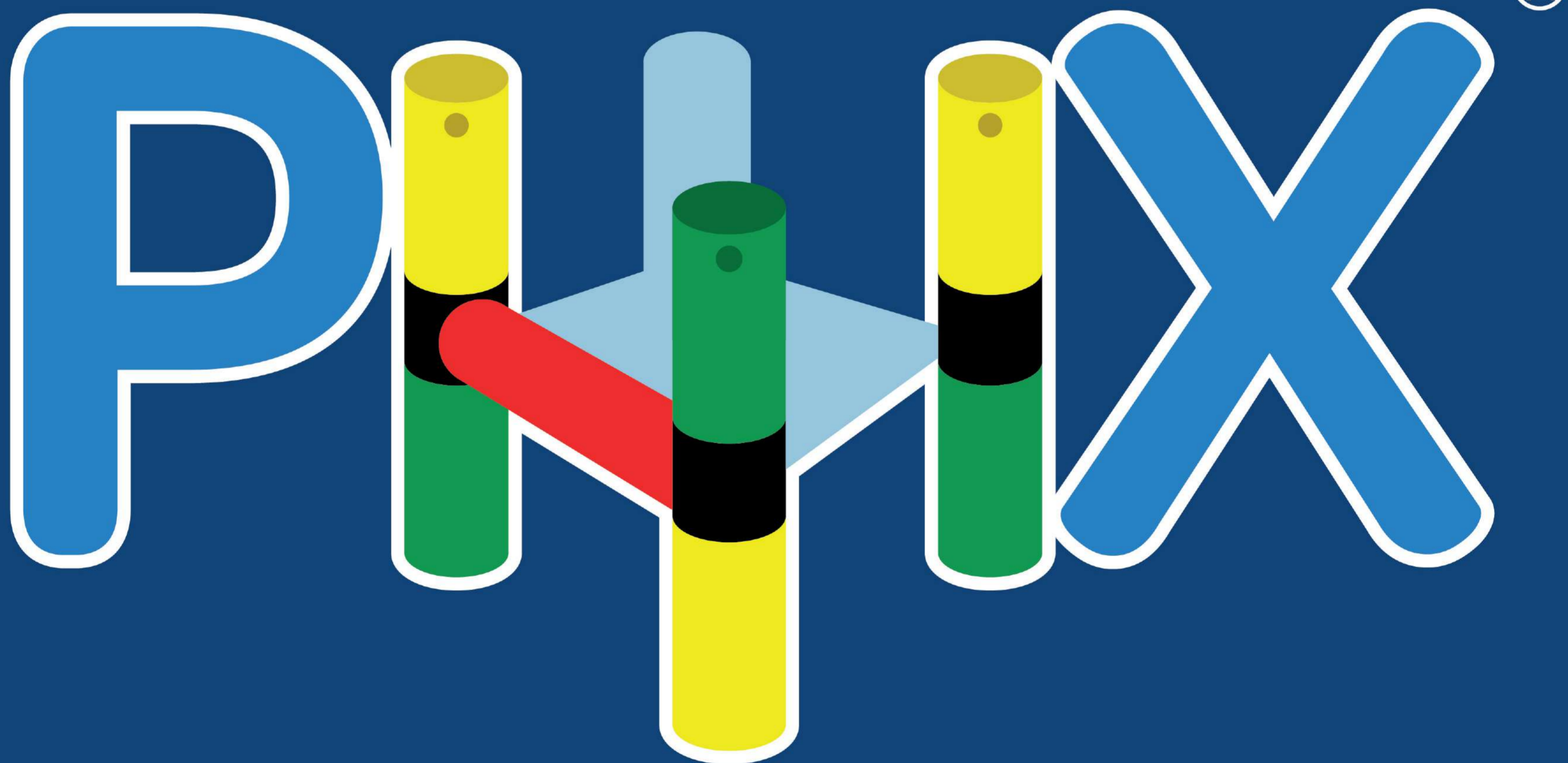

Build with it - Play on it™

© Funphix, All Rights Reserved.