



Build with it - Play on it™



FUNPHIX CREATE AND PLAY LIFE-SIZE STRUCTURES THE ALL-IN-1 SET



Before you begin to use this toy, you must read all the information in this manual.

Warning:

Do not sit, stand, or climb or play on your structure until all screws are secured into their place. A screw must be inserted into the tube hole that aligns with the connector for the toy to be safe and secure. The screws must be inserted on both ends of each tube. The toy will fall apart without the screws in place.

- You can only apply weight on the panels, when you secure the panels with the panel screws, to the supporting tubes on all four sides. Never push the panels out from the inside, always remove them carefully by first removing screw fasteners .

- Throwing the panel may result in the panel chipping at the edges.

- All play structures need to be assembled and tested by an adult "supervisor", according to the instructions and safety standards listed below.

- The product is intended for home/domestic use only and is not suitable for professional or commercial use, nor for municipal playgrounds.

- When you assemble a play structure, follow the exact instructions in the manual.

- Place the bottom supports of play structure on a flat surface. Do not place your structure on an elevated or inclined surface, your play structure should always be at floor level or ground level.

- Whether used indoors or outdoors, place the structure on a safety floor material i.e. Carpet, mats grass ,shredded tire etc.

Supervision and playing

1. An adult must always be present to watch over the children when they are building, playing or using the structures. Parents are liable for the children's actions.
2. Children Play on the play structures at their and their parent's own risk
3. Do not misuse the play structures, use it for the purpose it was intended.
4. The maximum weight on the structures is a total of 150Lbs.
5. No play should be allowed on structures which have not been completed, been damaged, or destroyed, or altered ,or partially or fully unassembled.
6. Do not use the play structure when the parts of the structure reach a temperature of 100 degrees F.
7. Ensure that the environment around the structure is safe and that no flame or heat producer or anything hazardous is near.
8. Do not use or store the product next to any fire.
9. Do not use any broken parts.
10. Do not throw the tubes or panels.

Maintenance

- Inspect your play structure before each use, make sure there are no loose contents, missing parts, screws, or broken pieces. Any missing or damaged pieces should be replaced immediately.
- Maintain the pieces by periodically washing the play structures with warm water and a little detergent. Do not use any harsh detergent or compounds on the surfaces.
- The color of the plastic pieces may fade by sunshine, you can however use them indoors and outdoors. Store indoors, and if left outside for a long time make sure to cover it and protect everything with a cloth.
- Not following these guidelines is not only dangerous to children, but will also immediately void any warranty.

Warning:

This package has small parts that can be swallowed! Not for children under 3 years. There is danger of choking and/or suffocation!

Parts list

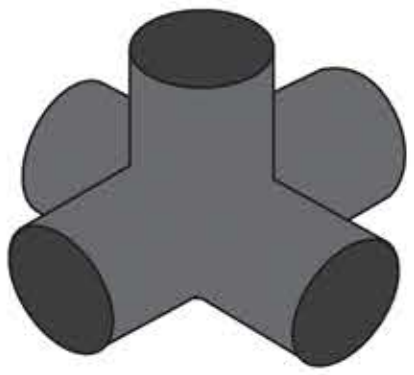

5 way connector
Qty X16

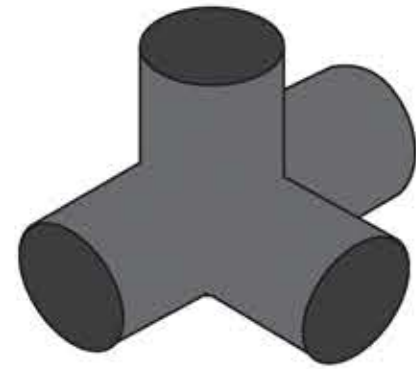

4 way connector
Qty X19

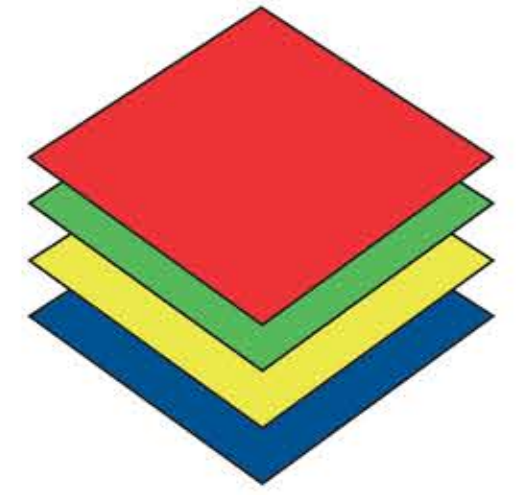

Colored Panel
(15.55 Inches X 15.55inches)
Qty X9

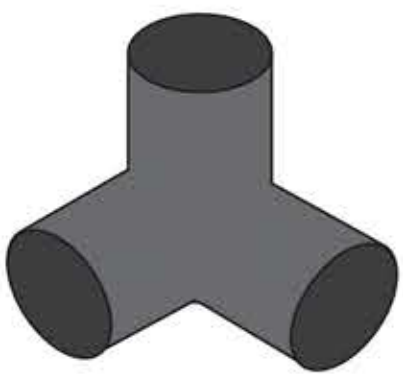

3 way connector
Qty X14

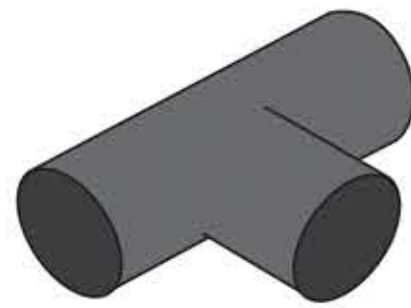

T connector
Qty X28



Tubes (13.58 Inches)
Qty X100

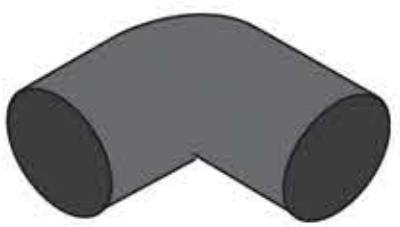

Elbow connector
Qty X18

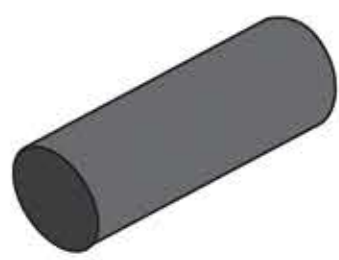

2 way connector
Qty X15



Screws
Qty X226

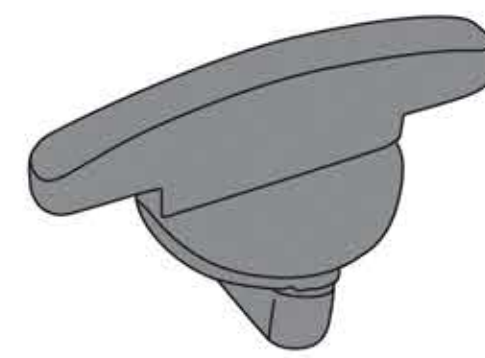

Panel screw
Qty X36

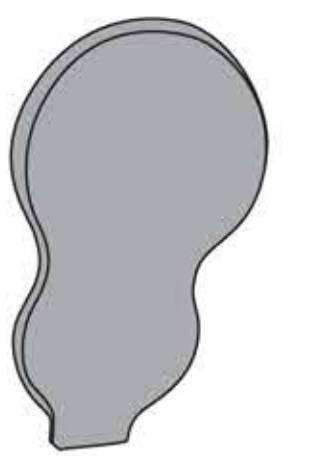

Key
Qty X2



Tube (5.81 inches)
Qty X13



Duplex
Qty X4



Wheel combination
Qty X6

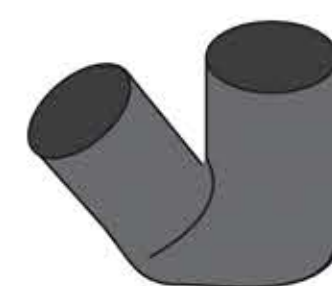

Diagonal
connector
Qty X4

Instructions on How to assemble structures

- The screws are secured as well as removed by insertion of tube over connector followed by a screw through both tube and connector's aligned holes, followed by a 90 degree turn.

To detach the tube from the connector, first remove the screw by turning it back 90* then turn the tube slightly and remove it from the connector.

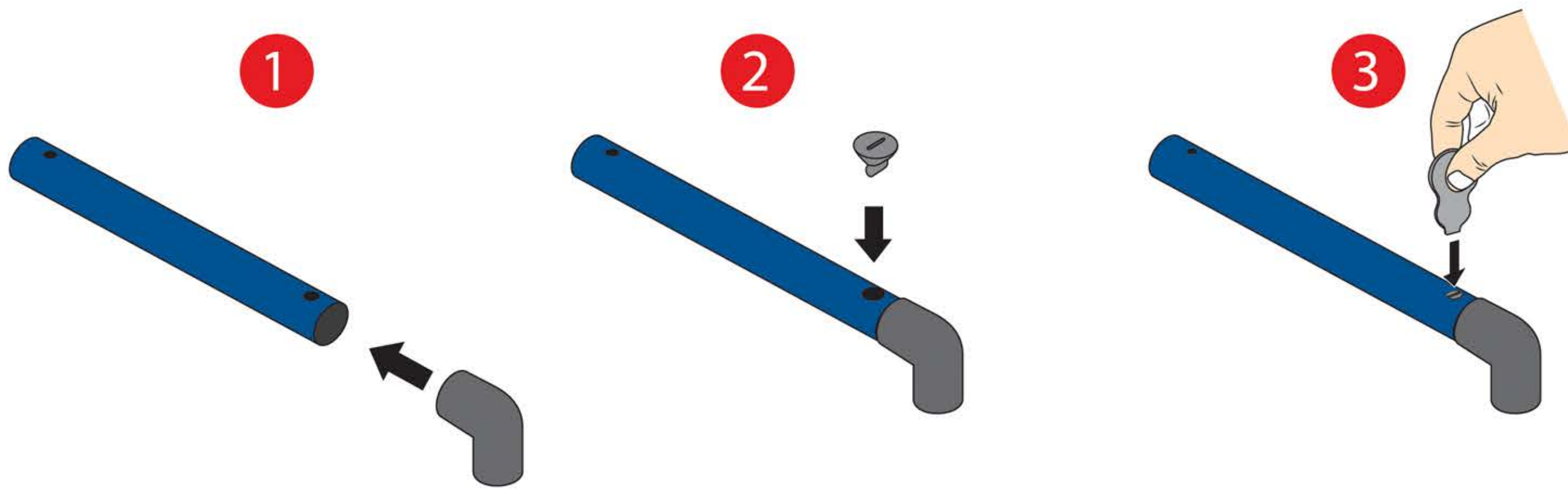

- It will be simpler to build a structure from the base up, complete the first level and then continue on to the next level just above . Insert the screws only after the structure is completely assembled. When inserting the screws, also work your way up starting from the bottom up completing upwardly each level.

- Prepare your structures of tubes and connectors beforehand, so that you will not have to force any pieces , See image below showing correct assembly and incorrect assembly.

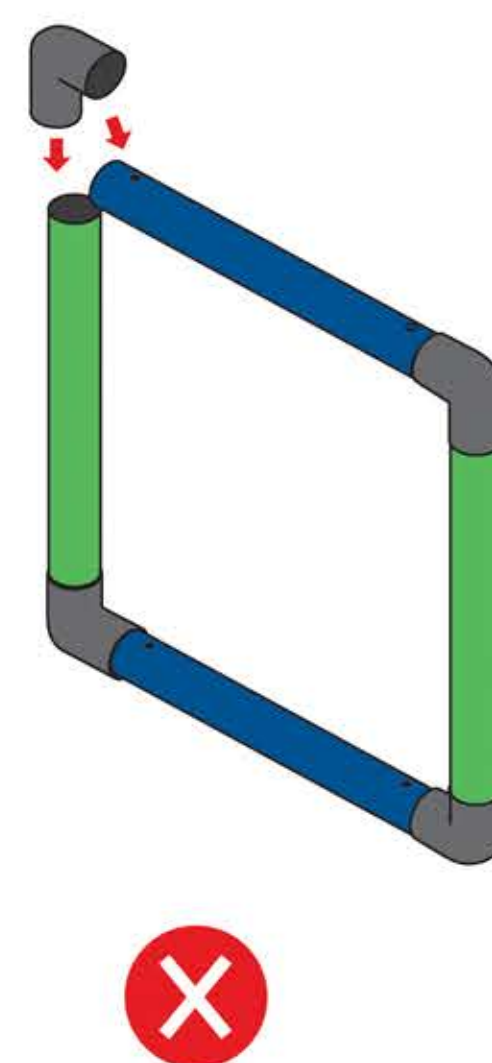
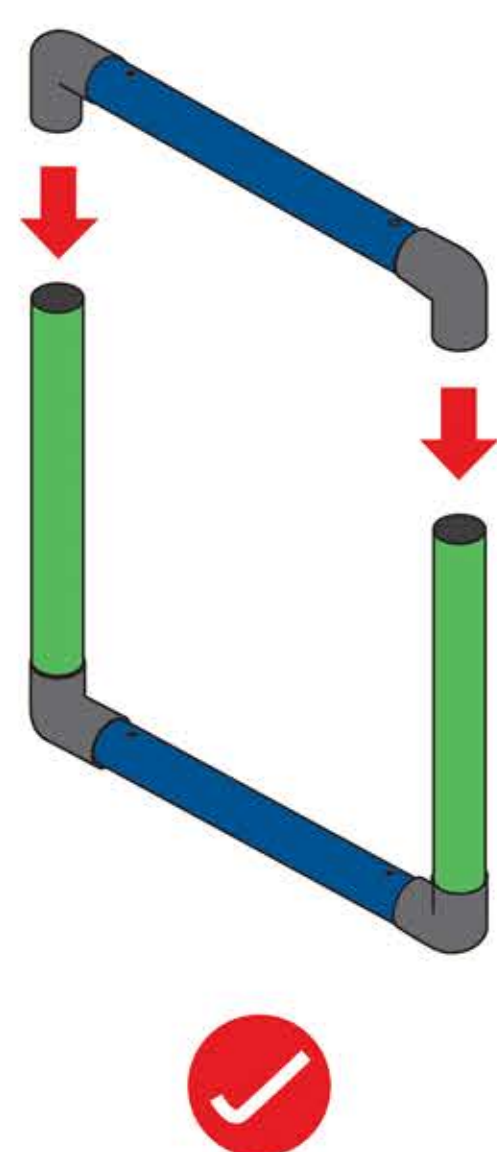

- Remember when inserting the screws for the tube and connector where you want to insert panels as those places will be secured by the required panel screws. Each tube only has 2 screw holes and therefore you will have to ensure that the panels are put extending in different directions when sharing the same tubes. So that you can insert the necessary panel screws in each panel hole and tube . See image below.



- When assembling your own structure, always make sure to build a stable support by adding to the width, as you are making the structure taller .

Make sure to test your self-designed structures to ensure they are stable and safe and will not tip over. Do not build tall or wobbly structures.

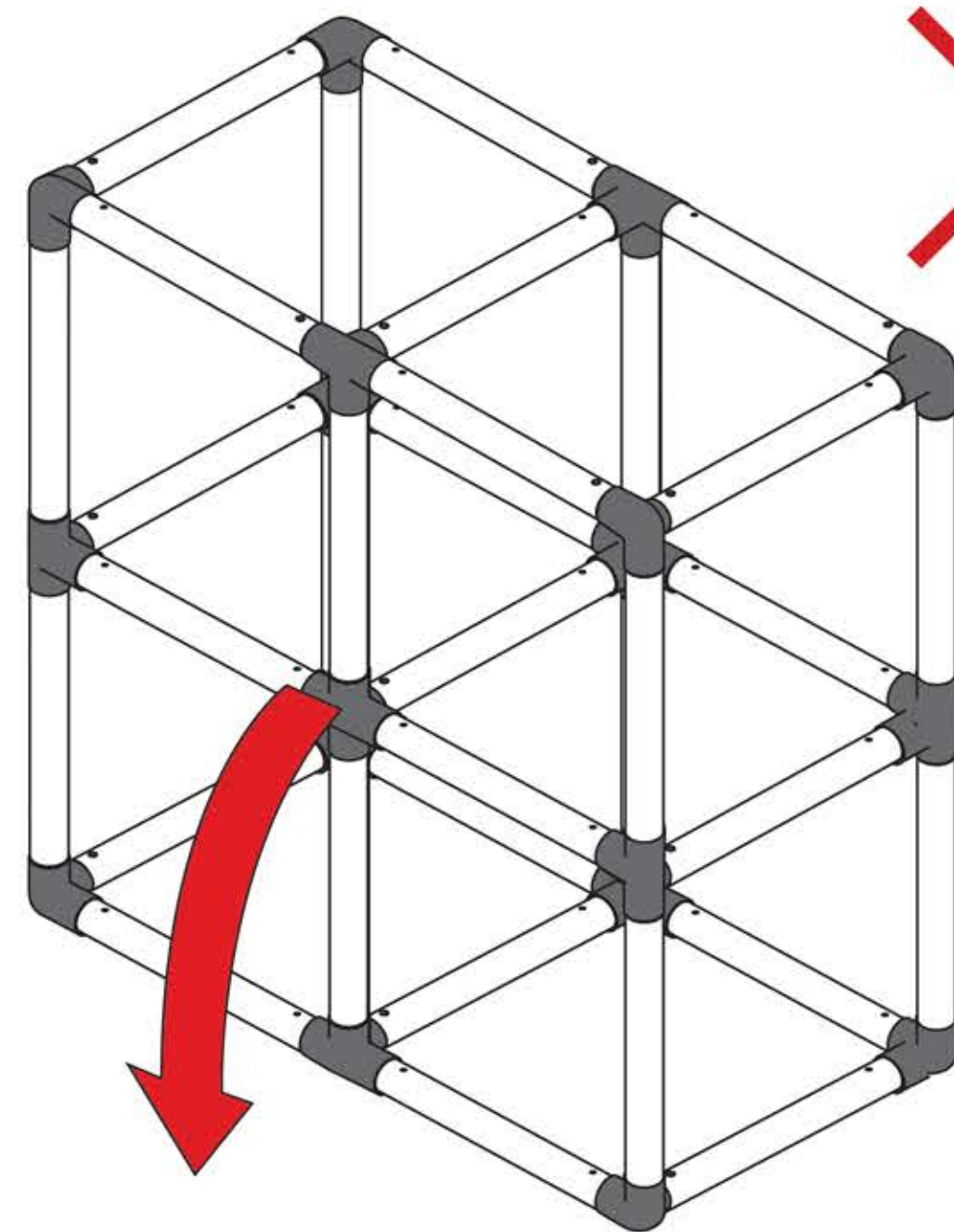
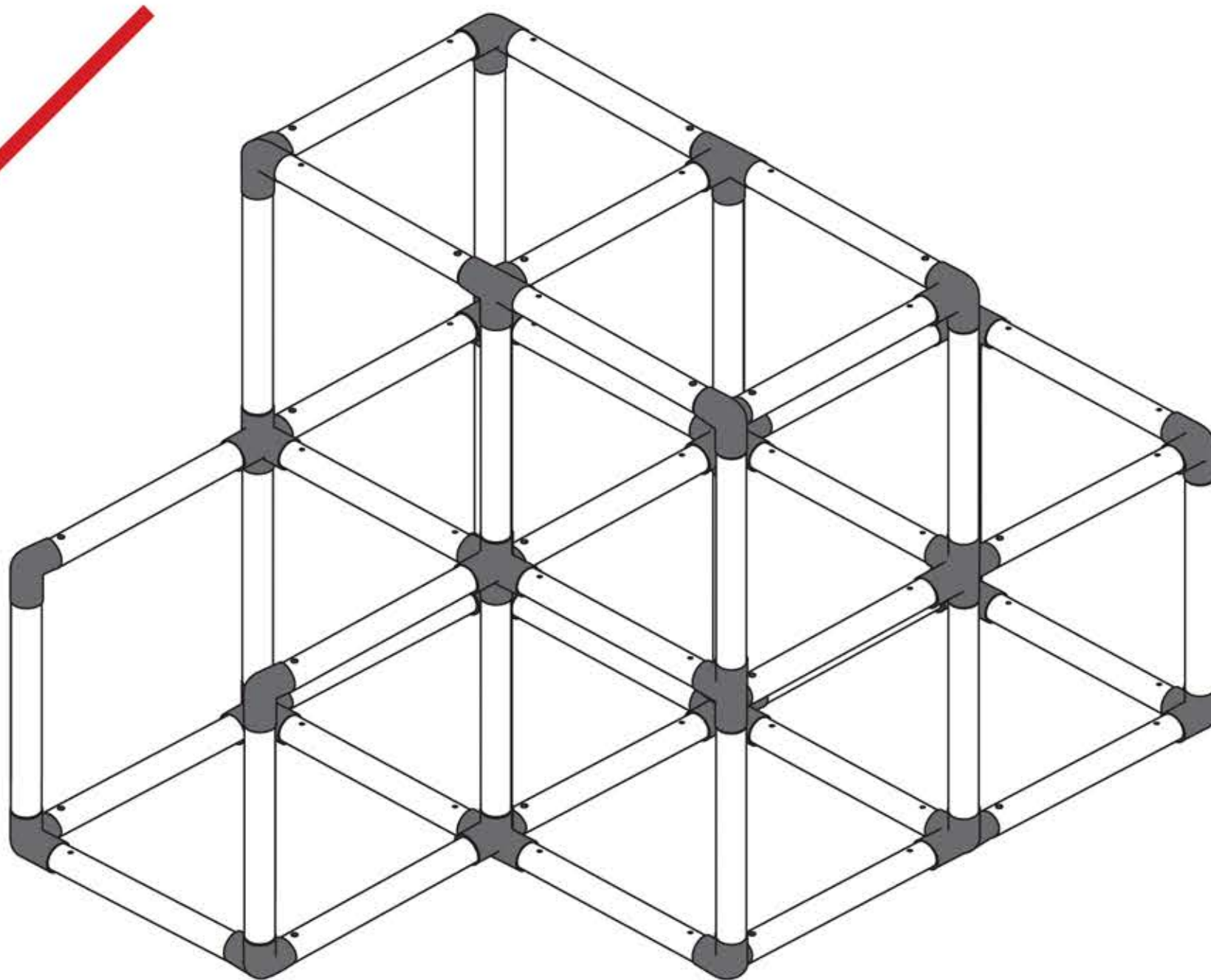

Safety Instruction for Wheeled Structure.

- Parents/Adults should check the structure from time to time to ensure that the necessary screws are fastened tight.
- The wheels should be inspected to ensure that they are not loose; each one should be firmly attached to its tube.
- Do not ride your wheeled structure on bumpy surfaces.
- Wheeled structures should not be used near pools, roadways, alleys, hills, or holes
- The wheeled structure should not be used by more than two children at a time, do not allow more than the allowed weight.
- Ensure that all parts of the wheeled structure fitted to maintain balance are tightly fitted and that they are used properly by your children. This will allow for balance and stability during use of the wheeled structures.
- Ensure that your children remain seated while using the wheeled structure. Do not allow them to stand on the structure. Ensure that the structure has completely been brought to a stop before descending.
- Shoes should be worn while riding on the wheeled structure with the prescribed number of passengers riding each time. Passengers should remain seated with hands and legs within the wheeled structure.
- Sit only on the space provided for sitting.
- Do not use the wheeled structure on a wet surface.
- Ensure that the structure is not pushed from behind as it might lead to uncontrollable acceleration.
- Avoid accidents by ensuring that little children do not sit or crawl in the path of the wheeled structure.

See below illustrations if you need to assemble the parts of the wheel.



Instructions on how to assemble structures with wheels

- First, build the structure with the tubes and connectors. Once the structure is fully assembled and the screws are secured in its place, only then will you add the wheels to the structure.
- Remember when building the structure, to always leave an end of the connector extending downward where you want to secure the wheels.

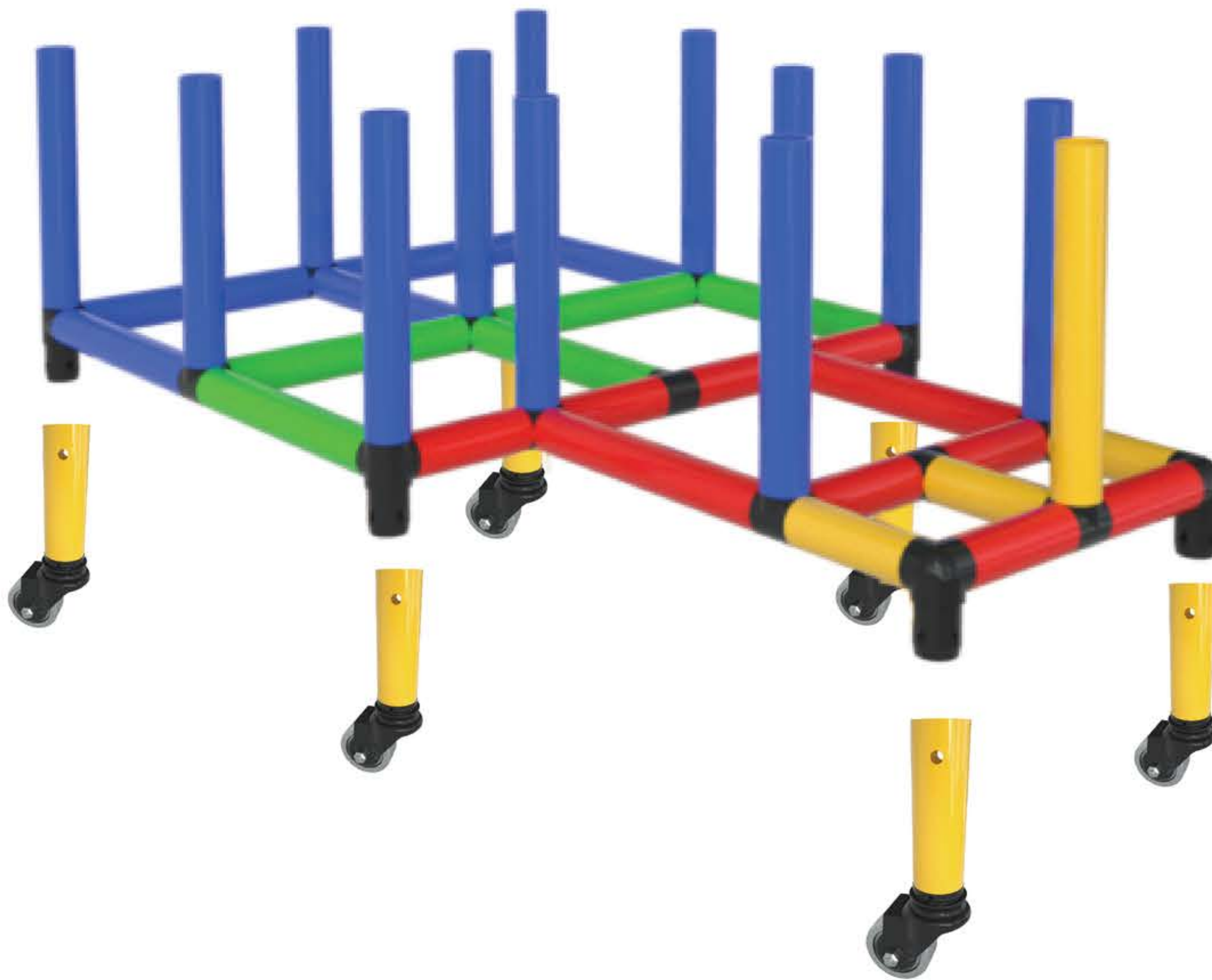

- Put the tube of the assembled wheel over the connector, and secure with a screw.
- Do not build structures more than 1-1.5 levels high. Always make sure to add the correct number of wheels to make it a balanced wheeled structure (Preferably use all six wheels included with the set).



Instructions how to use the Duplex connector

- When assembling a slide or a slanted structure with more than 2 panels, make sure to add tubes to the bottom of the slide aiming towards the surface below, so that the structure gets additional support. See image below

See images how to use the duplex connector

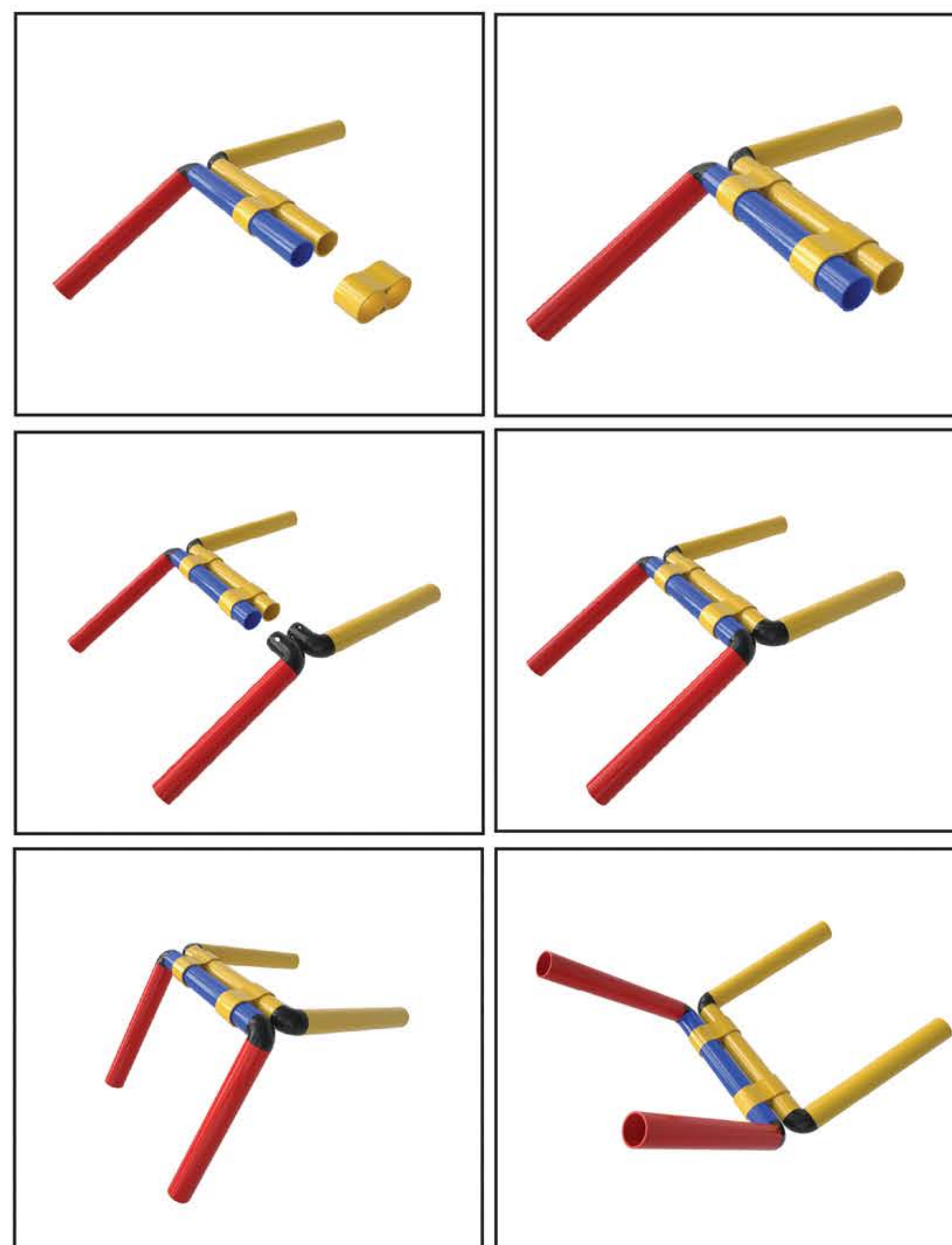
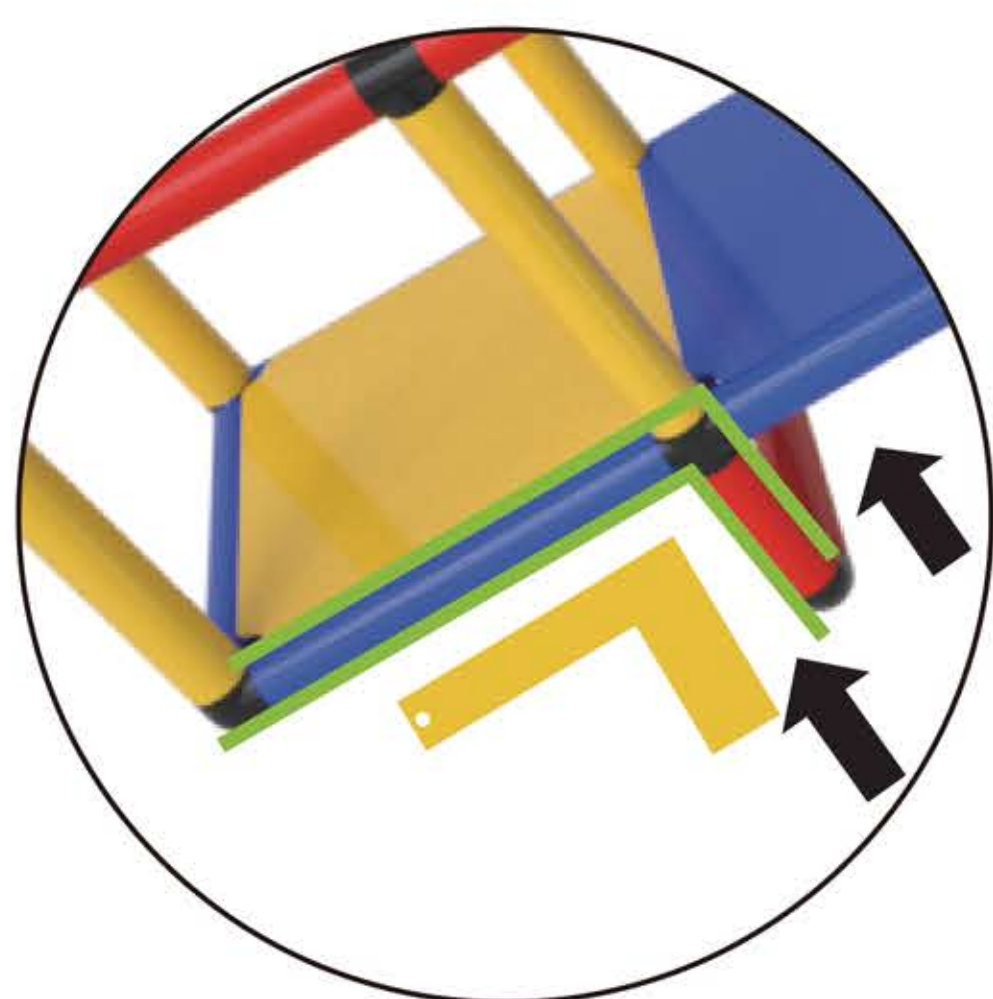

Warranty

It is our ultimate goal to serve our happy customers.

Funphix provides

5 Year warranty on Funphix parts when used indoors.

3 year warranty on Funphix parts when structures has been used or stored outdoors for greater than 3 months.

Dear kids,

The team at funphix is excited to see you creating your own play structures. Send us a picture or video of your play structure which you self-designed or built from the manual. We will consider posting it on our gallery. Send the image to mystructure@funphix.com

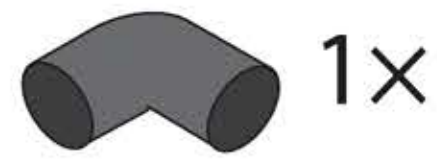
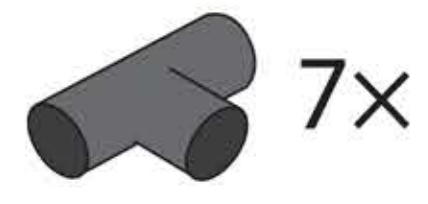
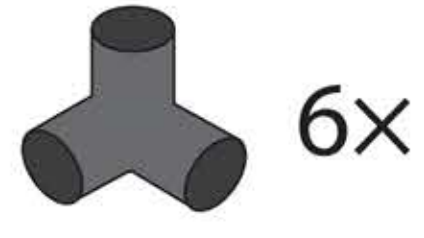
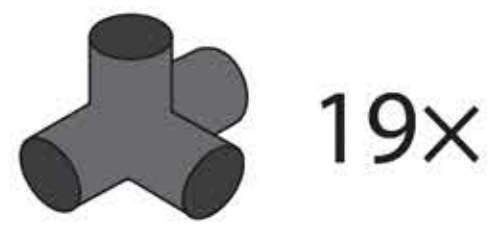
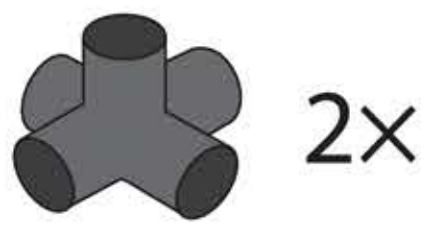

1

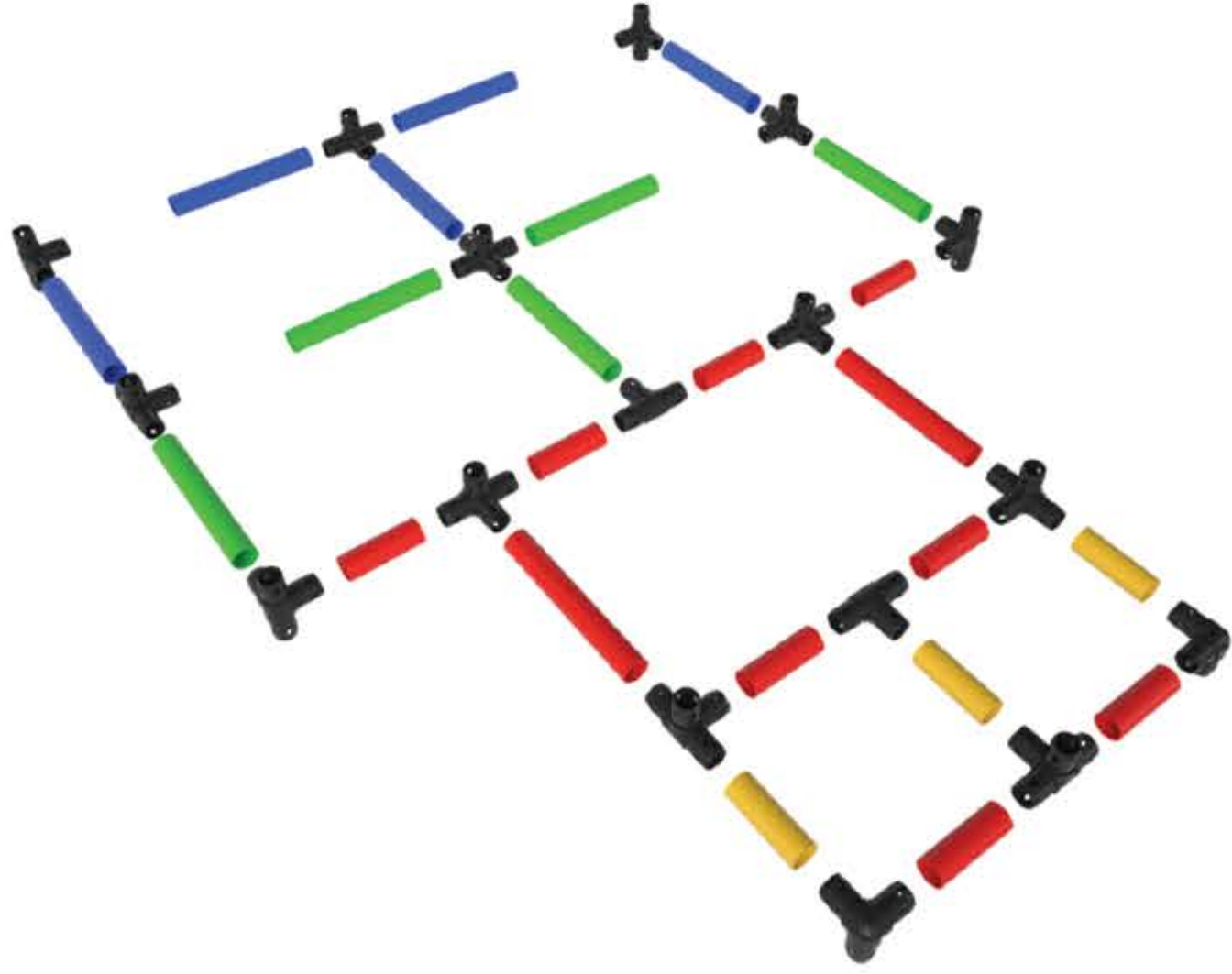

2

Automobile

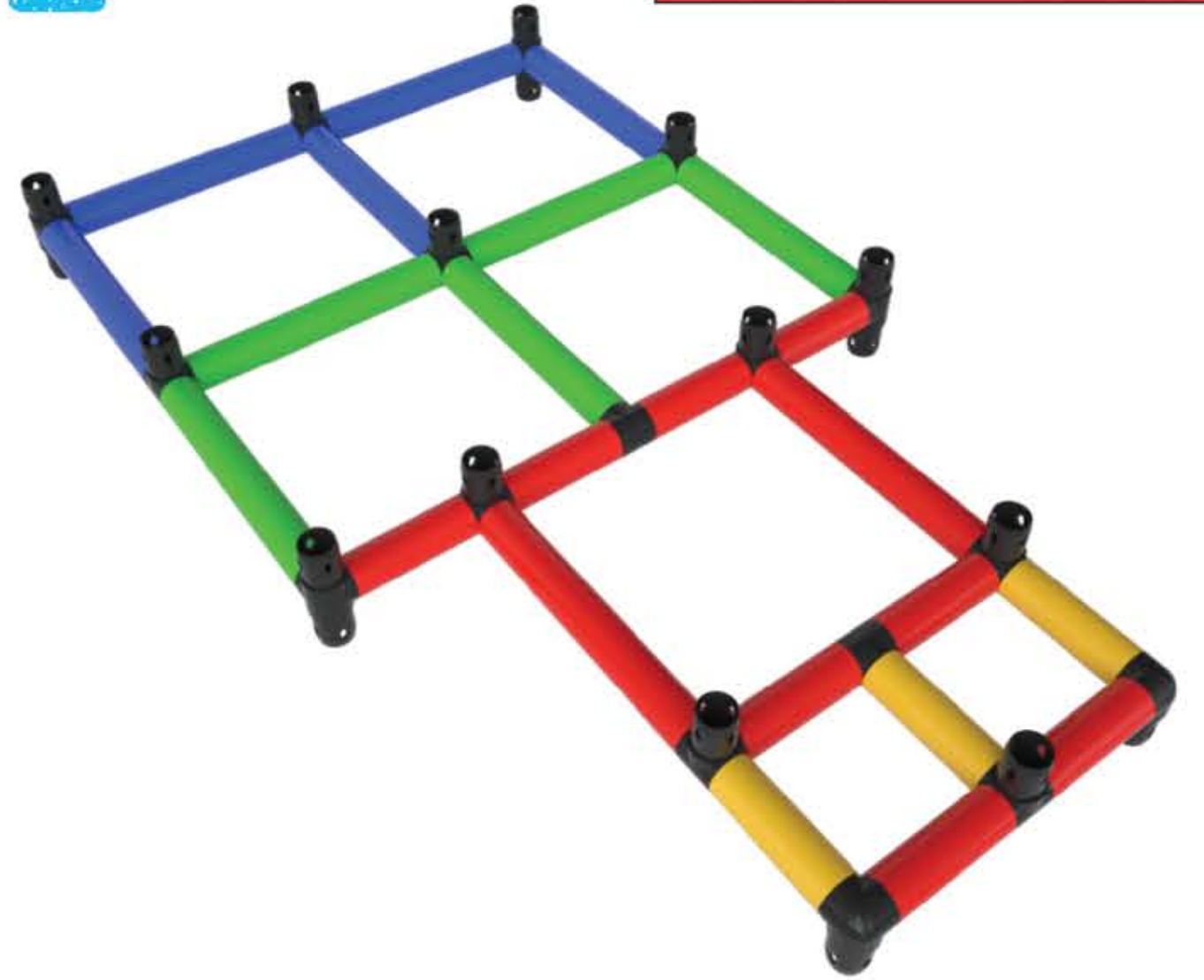

3

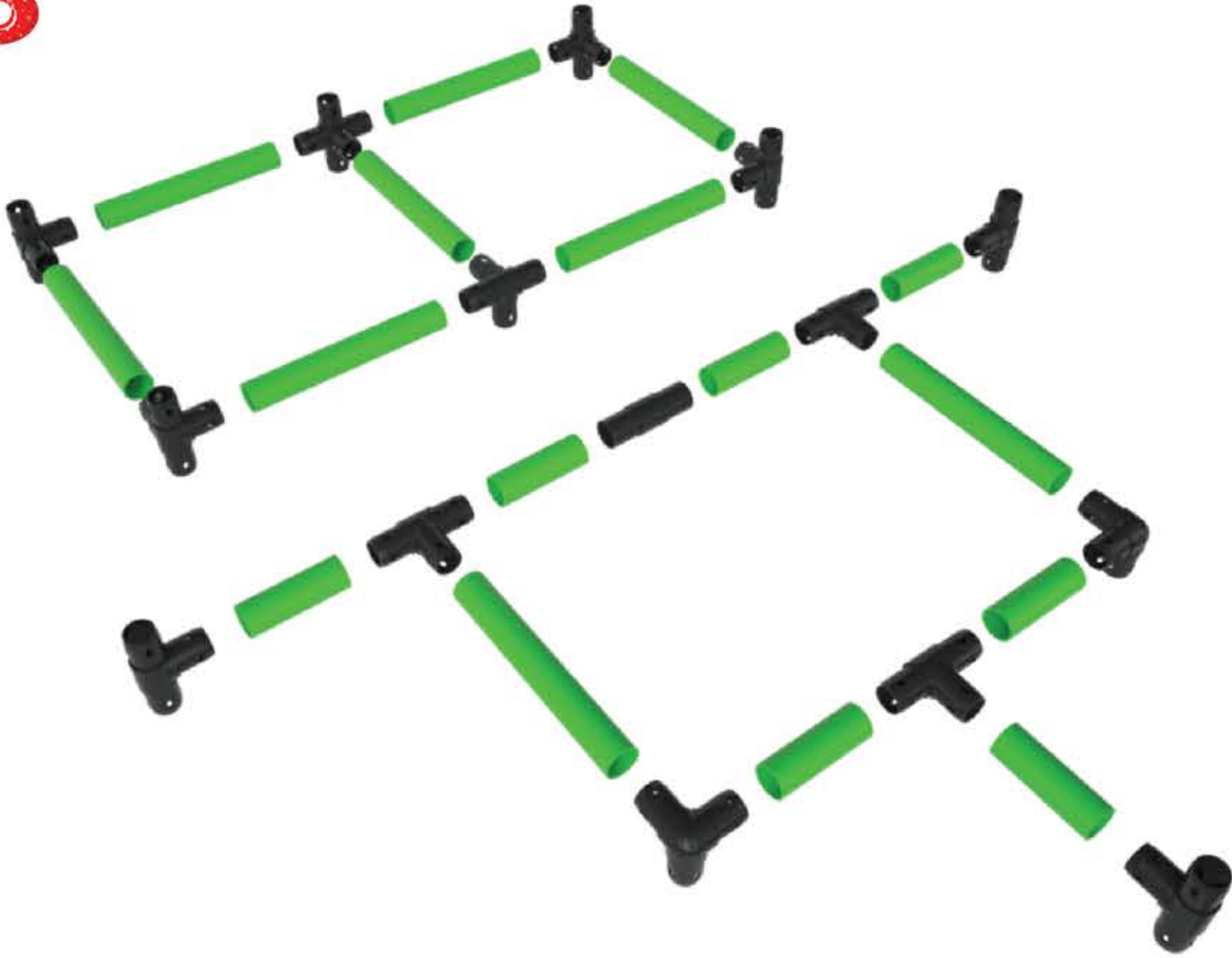

4









5

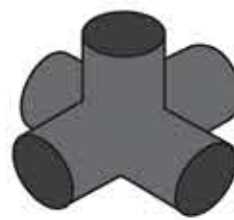
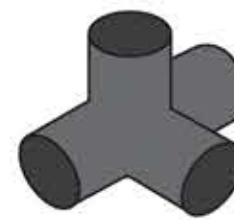
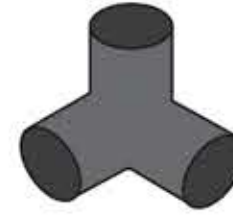

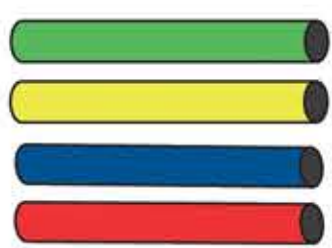
6

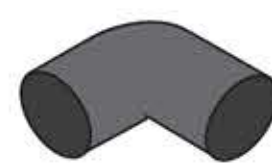

 2x	 19x	 6x	 7x	 4x
 50x	 3x	 1x	 6x	 13x

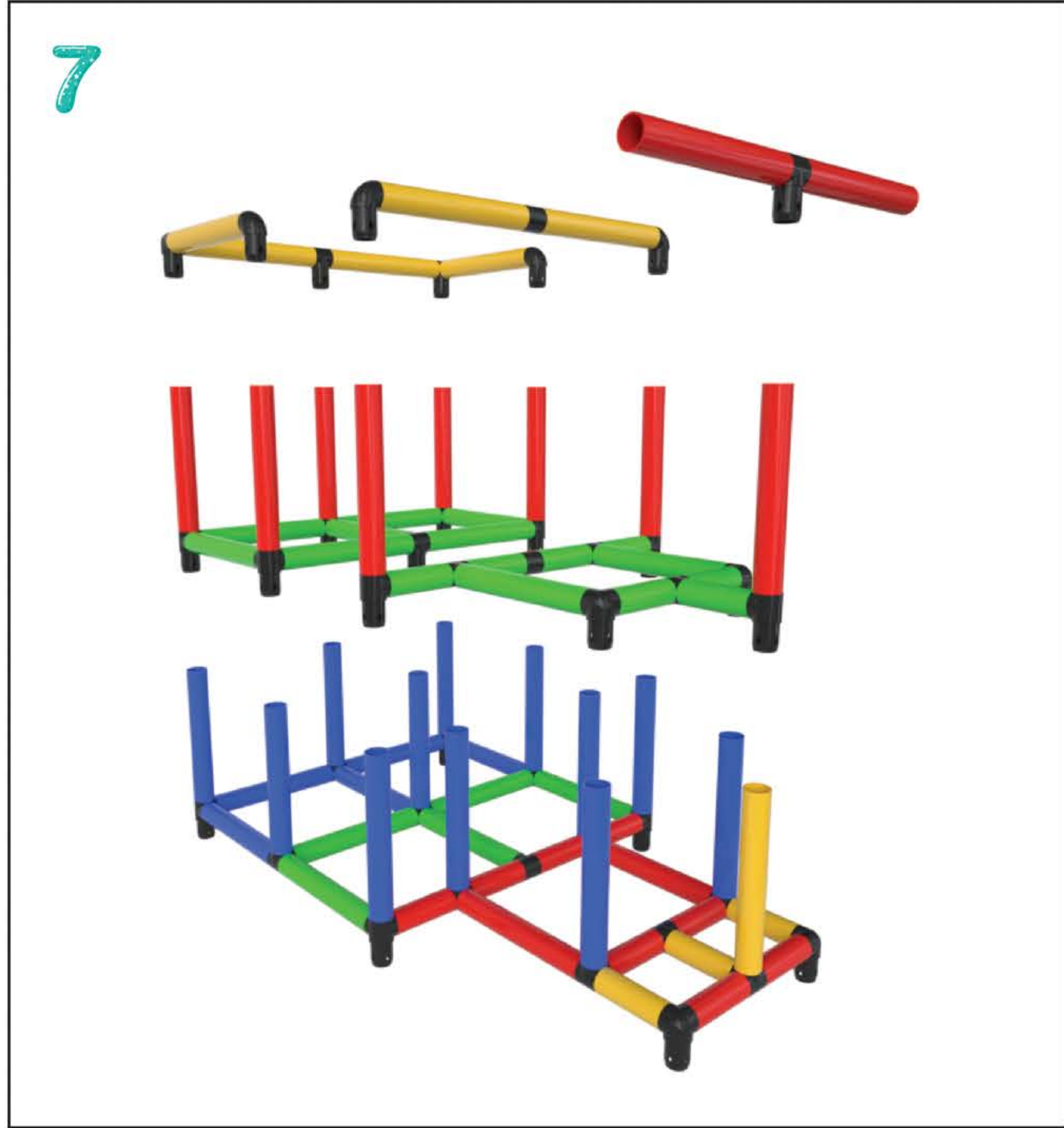



16x

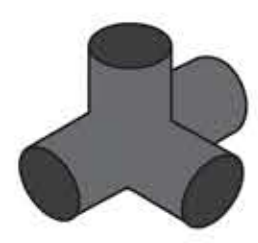

16x

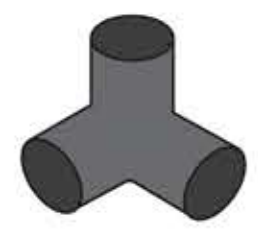

10x

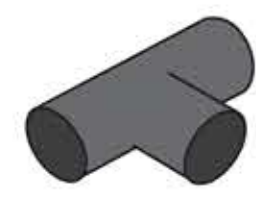

4x



18x



100x



9x



3x



10x



2x

Slide

1

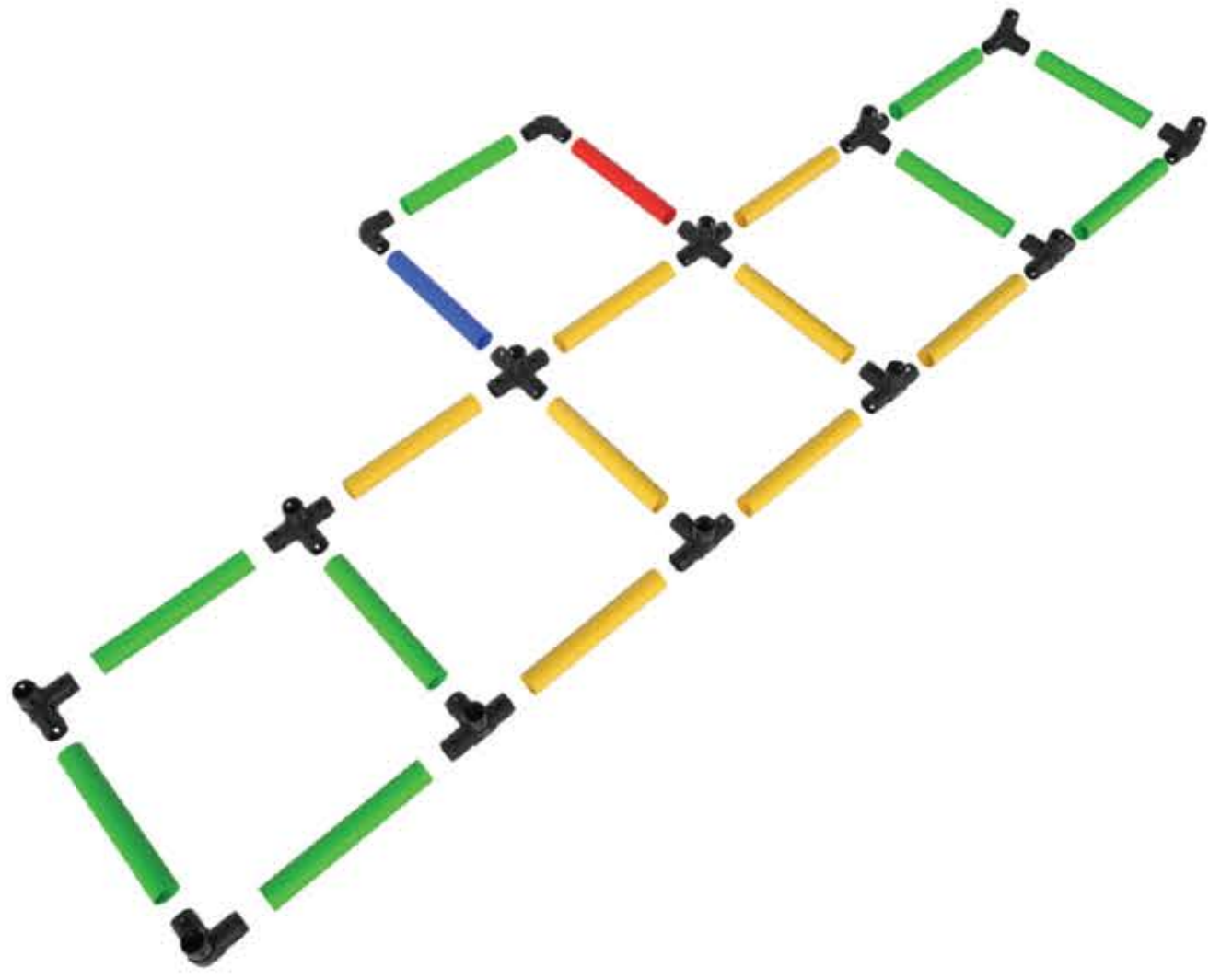

2

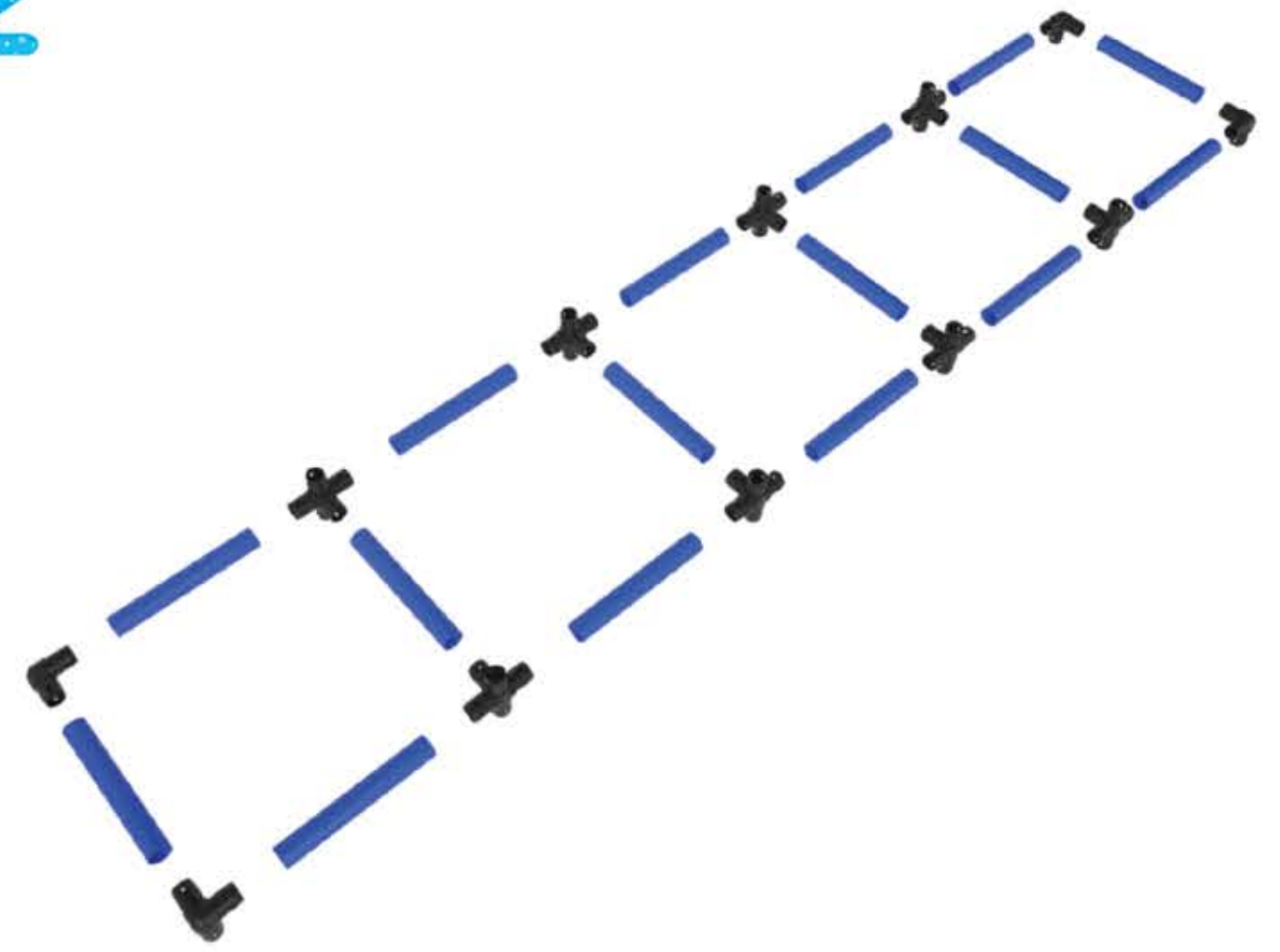

3

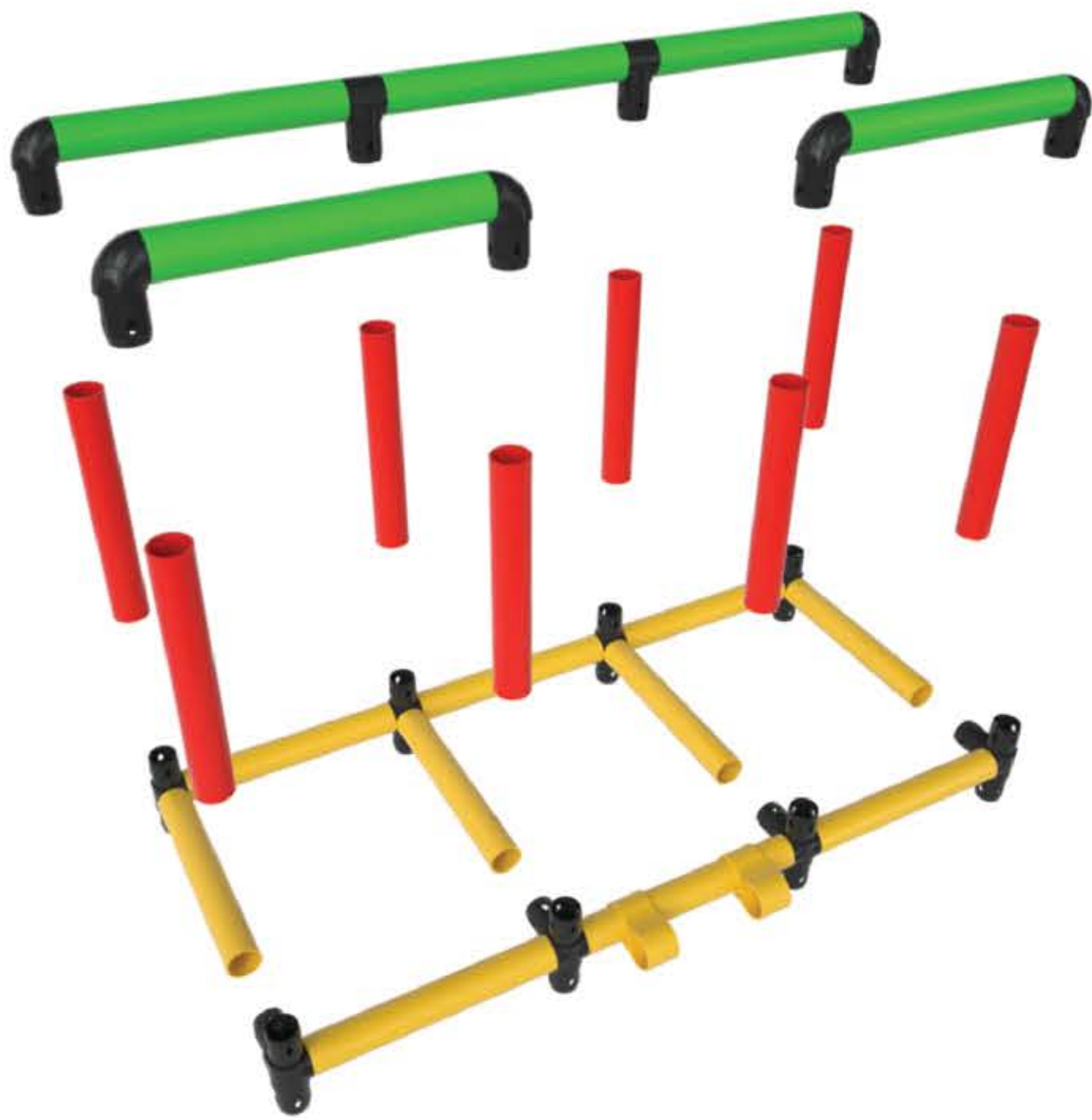

4

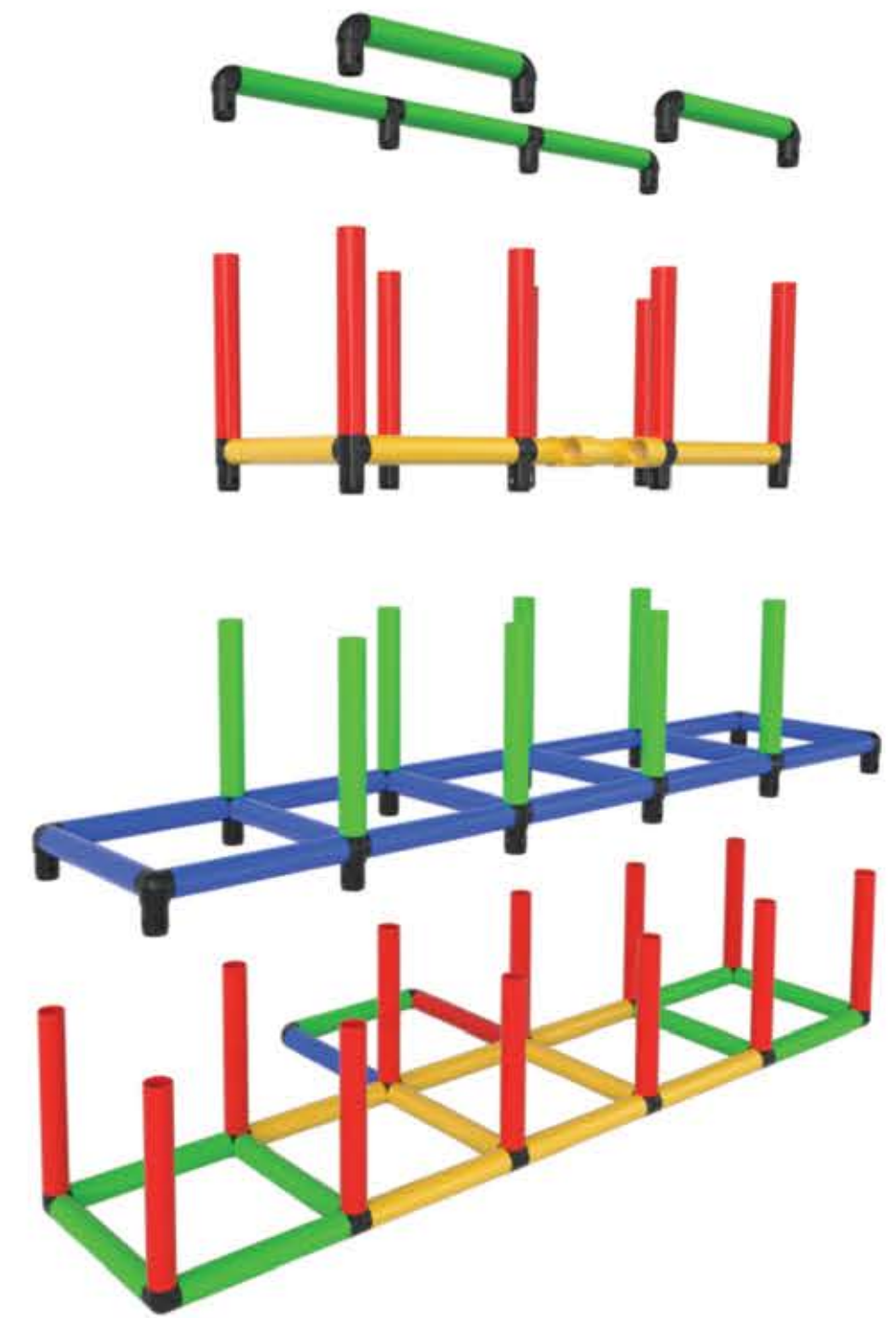

5

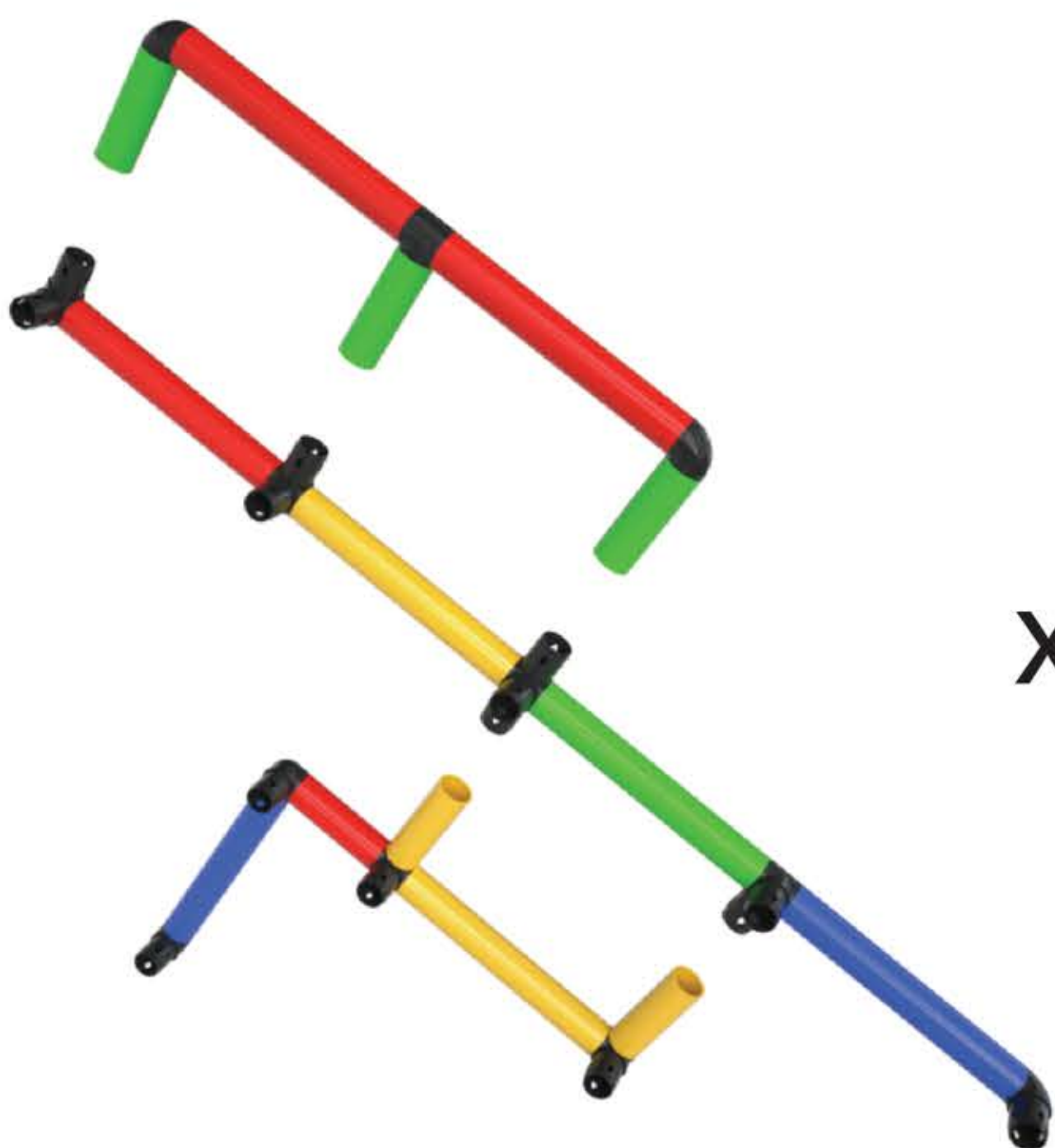

x2

6

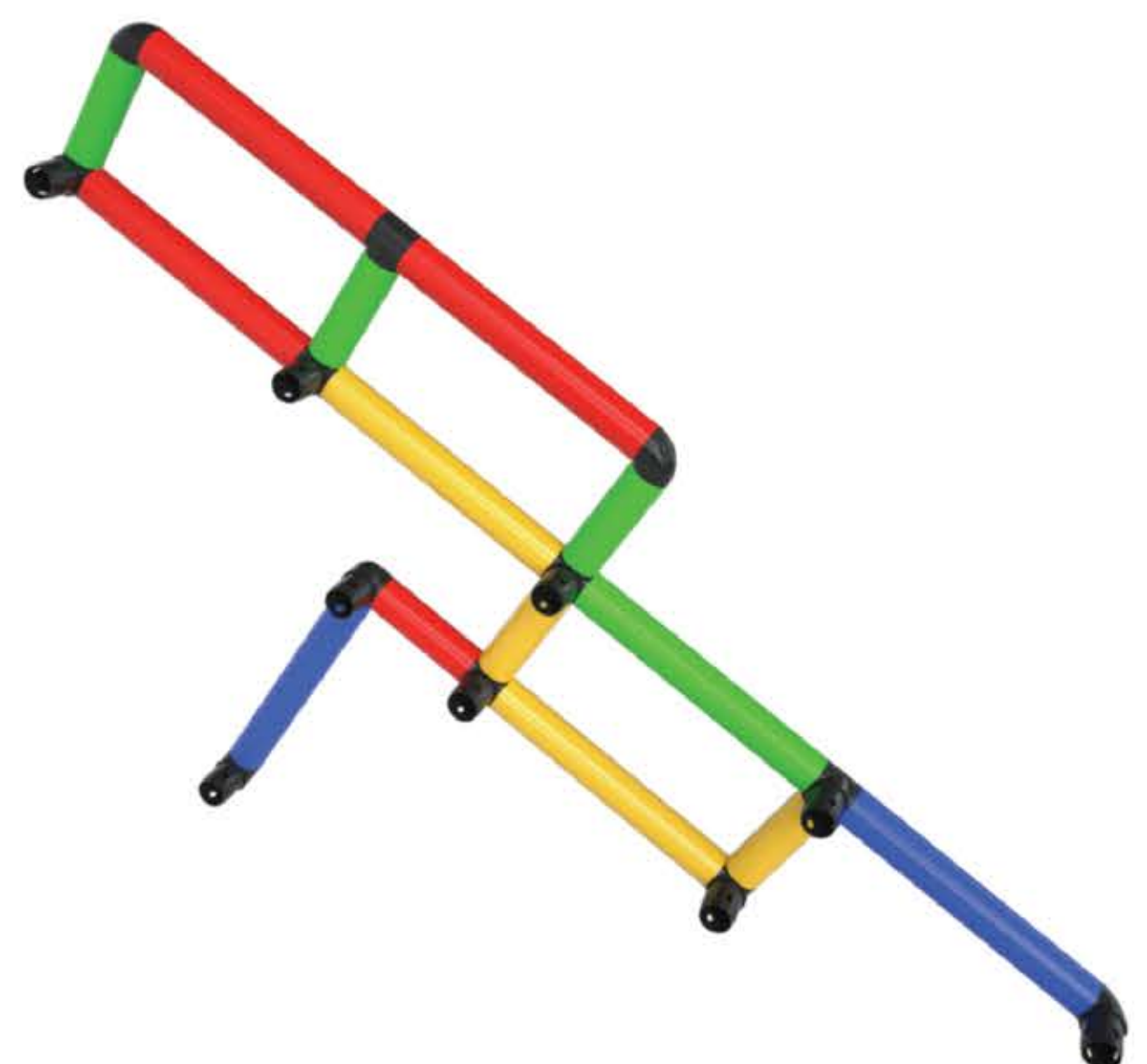

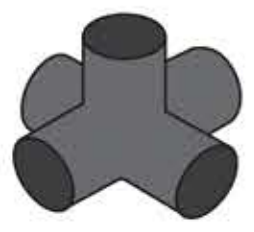

16x

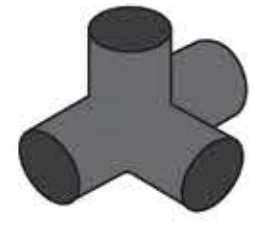

16x

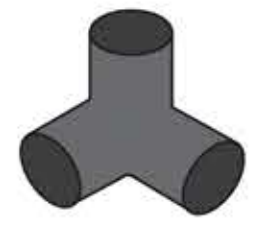

10x



4x



18x

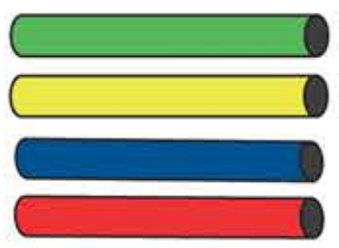

100x



9x



3x

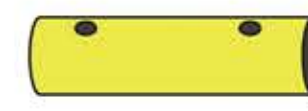

10x



2x

Slide

7

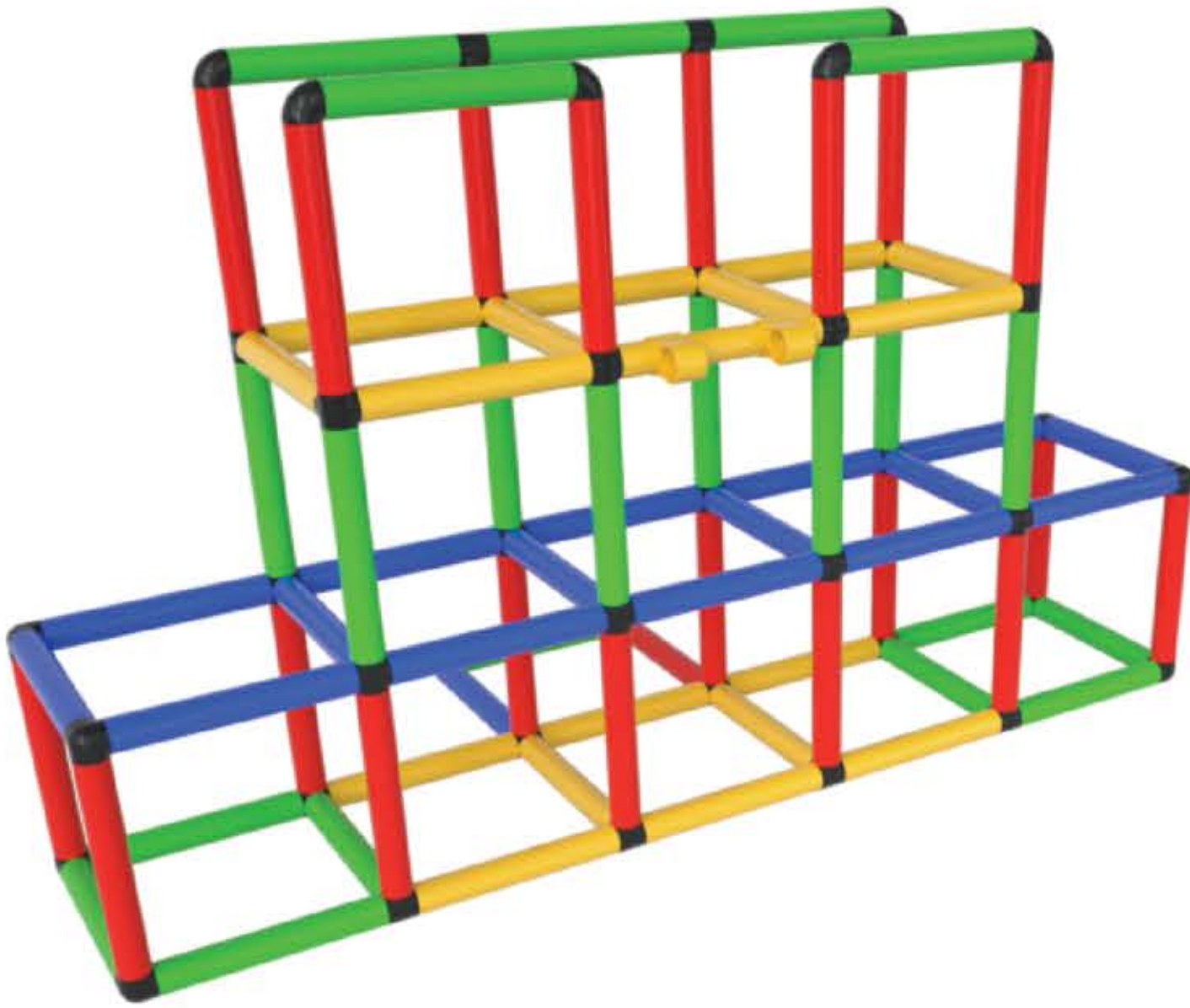

8

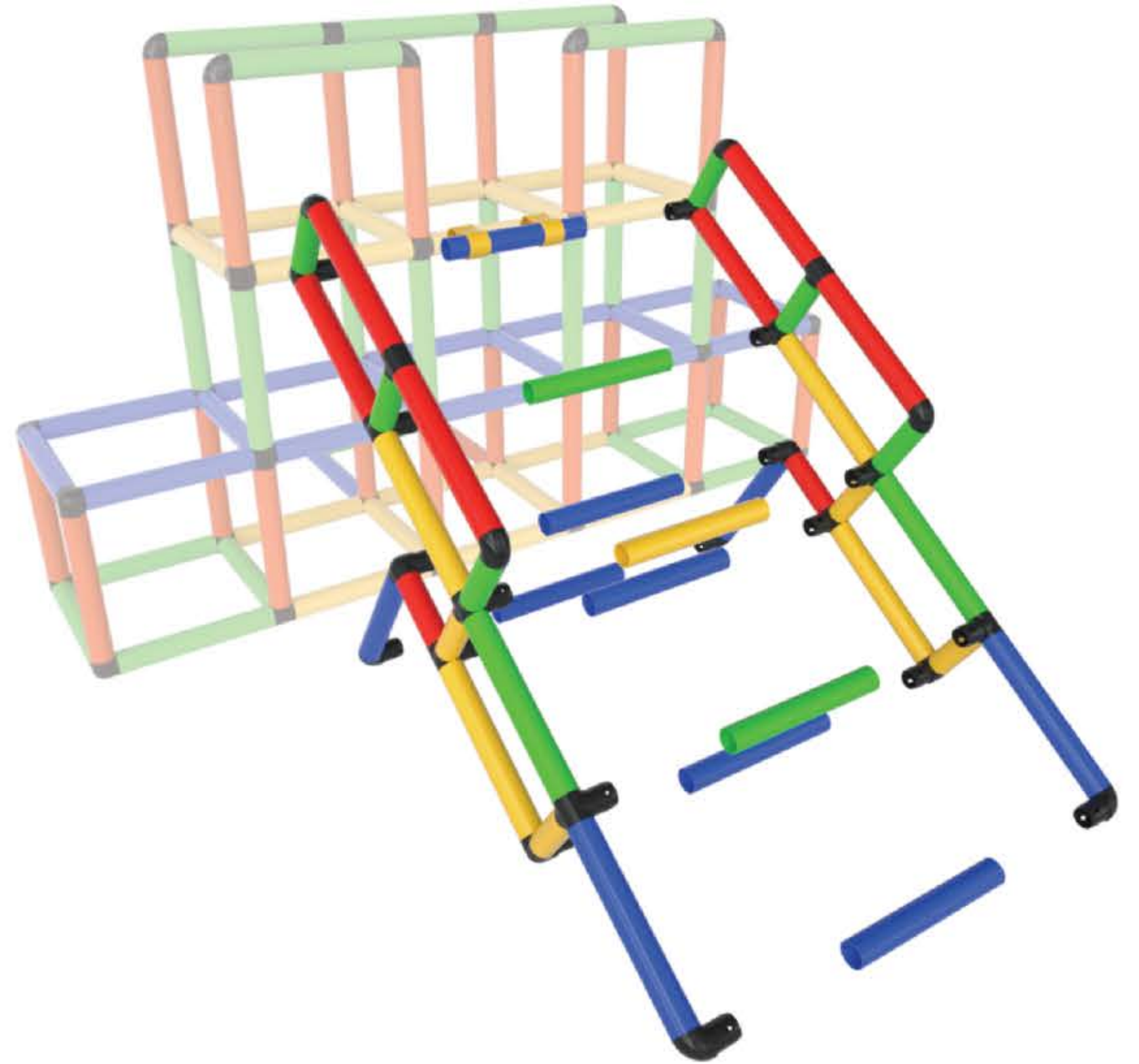

9

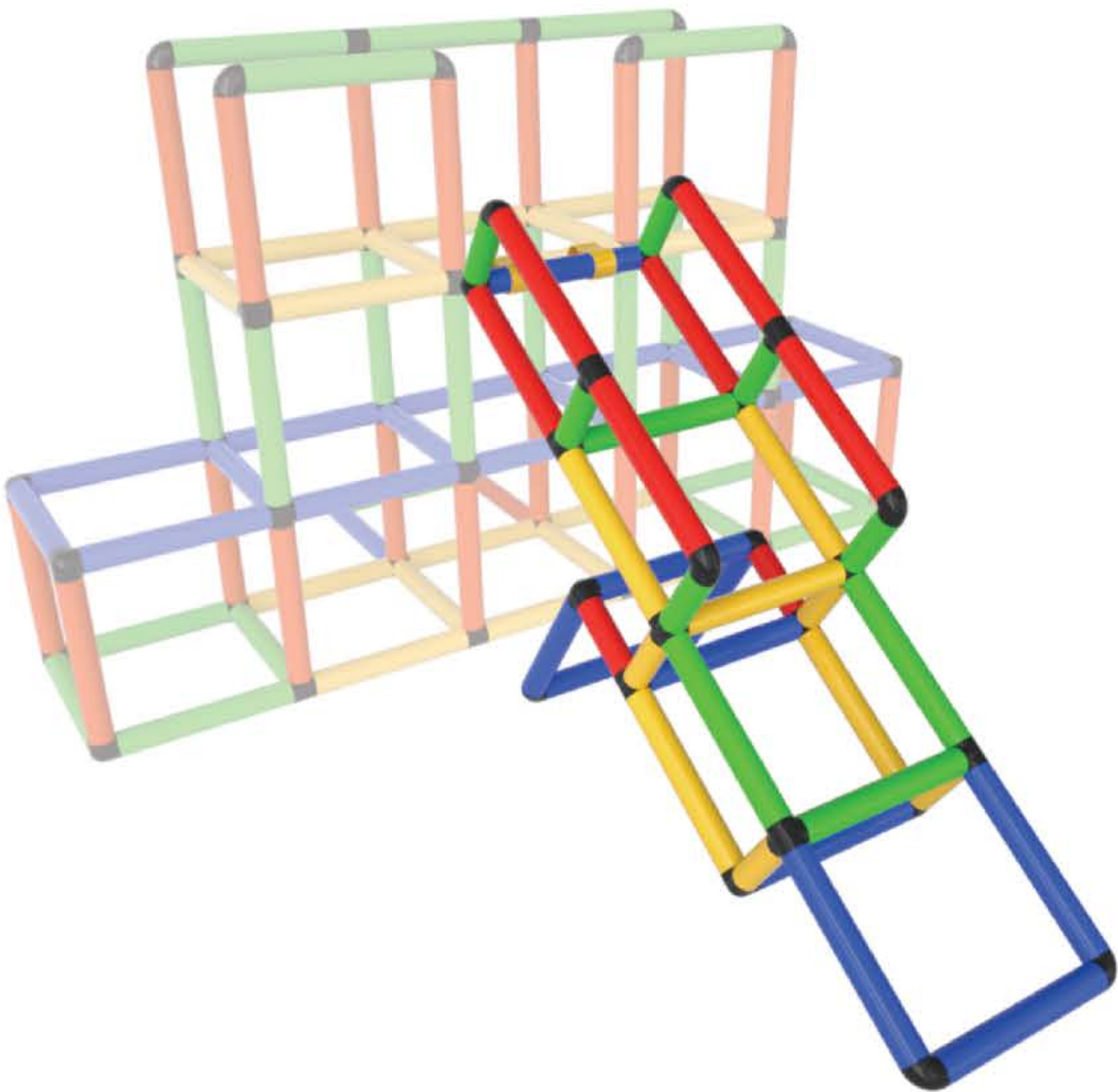

10

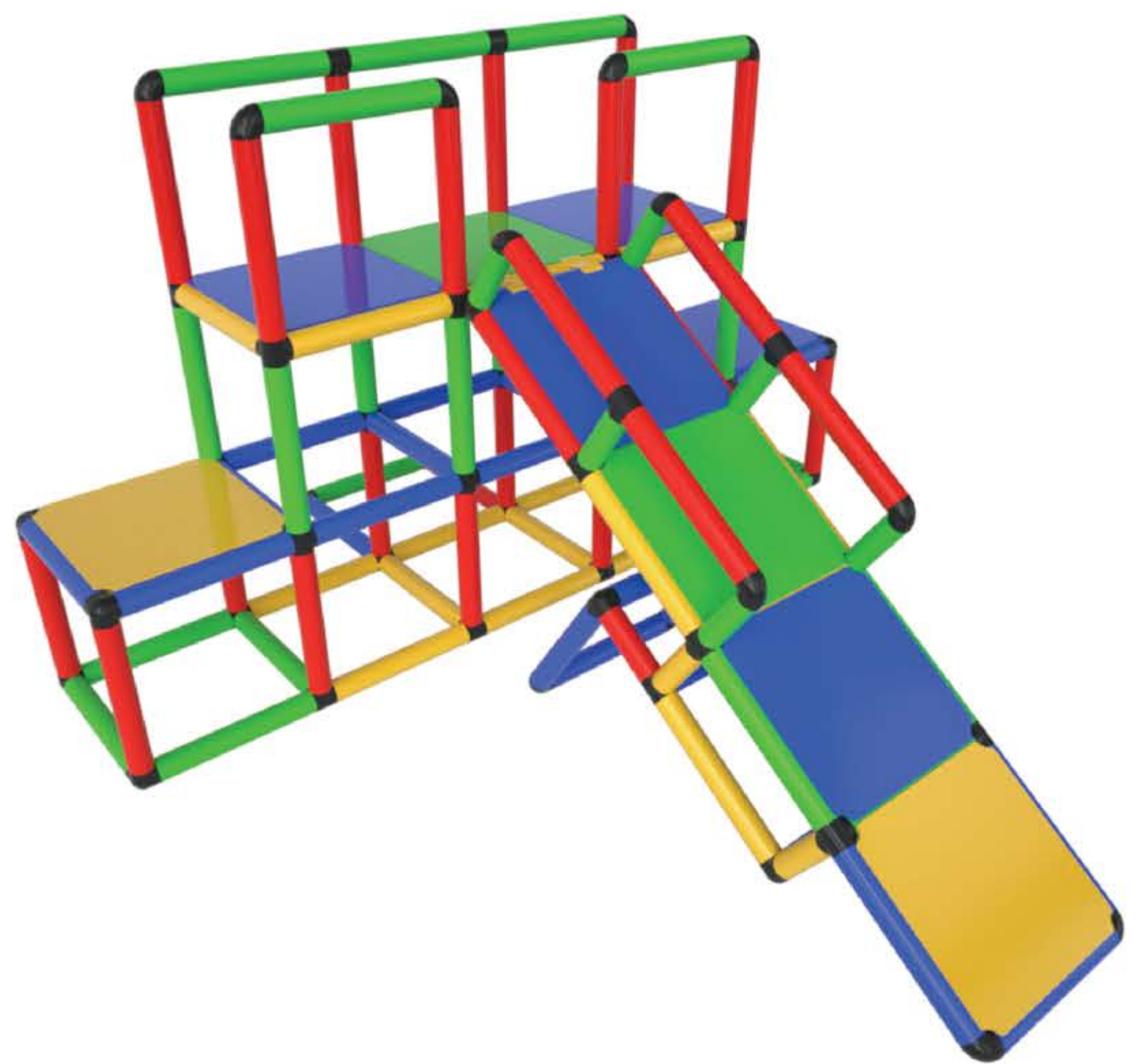

Insert Screws and Panels
and Secure all Screws

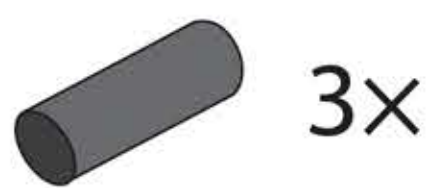
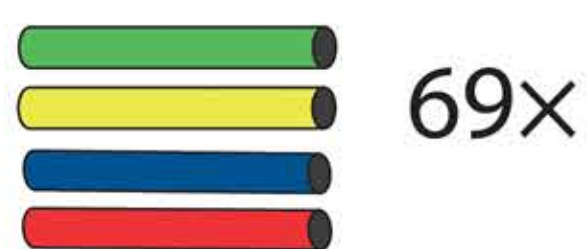
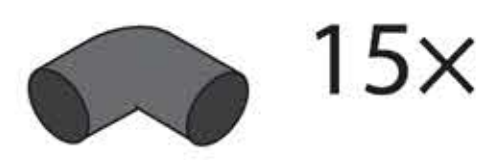
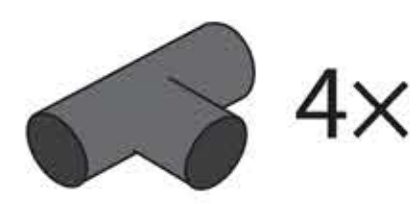
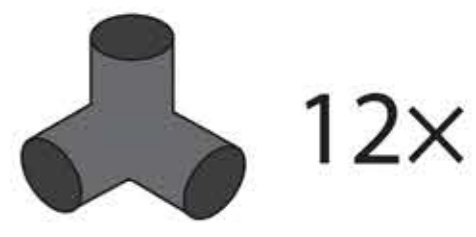
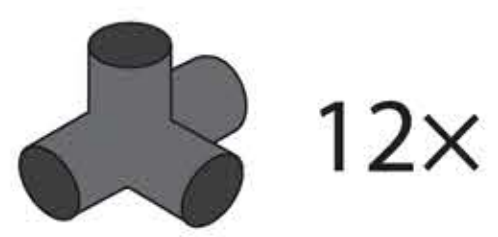
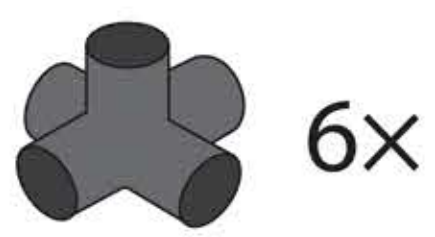

Escalators

1

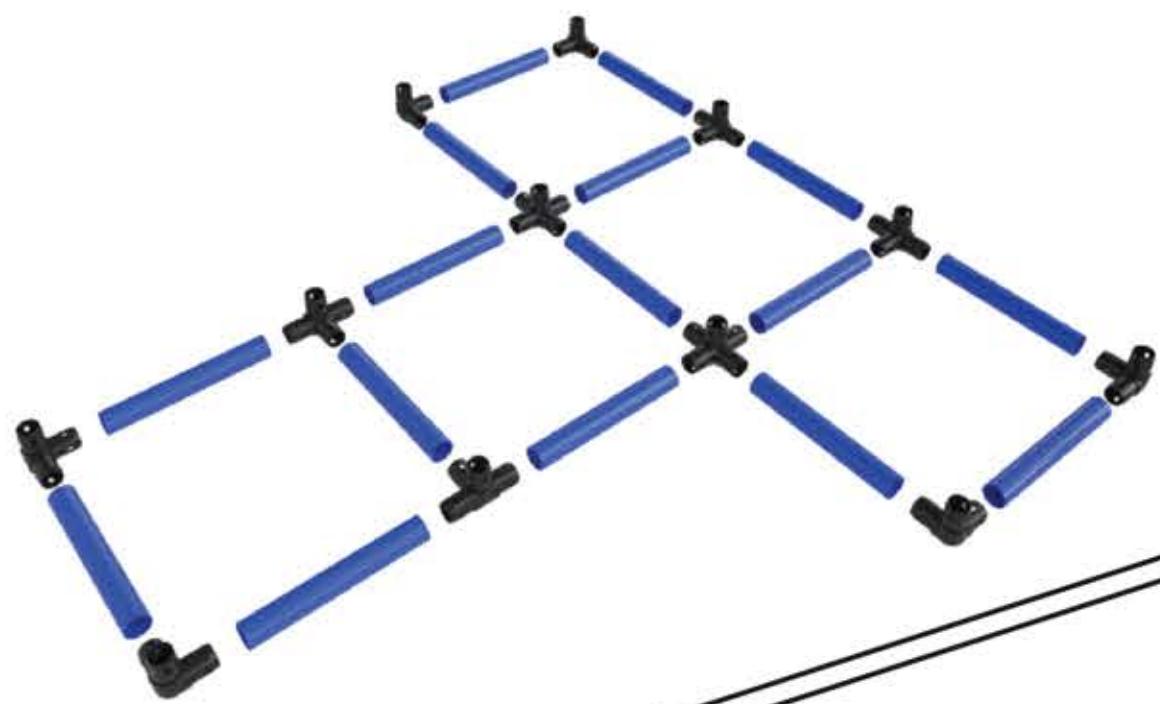

2

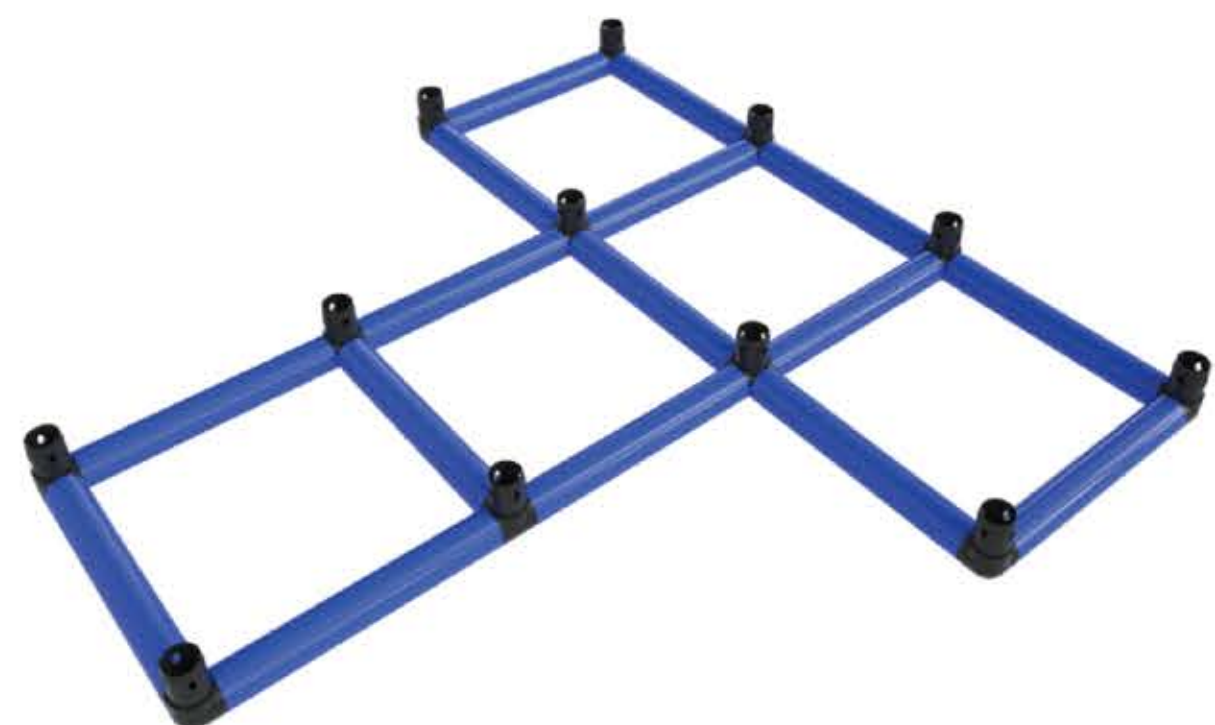

3

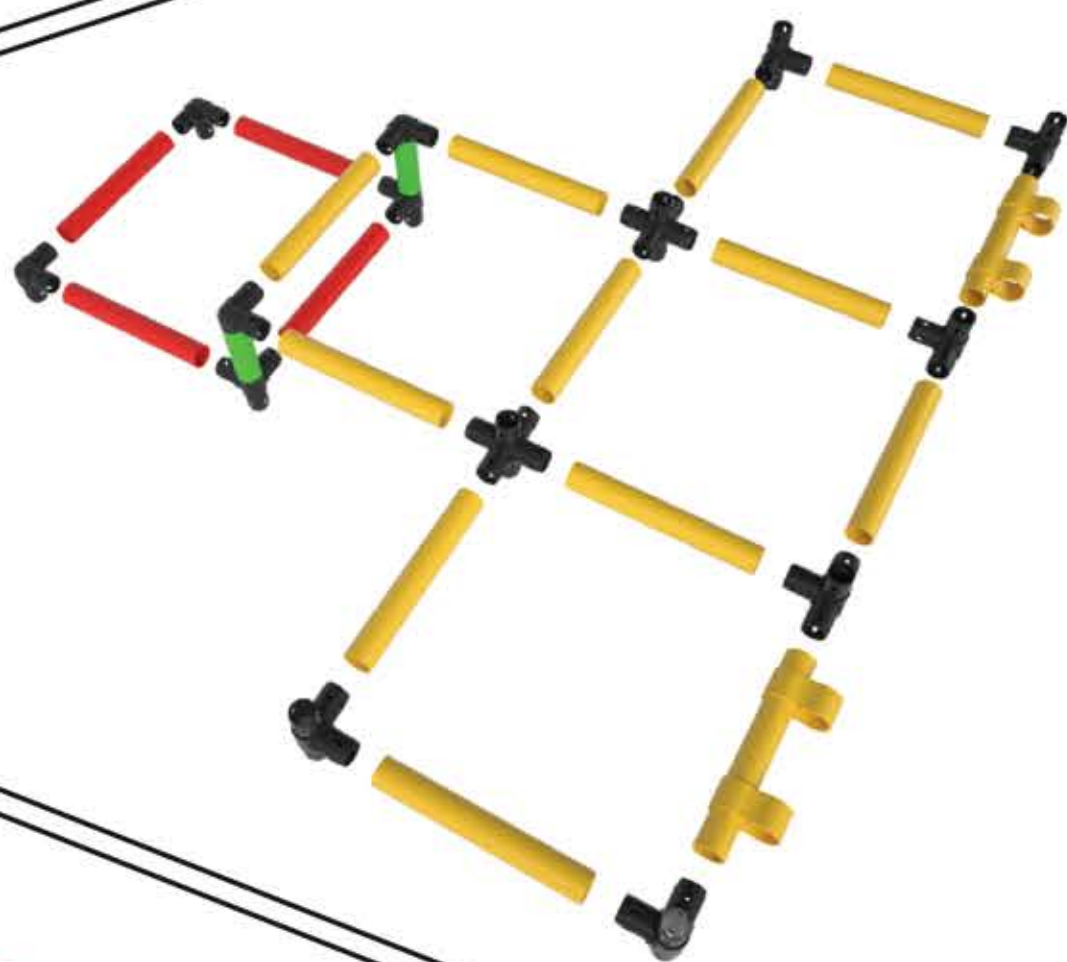

4

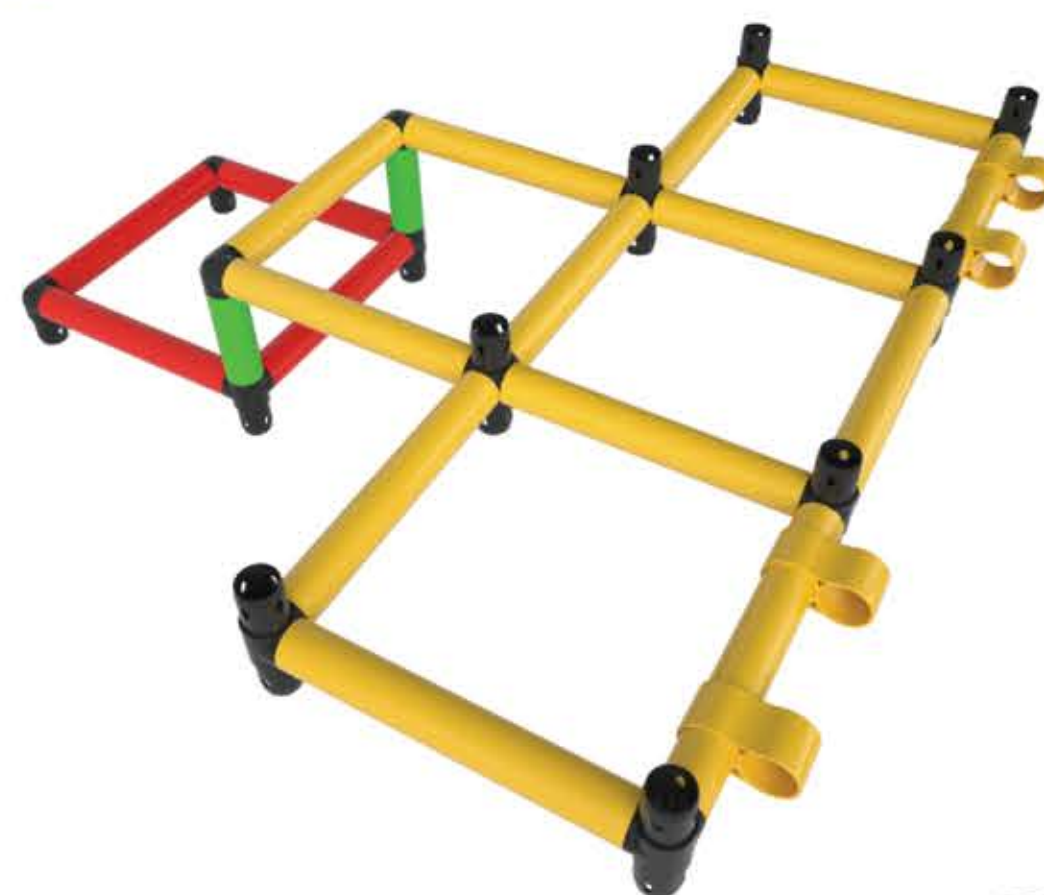

5

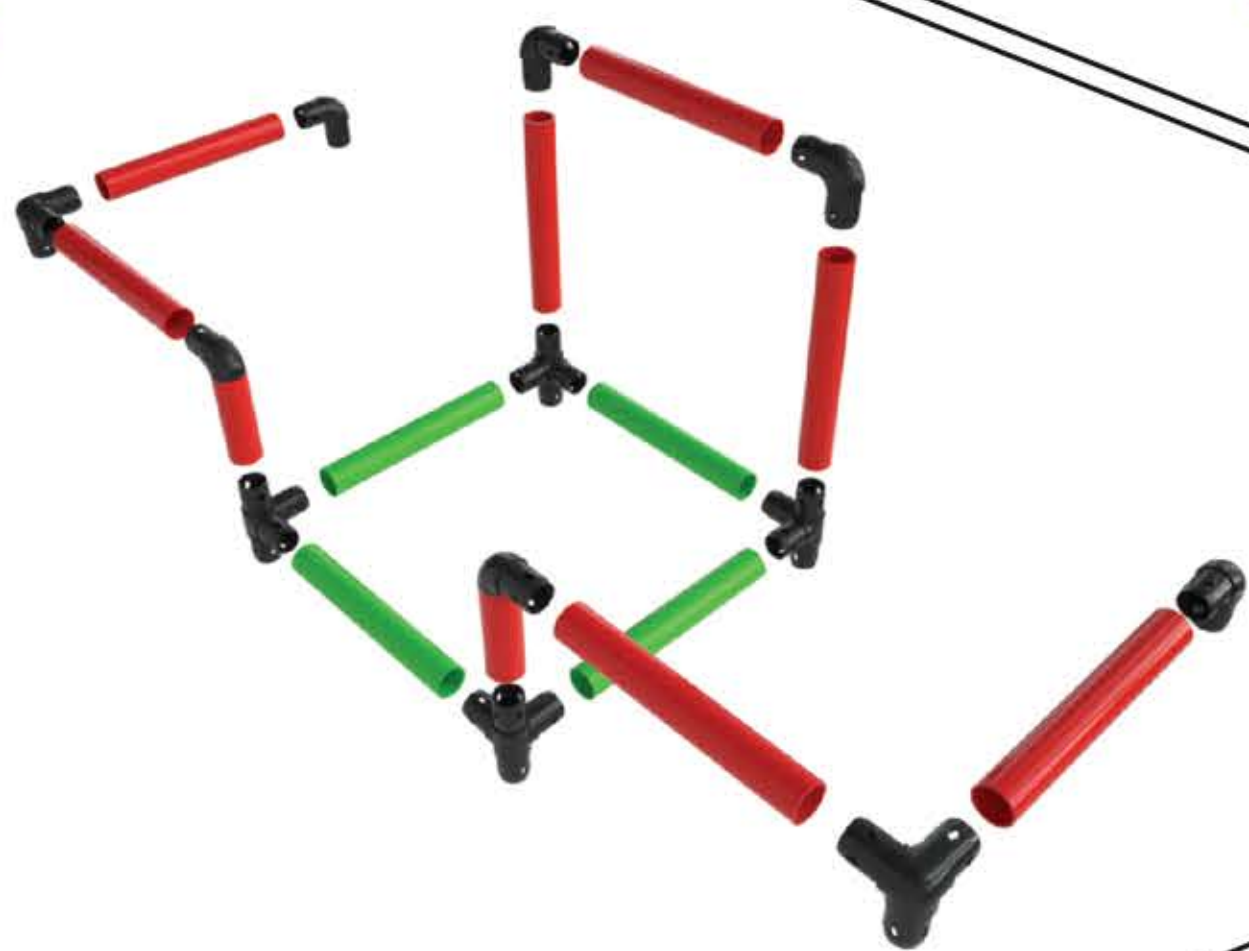

6

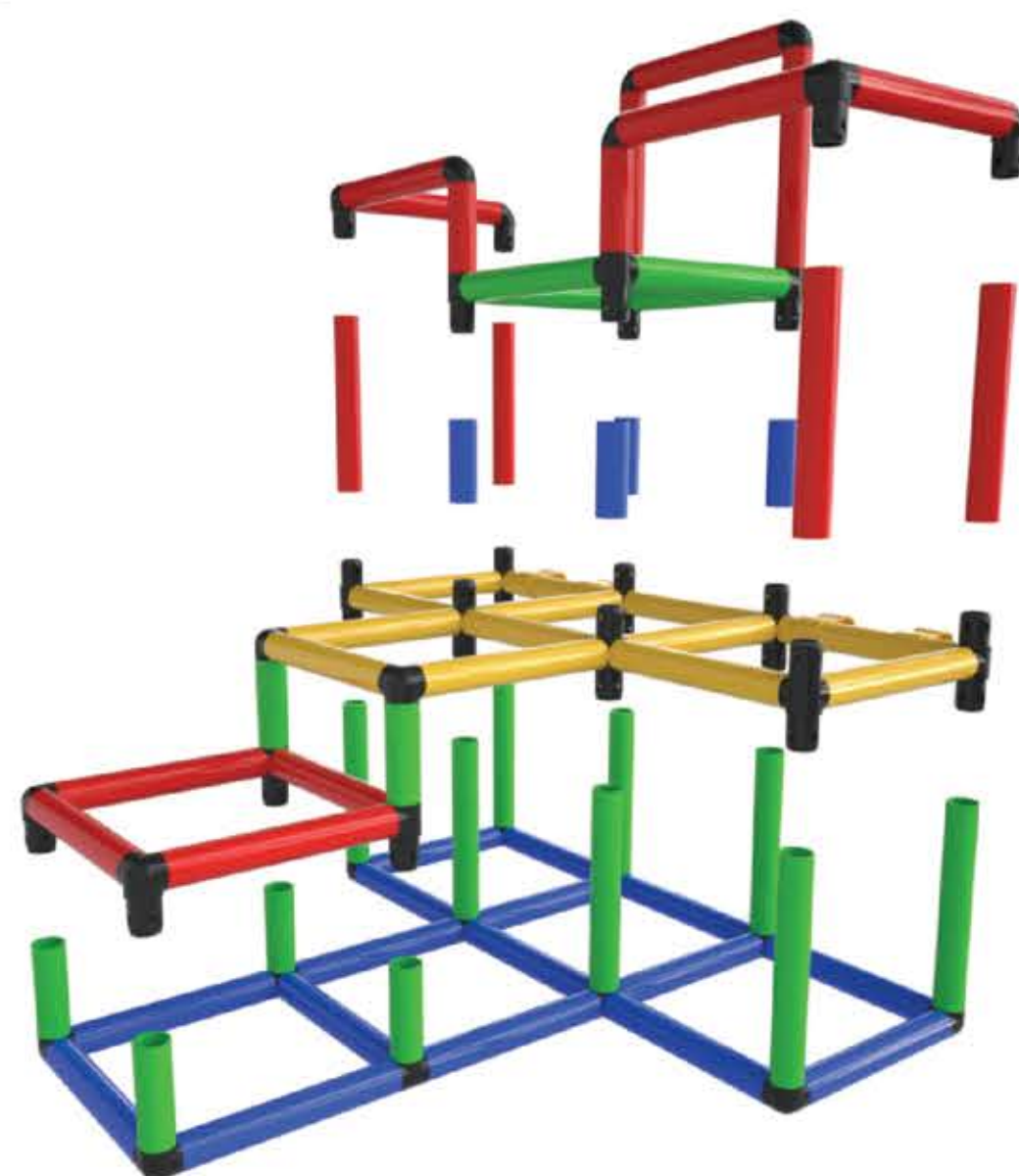

7

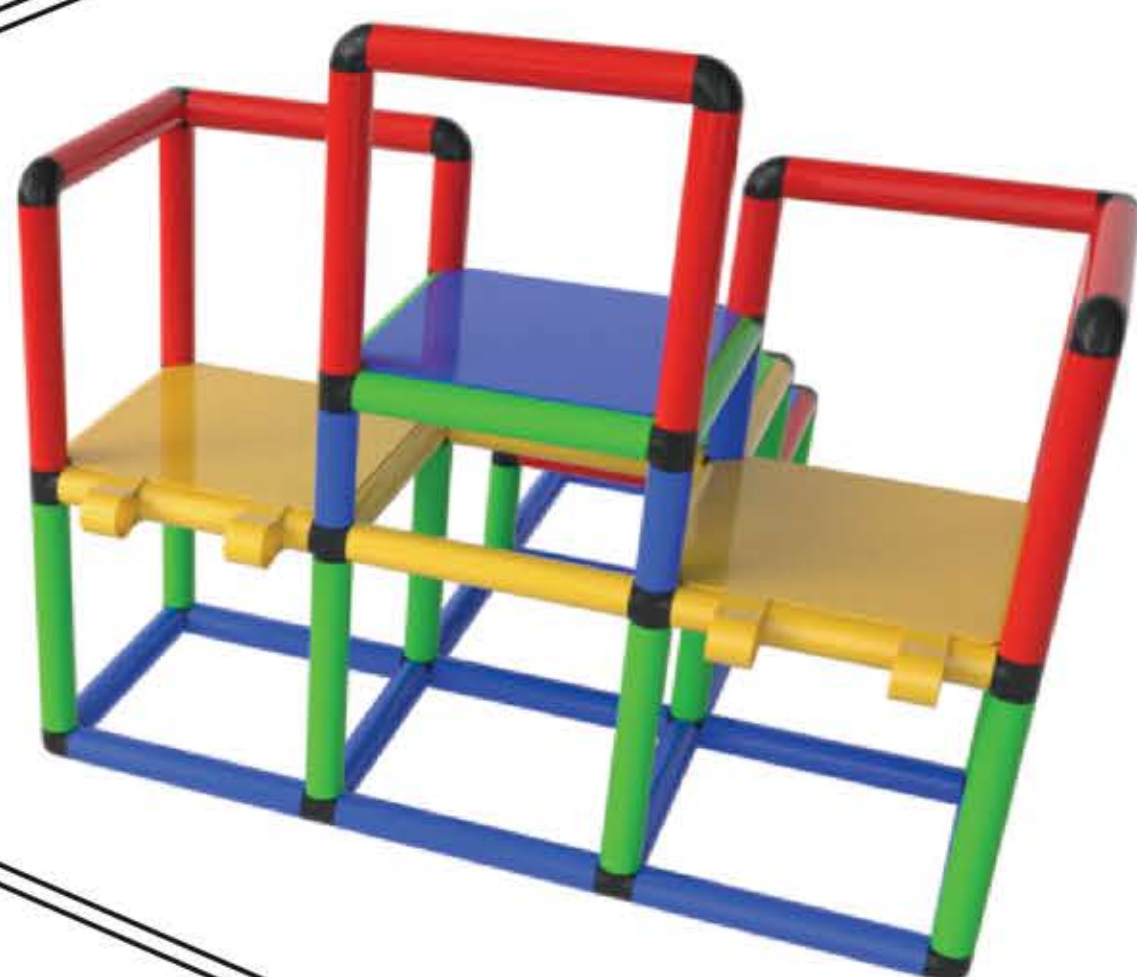

8



9

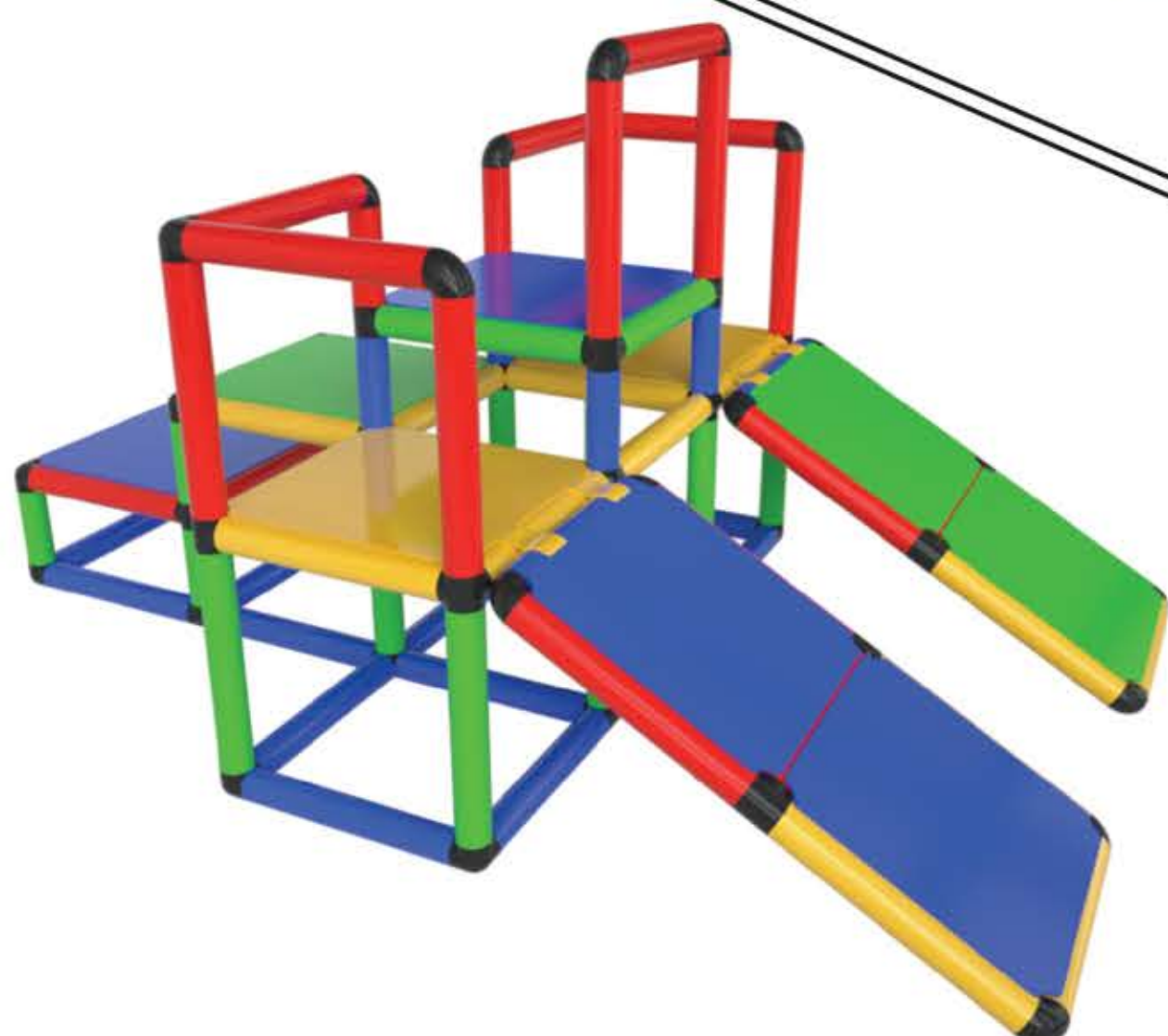

Insert Screws and Panels and Secure all Screws

2x



11x

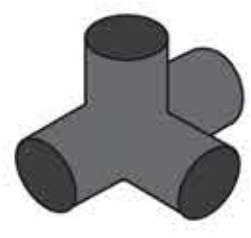

14x

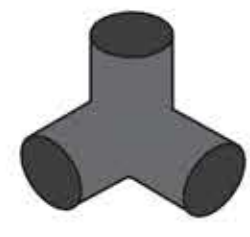

28x



91x

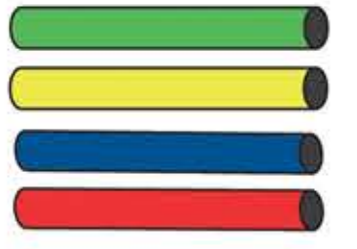

8x



15x



4x

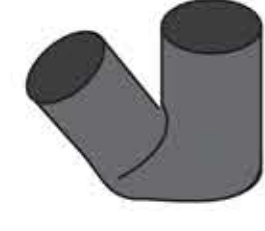

Cottage

1

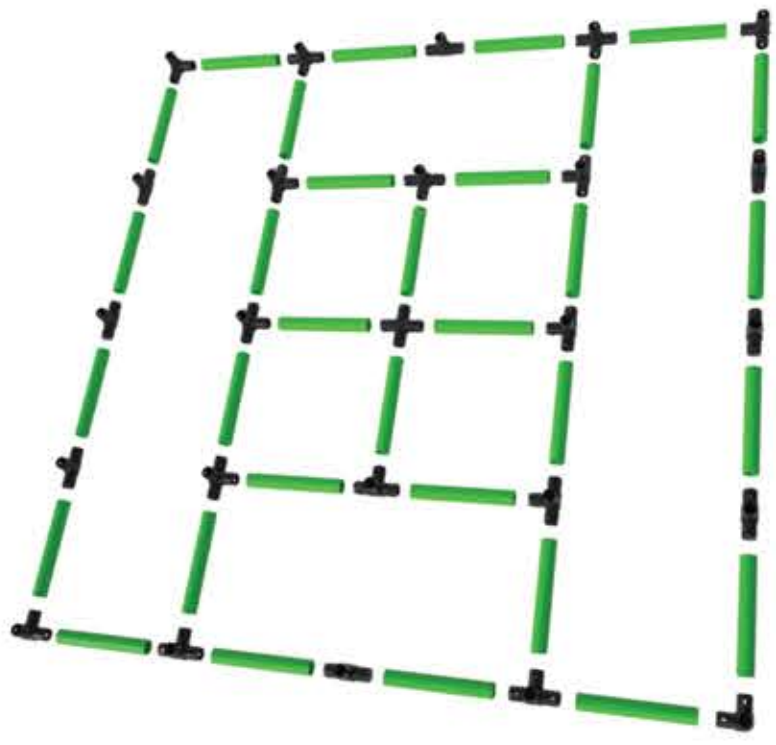

2

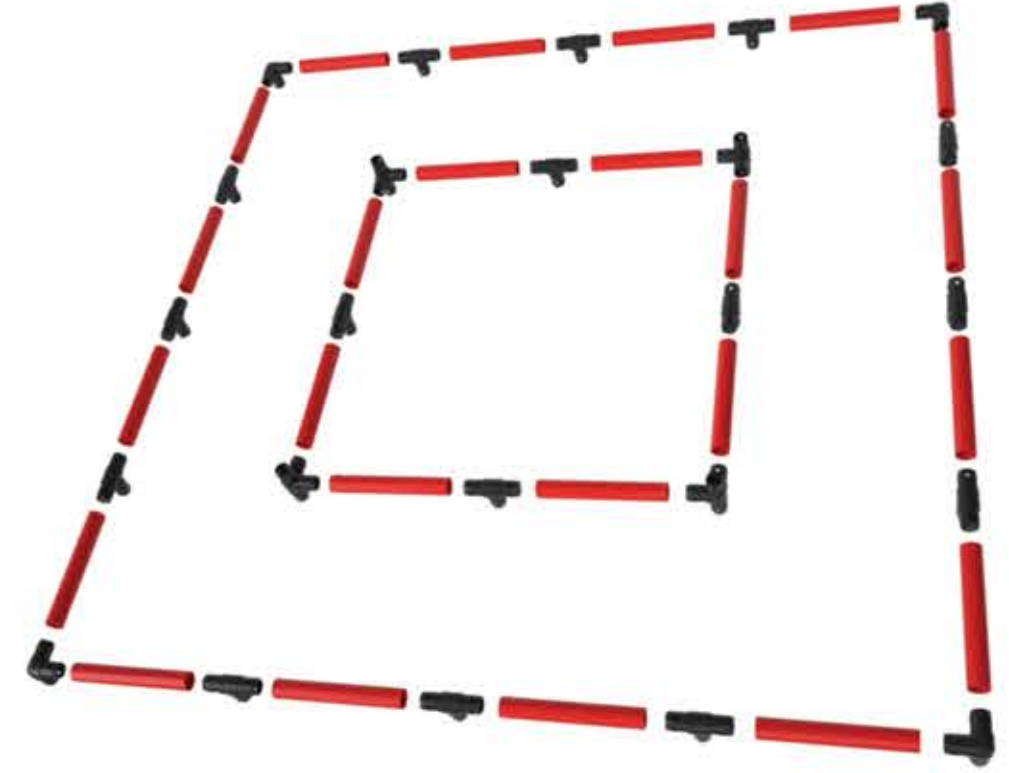

3



5

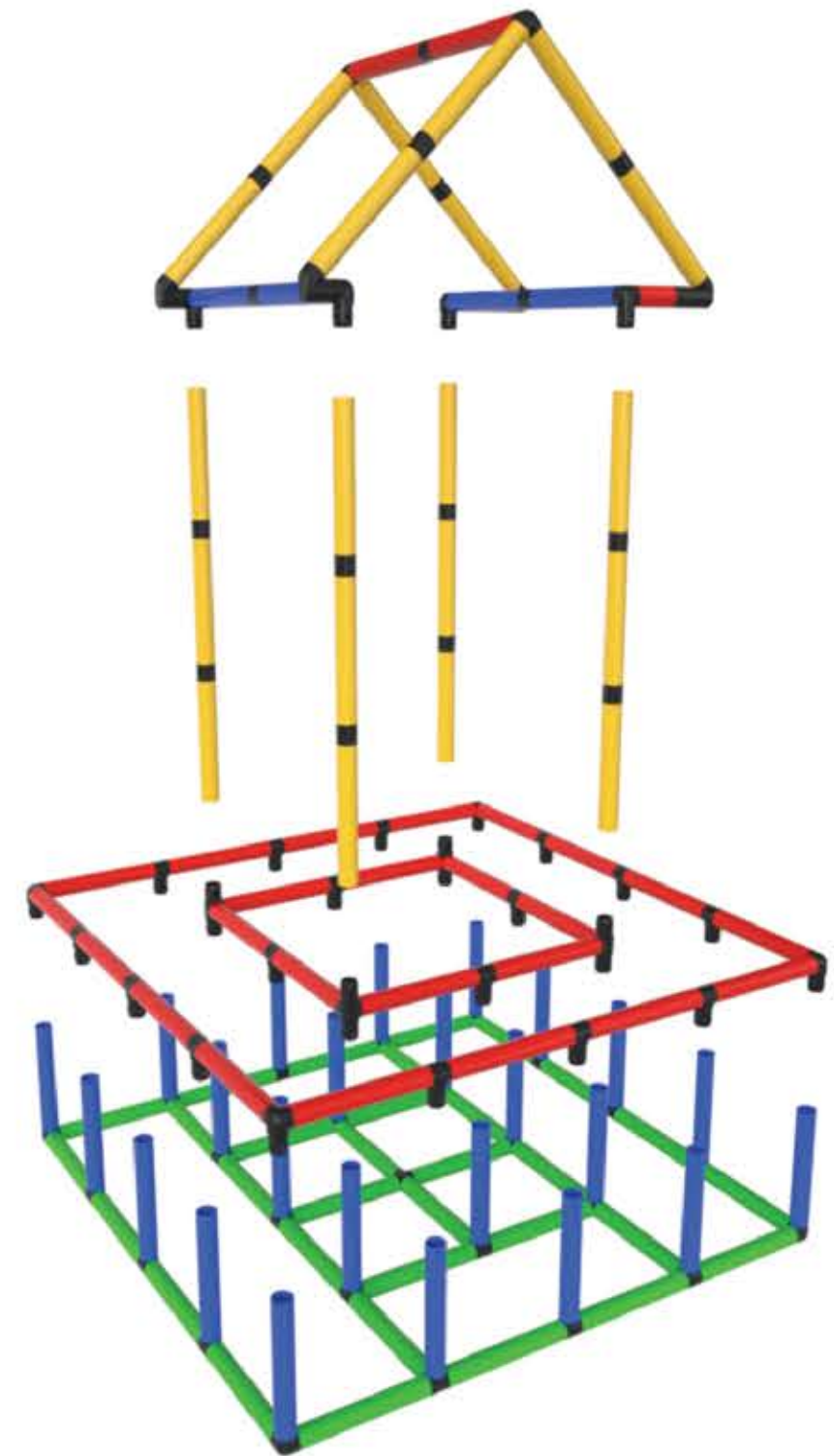

4



6

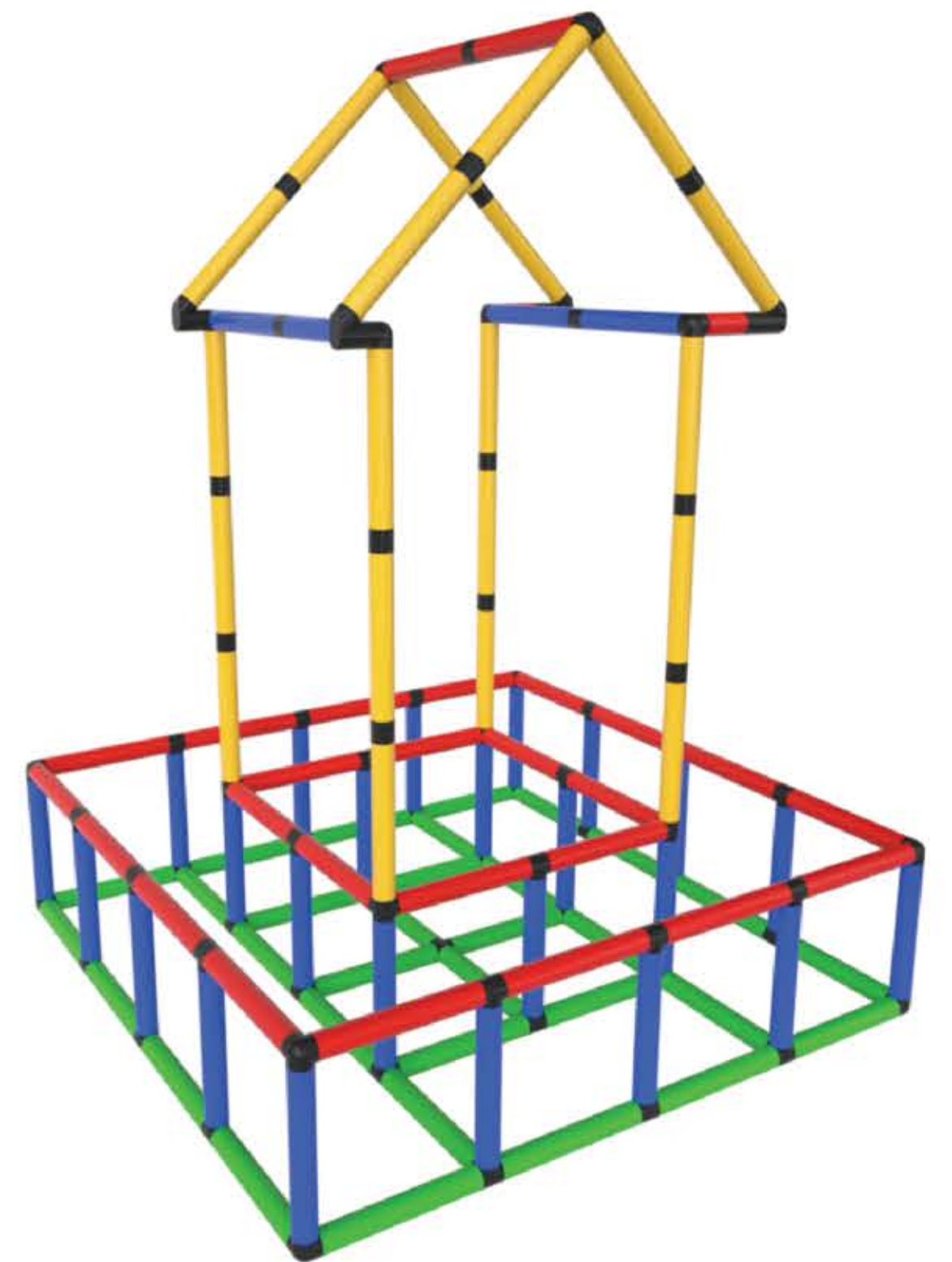

7



Insert Screws and Panels and Secure all Screws

To explore all our additional items and for more information check out our website

www.funphix.com

Feel free to contact our friendly staff for any questions or additional information at
support@funphix.com



Build with it - Play on it™

© Funphix, All Rights Reserved.